

MATHEMATISCHES FORSCHUNGSINSTITUT OBERWOLFACH

Report No. 4/2018

DOI: 10.4171/OWR/2018/4

## Strongly Correlated Random Interacting Processes

Organised by  
Ron Peled, Tel Aviv  
Vladas Sidoravicius, New York/Shanghai  
Alexandre Stauffer, Bath

28 January – 3 February 2018

ABSTRACT. The focus of the workshop was to discuss the recent developments and future research directions in the area of large scale random interacting processes, with main emphasis in models where local microscopic interactions either produce strong correlations at macroscopic levels, or generate non-equilibrium dynamics. This report contains extended abstracts of the presentations, which featured research in several directions including self-interacting random walks, spatially growing processes, strongly dependent percolation, spin systems with long-range order, and random permutations.

*Mathematics Subject Classification (2010):* 60K35, 82B20, 82C41.

### Introduction by the Organisers

The workshop *Strongly Correlated Random Interacting Processes*, organised by Ron Peled (Tel Aviv), Vladas Sidoravicius (NYU Shanghai), and Alexandre Stauffer (Bath) was held from January 28th – February 3rd 2018. The meeting was extremely well attended, with 53 participants from Brazil, Canada, China, Israel, the USA, and several European countries. The program consisted of 24 talks, with each of the first three days having three talks in the morning and three talks in the afternoon. In the last two days, there were talks only in the morning, with the afternoon being reserved for discussion between the participants. The goal of the talks were twofold: to present recent breakthrough results in a wide array of topics, and to unveil important challenges to be addressed in the near future in the area of strongly correlated random processes. Below we survey the program of the workshop.

The first day started with *Daniel Kiouss*, who showed a characterization for recurrence and transience of once-reinforced random walks on trees in terms of a quantity called the branching-ruin number, establishing for the first time the presence of a phase transition for this challenging model of self-interacting random walk. Then *Yinon Spinka* presented a condition for a general class of discrete spin systems to exhibit long-range order, resolving fundamental open questions for the anti-ferromagnetic Potts, Widom-Rowlinson and other models. The morning session ended with a talk by *Elisabetta Candellero* on first-passage percolation in a hostile environment, a fascinating model that not only plays a very important role in the understanding of multi-particle diffusion limited aggregation but also undergoes important phase transitions. She showed, for the first time in this model, the occurrence of coexistence when the underlying graph is non-amenable and hyperbolic, even if one type spreads much faster than the other. In the afternoon session, *Fabio Martinelli* discussed universality results for kinetically-constrained models, which are tightly connected to beautiful universality results on bootstrap percolation. Then *Tom Hutchcroft* analyzed the fundamental model of self-avoiding random walks on nonunimodular transitive graphs, showing convergence of the bubble diagram at criticality and ballisticity of the walker. The last talk of the first day was given by *Dmitry Ioffe*, who discussed a surprising phenomenon of uphill diffusions in which particles move from regions of low density to regions of high density.

In the second day, *Pietro Caputo* discussed a detailed analysis of the mixing time, including a proof of the cutoff phenomenon, for sparse non-reversible Markov chains, a quite challenging case since no explicit form for the stationary distribution is available. *Alessandra Cipriani* discussed the scaling limit and further recent developments in the study of the membrane model and *Vincent Tassion* presented exciting progress in the understanding of three-dimensional percolation, showing that there are no exceptional words when  $p$  is between  $p_c$  and  $1 - p_c$ . The afternoon session started with *Senya Shlosman* who explained how a continuum of extremal Gibbs states arises for the Ising model on a tree, utilizing free boundary conditions, and on the half-plane endowed with Dobrushin boundary conditions. This was followed by *Daniel Ueltschi* who presented detailed results for the random interchange model on the complete graph tilted by a factor  $\theta$  to the number of cycles, with  $\theta \geq 2$  integer. The second day ended with *Titus Lupu* who discussed recent results on vertex-reinforced jump processes.

The third day started with *Hugo Duminil-Copin* who reviewed the random walk and percolation interpretation of the Ising spin-spin correlations and outlined how these can be applied to prove triviality of the scaling limit in four dimensions. *Yvan Velenik* presented precise asymptotics of Ornstein-Zernike type in the Ising model, for the covariance between two products of an even number of spins. *Alain-Sol Sznitman* discussed the appearance of macroscopic holes in some models of strongly dependent percolation, such as the vacant set of random interlacements and the excursion set above a given level of the Gaussian free field. During the afternoon, *Lorenzo Taggi* discussed a model of spatial random permutations which

gives rise to a collection of loops, *Antal Jaraı* presented a series of open problems and challenges in the study of the Abelian sandpile model, and *Alexander Glazman* presented recent work on the existence of macroscopic loops in the loop  $O(N)$  model, rigorously verifying part of the conjectured phase diagram of the model.

The fourth day began with *Omer Angel*, who discussed a relation between the Mallows model of random permutations and stable matchings, and used it to obtain the scaling limit of the evolution of orbits in the Mallows permutation. Then *Peter Gracar* presented a general multi-scale framework, based on the Lipschitz percolation of local events, which is employed to analyze the spread of infection and other problems on a system of particles moving as independent random walks. The last talk of the day was by *Amanda Turner*, who presented new developments in and around the Hastings-Levitov model of random growth. The afternoon was free to foster discussions and collaborations among the participants.

The last day of the workshop featured a presentation by *Bálint Tóth* on the behavior of a random walk in a divergence-free random drift field, in which the walker may exhibit super-diffusive behavior or satisfy a quenched CLT. Then *Nick Crawford* discussed his recent result on the eigenvector correlations of non-Hermitian random matrices, and the workshop concluded with a talk by *Andrea Collevocchio*, who discussed a system of correlated random walks, whose step distribution is given by a cellular automaton.

On behalf of all participants, the organizers would like to thank the staff and the director of the Mathematisches Forschungsinstitut Oberwolfach for providing such a stimulating and inspiring atmosphere, and for taking care of all local arrangements with extreme efficiency.

*Acknowledgement:* The MFO and the workshop organizers would like to thank the National Science Foundation for supporting the participation of junior researchers in the workshop by the grant DMS-1641185, “US Junior Oberwolfach Fellows”. Moreover, the MFO and the workshop organizers would like to thank the Simons Foundation for supporting Ruriko Yoshida in the “Simons Visiting Professors” program at the MFO.



**Workshop: Strongly Correlated Random Interacting Processes****Table of Contents**

Daniel Kious (joint with Andrea Collecchio and Vladas Sidoravicius)	
<i>The branching-ruin number and the once-reinforced random walk</i> . . . . .	193
Yinon Spinka (joint with Ron Peled)	
<i>A condition for long-range order in discrete spin systems</i> . . . . .	195
Elisabetta Candellero (joint with Alexandre Stauffer)	
<i>First passage percolation in hostile environment (on hyperbolic graphs)</i> .	199
Fabio Martinelli (joint with Rob Morris and Cristina Toninelli)	
<i>On the infection time of kinetically constrained models: universality in two dimensions</i> . . . . .	200
Thomas Hutchcroft	
<i>Self-Avoiding Walk on <math>T \times \mathbb{Z}</math></i> . . . . .	203
Dmitry Ioffe	
<i>A toy model for uphill diffusion</i> . . . . .	203
Pietro Caputo (joint with Charles Bordenave and Justin Salez)	
<i>Cutoff at the “entropic time” for sparse Markov chains</i> . . . . .	204
Alessandra Cipriani (joint with Biltu Dan and Rajat Subhra Hazra)	
<i>The scaling limit of the membrane model</i> . . . . .	205
Vincent Tassion (joint with Pierre Nolin and Augusto Teixeira)	
<i>No exceptional word in Bernoulli percolation</i> . . . . .	207
Senya Shlosman	
<i>The free Ising state on the tree: continual decomposition into extremals</i>	208
Daniel Ueltschi	
<i>Random interchange model and Poisson-Dirichlet distribution</i> . . . . .	210
Titus Lupu (joint with Christoph Sabot and Pierre Tarres)	
<i>Fine mesh limit of 1D VRJP, inversion of Ray-Knight and Bass-Burdzy flows</i> . . . . .	211
Hugo Duminil-Copin (joint with M. Aizenman, V. Tassion and S. Warzel)	
<i>Emerging planarity of Pfaffian structures of the long-range Ising model</i> .	212
Yvan Velenik (joint with Sébastien Ott)	
<i>Asymptotics of even-even correlations in the Ising model</i> . . . . .	214
Alain-Sol Sznitman	
<i>On macroscopic holes in some dependent percolation models</i> . . . . .	217

Lorenzo Taggi (joint with V. Betz)	
<i>Ensembles of self-avoiding polygons</i> .....	217
Antal A. Járai	
<i>Open problems about Abelian sandpiles</i> .....	226
Alexander Glazman (joint with Nick Crawford, Hugo Duminil-Copin, Ioan Manolescu, Ron Peled, and Yinon Spinka)	
<i>Phase transition in the loop <math>O(n)</math> model</i> .....	229
Omer Angel (joint with Alexander Holroyd, Thomas Hutchcroft, Avi Levy)	
<i>Mallows permutations: stable matchings and scaling</i> .....	230
Peter Gracar (joint with Alexandre Stauffer)	
<i>Spread of a rumor via a Lipschitz surface on percolation</i> .....	232
Amanda Turner (joint with Alan Sola, Fredrik Viklund)	
<i>Singular scaling limits in a planar random growth model</i> .....	235
Bálint Tóth	
<i>Quenched CLT for random walk in doubly stochastic random environment</i> .....	238
Nick Crawford (joint with Ron Rosenthal)	
<i>Eigenvector correlations in the complex Ginibre ensemble</i> .....	241
Andrea Collevecchio (joint with Kais Hamza, Yunxuan Liu, Meng Shi & Ruth Williams)	
<i>General Bootstrap Random Walks</i> .....	246

## Abstracts

### The branching-ruin number and the once-reinforced random walk

DANIEL KIOUS

(joint work with Andrea Collevecchio and Vladas Sidoravicius)

In a joint-work with Andrea Collevecchio and Vladas Sidoravicius [3], we study the phase transition for recurrence/transience of a fairly large class of self-interacting random walks on trees, which includes the once-reinforced random walk (ORRW). Our main tool is a quantity, that we call the *branching-ruin number* of a tree, which provides a natural way to measure trees with polynomial growth. In particular, we prove that the branching-ruin number of a tree is equal to the critical parameter for the recurrence/transience of ORRW on this tree, providing the complete picture of its phase transition. The last statement is a corollary of a more general study of a larger class of self-interacting random walks, for which we prove a sharp and effective (i.e. computable) criterion characterizing their recurrence or transience. This class of processes includes a generalization of the ORRW, as well as biased random walks, or random walks in random environment.

The study of self-interacting random walks is challenging, as they are not Markovian, and proving recurrence or transience is difficult. Our approach provides the first general technique for the study of ORRW.

The idea of the branching-ruin number stems both from the Hausdorff dimension of a tree defined by Furstenberg [9] and from the branching number introduced by Lyons [11] who linked it to biased random walks, percolation and Ising model on trees. In [12], Lyons and Peres write “*the branching number of a tree is a single number that captures enough of the complexity of a general tree to give the critical value for a stochastic process on the tree*”. The branching-ruin number aims at fulfilling the same mission, but for a different class of random walks and trees. The branching number is adapted to the study of trees with exponential growth. The branching-ruin number is designed for the study of trees with polynomial growth and is strikingly related to the critical parameter of the ORRW.

The ORRW was introduced in 1990 by Davis [6]. This model can be defined on any locally finite graph and corresponds to a self-interacting random walk which jumps through an edge with a probability proportional to its current weight. The current weight of an edge is initially set to 1, changed to some reinforcement parameter  $\delta > 0$  right after the first time this edge is crossed, and will never be modified again. Hence, the current weight of an edge is changed at most *once*. Despite its simple definition, the ORRW turns out to be difficult to analyze and, so far, no general tools were available for its study. Sidoravicius conjectured that on  $\mathbb{Z}^d$ ,  $d \geq 3$ , the ORRW undergoes a phase transition recurrence/transience with respect to the reinforcement parameter. This problem is still open on the hypercubic lattice. In the two-dimensional case, recurrence on  $\mathbb{Z}^2$  remains unsolved.

Durrett, Kesten and Limic [8] proved that this conjecture does not hold on the binary tree and that ORRW is transient for any choice of parameter. This was extended to supercritical Galton-Watson trees by Collecchio [2]. Besides, positivity and monotonicity of the speed on Galton-Watson trees was studied by Collecchio, Holmes and Kious [4]. Finally, some partial results on ladders were proved by Sellke [15] and Vervoort [16].

Recently, Kious and Sidoravicius [10] provided the first example of phase transition for ORRW on  $\mathbb{Z}^d$ -like trees. It should be noted that these trees were spherically symmetric with a particular structure, growing polynomially fast.

We should mention that a similar phase transition was conjectured for linearly edge-reinforced random walks (ERRW) on  $\mathbb{Z}^d$  in the eighties by Coppersmith and Diaconis [5], and was first proved on regular trees by Pemantle [13]. Only recently, the phase transition recurrence/transience on  $\mathbb{Z}^d$ ,  $d \geq 3$ , was established in a series of paper by Angel, Crawford and Kozma [1], Sabot and Tarrès [14], and Disertori, Sabot and Tarrès [7]. However, techniques developed for ERRW do not apply to ORRW, in particular because exchangeability does not hold.

Here, we treat the case of general trees. In particular, we recover and generalize any known result about ORRW by computing the branching-ruin number of the trees in these contexts. Besides, we state a sharp criterion which is stronger than existing results in the sense that it allows inhomogeneous initial weights and inhomogeneous reinforcement.

Finally, while recurrence is easily obtained via a first moment method, the main idea of our proof of transience relies on the presence of an infinite cluster for a particular correlated percolation.

#### REFERENCES

- [1] Angel, O., Crawford, N. and Kozma, G. (2014). Localization for linearly edge reinforced random walks. *Duke Math. J.* **163**(5), 889–921.
- [2] Collecchio, A. (2006). On the transience of processes defined on Galton-Watson trees. *Ann. Probab.* **34**(3), 870–878.
- [3] Collecchio, A., Kious, D. and Sidoravicius, V. (2017). The branching-ruin number and the critical parameter of once-reinforced random walk on trees. *preprint*, arXiv:1710.00567
- [4] Collecchio, A., Holmes, M. and Kious, D. (2017). On the speed of once-reinforced biased random walk on trees. *preprint*, arXiv:1702.01982.
- [5] Coppersmith, D. and Diaconis, P. (1986). Random walks with reinforcement. *Unpublished manuscript*.
- [6] Davis, B. (1990) Reinforced random walk, *Probability Theory and Related Fields* **84**, 203–229.
- [7] Disertori, M., Sabot, C. and Tarrès, P. (2015). Transience of edge-reinforced random walk. *Comm. Math. Phys.* **339**(1), 121–148.
- [8] Durrett, R. , Kesten, H., and Limic, V., (2002) Once edge-reinforced random walk on a tree”, *Probability Theory and Related Fields* **122**(4), 567–592.
- [9] Furstenberg, H. (1970) Intersections of Cantor sets and transversality of semigroups. In Gunning, R.C., editor, *Problems in Analysis*, pages 41–59. Princeton University Press, Princeton, NJ. A symposium in honor of Salomon Bochner, Princeton University, Princeton, NJ, 1–3 April 1969. MR: 50:7040
- [10] Kious, D. and Sidoravicius, V. (2016) Phase transition for the Once-reinforced random walk on  $\mathbb{Z}^d$ -like trees. *Ann. Probab.*, to appear. arXiv:1604.07631 [math.PR]



- [11] Lyons, R. (1990). Random walks and percolation on trees. *Ann. Probab.* **18(3)**, 931–958.
- [12] Lyons, R. and Peres Y. (2016). Probability on trees and networks. *Cambridge University Press, New York*. Pages xvi+699. Available at <http://pages.iu.edu/~rdlyons/>.
- [13] Pemantle, R. (1988). Phase transition in reinforced random walk and RWRE on trees. *Ann. Probab.* **16**, 1229–1241.
- [14] Sabot, C. and Tarrès, P. (2015). Edge-reinforced random walk, vertex-reinforced jump process and the supersymmetric hyperbolic sigma model. *J. Eur. Math. Soc.* **17(9)**, 2353–2378.
- [15] Sellke, T. (2006). Recurrence of reinforced random walk on a ladder. *Electron. J. Probab.* **11**, 301–310.
- [16] Vervoort, M. (2002). Reinforced random walks. *unpublished*.

## A condition for long-range order in discrete spin systems

YINON SPINKA

(joint work with Ron Peled)

We consider discrete spin systems on the lattice  $\mathbb{Z}^d$ . The configurations of the system are functions  $f$  from a bounded region  $\Lambda \subset \mathbb{Z}^d$  to some finite set of spins  $S$ . The spin system is described by a collection  $(\lambda_i)_{i \in S}$  of positive numbers, called the single-site activities, and a collection  $(\gamma_{i,j})_{i,j \in S}$  of non-negative numbers (not all of which are zero) with  $\gamma_{i,j} = \gamma_{j,i}$  for all  $i$  and  $j$ , called the pair interactions. Each configuration  $f$  has an associated weight given by

$$\omega_f := \prod_v \lambda_{f(v)} \prod_{u \sim v} \gamma_{f(u), f(v)},$$

where the first product is over sites  $v \in \Lambda$  and the second product is over nearest-neighbors  $u, v \in \Lambda$ . One then samples a random configuration according to these weights, i.e., the probability of choosing a particular  $f$  is proportional to  $\omega_f$ . One may obtain infinite-volume Gibbs measures in the usual manner, by taking limits as  $\Lambda$  increases to  $\mathbb{Z}^d$ , possibly placing suitable boundary conditions.

We show that for a large class of such spin systems, when the dimension  $d$  is sufficiently high, the random configuration exhibits a type of long-range order. The class of spin systems for which our results apply includes numerous well-known models, amongst which are: the anti-ferromagnetic Potts model (including proper colorings, its zero-temperature version), the hard-core model, the Widom-Rowlinson model and others. New results are obtained in many cases.

In order to formulate our results, we require some definitions. A *pattern* is a pair  $(A, B)$  of subsets of  $S$  such that

$$\gamma_{a,b} = \gamma_{\max} \text{ for all } a \in A \text{ and } b \in B, \quad \text{where } \gamma_{\max} := \max_{i,j \in S} \gamma_{i,j}.$$

The *weight* of a pattern  $(A, B)$  is  $\lambda_A \lambda_B$ , where  $\lambda_I := \sum_{i \in I} \lambda_i$  for  $I \subset S$ . Let  $\omega_{\max}$  denote the maximum weight of a pattern and call a pattern *dominant* if its weight is  $\omega_{\max}$ . We say that two patterns  $(A, B)$  and  $(A', B')$  are *equivalent* if there is a bijection  $\varphi: S \rightarrow S$  such that

$$\{\varphi(A), \varphi(B)\} = \{A', B'\}, \quad \lambda_{\varphi(i)} = \lambda_i, \quad \gamma_{\varphi(i), \varphi(j)} = \gamma_{i,j}, \quad i, j \in S.$$

We emphasize that if  $(A, B)$  is a dominant pattern with  $A \neq B$ , then  $(A, B)$  and  $(B, A)$  are two equivalent, albeit distinct, dominant patterns. Our results apply to discrete spin systems in which all dominant patterns are equivalent.

We also require a quantitative condition on the weights  $(\lambda_i)$  and  $(\gamma_{i,j})$ . Define the activity, interaction and pattern ratios,  $\rho_a, \rho_i$  and  $\rho_p := \max\{\rho_p^1, \rho_p^2\}$ , by

$$\begin{aligned} \rho_a &:= \frac{\min_i \lambda_i}{\max_i \lambda_i}, & \rho_p^1 &:= \max_{\substack{(A,B) \text{ non-dom} \\ \text{max pattern}}} \frac{\lambda_A \lambda_B}{w_{\max}}, \\ \rho_i &:= \max_{\substack{i,j \\ \gamma_{i,j} < \gamma_{\max}}} \frac{\gamma_{i,j}}{\gamma_{\max}}, & \rho_p^2 &:= \max_{\substack{(A,B) \text{ dom pattern} \\ (A',B') \text{ max pattern} \\ A' \subsetneq A}} \frac{\lambda_{A'}}{\lambda_A}, \end{aligned}$$

where a pattern  $(A, B)$  is maximal if no other pattern  $(A', B')$  satisfies  $A \subset A'$  and  $B \subset B'$ . Our condition is

$$(1) \quad \log \left[ \frac{1}{1 - (1 - \rho_p)(1 - \rho_i^{c_0/q})} \right] \geq \frac{C_0 q^3 \log^2 d + \log \frac{1}{\rho_a}}{d^{1/4}},$$

where  $C_0, c_0 > 0$  are universal constants. It is worth noting that any  $(\lambda_i)$  and  $(\gamma_{i,j})$  satisfy (1) in sufficiently high dimensions.

We say that a vertex of  $\mathbb{Z}^d$  is *even* or *odd* according to the parity of the sum of its coordinates. Given a configuration  $f$ , we say that a vertex  $v$  *follows the*  $(A, B)$ -*pattern* if either,  $v$  is even and  $f(v) \in A$ , or,  $v$  is odd and  $f(v) \in B$ . A set of vertices is an  $(A, B)$ -*cluster* if it is a maximal connected set of vertices following the  $(A, B)$ -pattern.

**Theorem 1.** *There exist  $C_0, c_0 > 0$  such that the following holds. Suppose  $d \geq 2$ , the spin system satisfies (1) and all dominant patterns are equivalent. Then for any dominant pattern  $(A, B)$ , the system exhibits an ordered state characterized by having, almost surely, a unique infinite  $(A, B)$ -cluster and having no infinite  $(A', B')$ -cluster for any other dominant pattern  $(A', B')$ . These states are extreme equilibrium states (i.e., maximum-pressure Gibbs measures), invariant to automorphisms preserving the two sublattices, and the system has no other extreme, periodic, equilibrium states.*

The theorem characterizes all the possible periodic orderings which arise in such a spin system. Namely, each dominant pattern gives rise to an ordering in which most sites follow this pattern, and every periodic ordering is obtained in this manner from some dominant pattern. In particular, the extreme periodic equilibrium states are in bijection with the dominant patterns, and hence there exist multiple Gibbs measures whenever  $(A, A)$  is not the unique dominant pattern.

The proof of Theorem 1 reveals that the global structure of the  $\mathbb{Z}^d$  lattice is not essential to the result. The proof adapts to other lattices of coordination number at least  $d$  and dimension at least 2 which have some of the local features of  $\mathbb{Z}^d$ , such as the lattice  $\mathbb{Z}^2 \times \{0, 1\}^{d-2}$  (in a sense, the ‘global dimension’ of this graph is 2 and its ‘local dimension’ is  $d$ ). A result with similar features on the hypercube graph  $\{0, 1\}^d$  was proved earlier by Engbers–Galvin [5].

A presentation of the above theorem and its proof which is geared towards a physics audience is available in [17]. Full details will appear in a forthcoming paper [18]. The proof technique is an elaborate form of the classical Peierls argument whose main ingredients are: (i) vertices are classified, by considering the values their neighbors take, into being in zero, one or more dominant patterns, (2) the probability of given interfaces separating regions associated with dominant patterns is estimated using an information-theoretic inequality of Shearer [2, 12, 11, 8] and (3) the possible interfaces are coarse-grained according to their rough shape. This uses the fact that the interfaces arising in the model respect the bipartite structure of the  $\mathbb{Z}^d$  lattice (so called “odd cutsets”) by having all their boundary vertices in the same bipartite class [19, 9, 15, 10, 6, 7].

Let us briefly describe the result in the context of some well-known models.

**AF Potts model.** The  $q$ -state AF Potts model at inverse temperature  $\beta > 0$  is obtained when

$$S = \{1, \dots, q\}, \quad \lambda_i = 1, \quad \gamma_{i,j} = \mathbf{1}_{\{i \neq j\}} + e^{-\beta} \mathbf{1}_{\{i=j\}},$$

where  $\mathbf{1}_E$  equals 1 when  $E$  holds and equals 0 otherwise. In this case, the dominant patterns are all equipartitions of  $[q] := \{1, \dots, q\}$  into two sets, i.e., pairs  $(A, B)$  of disjoint subsets of  $[q]$  such that  $A \cup B = [q]$  and  $|A|, |B| \geq \lfloor q/2 \rfloor$ . Theorem 1 shows that when  $q \leq c d^{1/20} \log^{-2/5} d$  and  $\beta \geq C q^6 d^{-1/4} \log^2 d$ , there are  $\binom{q}{\lfloor q/2 \rfloor}$  or  $2 \binom{q}{\lfloor q/2 \rfloor}$  extreme periodic equilibrium states according to whether  $q$  is even or odd. This (and much more) is well-known for  $q = 2$  (which corresponds to the Ising model). This was previously known also for  $q = 3$  and large  $\beta$ , with the  $\beta = \infty$  case (proper colorings) due, independently, to Peled [15] and to Galvin–Kahn–Randall–Sorkin [10], and the finite  $\beta$  case due to Feldheim–Spinka [6] who proved the Kotecký conjecture [13]. The result here is novel for  $q \geq 4$ . We remark that the Dobrushin uniqueness condition [3] implies that when  $q$  is large or  $\beta$  is small as a function of the dimension ( $q > 4d$  or  $\beta < c_q/d$  suffices), the model ceases to exhibit long-range order.

**Hard-core model.** The hard-core lattice-gas model at fugacity  $\lambda > 0$  is obtained when

$$S = \{0, 1\}, \quad \lambda_0 = 1, \lambda_1 = \lambda, \quad \gamma_{i,j} = \mathbf{1}_{\{ij \neq 1\}}.$$

The configurations here may be identified with independent sets. In this case, there are two dominant patterns,  $(\{0\}, \{0, 1\})$  and  $(\{0, 1\}, \{0\})$ , and Theorem 1 shows that when  $\lambda \geq C d^{-1/4} \log^2 d$ , there are two extreme periodic Gibbs states, one in which the independent set consists mostly of even vertices and one in which it consists mostly of odd vertices. The fact that this is the case for very large fugacity ( $\lambda > C^d$ ) goes back to Dobrushin [4]. The condition  $\lambda \geq C d^{-1/4} \log^{3/4} d$  was first proven by Galvin–Kahn [9]. Currently, the best known condition, due to Peled–Samotij [16], is  $\lambda \geq C d^{-1/3} \log^2 d$ . As in the case of the AF Potts model, Dobrushin’s uniqueness condition implies that when  $\lambda$  is sufficiently small as a function of the dimension ( $\lambda \leq 1/2d$  suffices), the model ceases to exhibit long-range order.

**Widom-Rowlinson model.** The lattice *Widom-Rowlinson model* at activity  $\lambda$  is given by

$$S = \{-1, 0, 1\}, \quad \lambda_i = \lambda^{|i|}, \quad \gamma_{i,j} = \mathbf{1}_{\{ij \neq -1\}}.$$

The dominant patterns are  $(\{0, 1\}, \{0, 1\})$  and  $(\{0, -1\}, \{0, -1\})$ , and Theorem 1 shows that when  $\lambda \geq Cd^{-1/8} \log d$ , there are two extreme periodic Gibbs states, characterized by an unequal density of  $\pm 1$ . This was previously known only for very large fugacity ( $\lambda \geq C^d$ ) [14, 1]. In particular, we obtain the first proof that the critical fugacity tends to 0 with the dimension.

**Clock model.** The  $\mathbb{Z}_q$ -clock model with ‘hammock’ potential of width  $m$  is obtained when

$$S = \mathbb{Z}_q = \mathbb{Z}/q\mathbb{Z}, \quad \lambda_i = 1, \quad \gamma_{i,j} = \mathbf{1}_{\{\text{dist}_{\mathbb{Z}_q}(i,j) \leq m\}}.$$

When  $m < \frac{q}{4}$ , the dominant patterns are  $(i + A, i + A)$ ,  $i \in S$ ,  $A := \{0, 1, \dots, m\}$ . Theorem 1 then shows that when  $m^2 q^3 \leq cd^{1/4} \log^{-2} d$ , each extremal maximal-entropy Gibbs measure is characterized by an interval of size  $m + 1$  in which most spins take values. This was previously known only when  $m = 1$  [15].

## REFERENCES

- [1] Robert Burton and Jeffrey Steif, *New results on measures of maximal entropy*, Israel Journal of Mathematics **89** (1995), no. 1, 275–300.
- [2] Fan Chung, Ronald Graham, Peter Frankl and James Shearer, *Some intersection theorems for ordered sets and graphs*, Journal of Combinatorial Theory, Series A **43** (1986), no. 1, 23–37.
- [3] Roland L. Dobrushin, *Description of a random field by means of conditional probabilities and conditions for its regularity* (Russian), Teor. Veroyatnost. i Primenen **13** (1968) 201–229.
- [4] Roland L. Dobrushin, *The problem of uniqueness of a Gibbsian random field and the problem of phase transitions*, Functional analysis and its applications **2** (1968), no. 4, 302–312.
- [5] John Engbers and David Galvin, *H-coloring tori*, Journal of Combinatorial Theory, Series B **102** (2012), no. 5, 1110–1133.
- [6] Ohad Feldheim and Yinon Spinka, *Long-range order in the 3-state antiferromagnetic Potts model in high dimensions*, arXiv preprint arXiv:1511.07877, to appear in Journal of the European Mathematical Society.
- [7] Ohad Feldheim and Yinon Spinka, *The growth constant of odd cutsets in high dimensions*, Combinatorics, Probability and Computing (2017), 1–20
- [8] David Galvin, *Bounding the partition function of spin-systems*, Journal of Combinatorics **13**, no. 3, 72
- [9] David Galvin and Jeff Kahn, *On phase transition in the hard-core model on  $\mathbf{Z}^d$* , Combinatorics, Probability and Computing **13** (2004), no. 2, 137–164.
- [10] David Galvin, Jeff Kahn, Dana Randall, and Gregory Sorkin, *Phase coexistence and torpid mixing in the 3-coloring model on  $\mathbf{Z}^d$* , SIAM J. Discrete Math. **29** (2015), no. 3, 1223–1244.
- [11] David Galvin and Prasad Tetali, *On weighted graph homomorphisms*, DIMACS Series in Discrete Mathematics and Theoretical Computer Science **63** (2004), 97–104.
- [12] Jeff Kahn, *An entropy approach to the hard-core model on bipartite graphs*, Combinatorics, Probability and Computing **10** (2001), no. 03, 219–237.
- [13] Roman Kotecký, *Long-range order for antiferromagnetic Potts models*, Physical Review B **31** (1985), no. 5, 3088–3092.
- [14] Joel L. Lebowitz and Giovanni Gallavotti, *Phase transitions in binary lattice gases*, Journal of Mathematical Physics **12** (1971), no. 7, 1129–1133.

- [15] Ron Peled, *High-dimensional Lipschitz functions are typically flat*, The Annals of Probability **45** (2017), no. 3, 1351–1447.
- [16] Ron Peled and Wojciech Samotij, *Odd cutsets and the hard-core model on  $\mathbb{Z}^d$* , Annales de l'Institut Henri Poincaré, Probabilités et Statistiques **50** (2014), no. 3, 975–998.
- [17] Ron Peled and Yinon Spinka, *A condition for long-range order in discrete spin systems with application to the antiferromagnetic Potts model*, arXiv preprint arXiv:1712.03699 (2017)
- [18] Ron Peled and Yinon Spinka, In preparation.
- [19] Alexander Sapozhenko, *On the number of connected subsets with given cardinality of the boundary in bipartite graphs*, Metody Diskretnogo Analiza (Russian) **45** (1987)

## First passage percolation in hostile environment (on hyperbolic graphs)

ELISABETTA CANDELLERO

(joint work with Alexandre Stauffer)

We consider two types of first passage percolation (FPP) processes evolving on a bounded-degree graph  $G = (V(G), E(G))$ . We will distinguish the two processes by considering *black* and *red* particles.

Start by choosing a reference vertex  $o \in V(G)$  and placing there a *black* particle. Subsequently, fix a parameter  $\mu \in (0, 1)$  and for all vertices  $x \in V(G) \setminus \{o\}$  place a *red* particle at  $x$  with probability  $\mu$  and no particle with probability  $1 - \mu$ .

After this procedure, the black particle at  $o$  gives rise to a FPP process having passage times exponentially distributed with parameter 1. We call this process  $F_1$ ; in the meanwhile, red particles are left inactive. For all times  $T > 0$  a FPP *cluster* consists of all vertices that are, in the induced FPP random metric, within distance  $T$  from the vertex where FPP originated. Inductively, whenever a red particle is at a vertex that is about to become part of an existing FPP cluster, such particle is *activated*, giving rise to a FPP process having passage times exponentially distributed with parameter  $\lambda > 0$ . Each FPP process started at a red particle follows the same law and is denoted by  $F_\lambda$ . Note that whenever a vertex is part of either the  $F_1$  or a  $F_\lambda$  cluster, it will remain so forever.

We are interested in the long-time behavior of the process. More precisely, when can we observe that there is an infinite  $F_1$  cluster? What about an infinite (connected)  $F_\lambda$  cluster? Is it possible that the two processes *coexist*, i.e., can there be an infinite  $F_1$  cluster and an infinite (connected)  $F_\lambda$  cluster at the same time?

This model was originally introduced in [2] with the name of *First passage percolation in hostile environment* (FPPHE). This was an auxiliary tool to investigate the long-time behavior of MDLA (Multi-particle Diffusion Limited Aggregation), known to be an extremely complicated and challenging model to analyze. In [2], the authors show that on  $\mathbb{Z}^d$  ( $d \geq 2$ ) whenever  $\lambda \in (0, 1)$  if the initial density  $\mu$  is small enough, then with positive probability there will be an infinite  $F_1$  cluster, but all  $F_\lambda$  clusters will be finite. They also conjecture that whenever  $\lambda \in (0, 1)$  it is possible to find a range of values for  $\mu$  that would guarantee coexistence, but this is still an open problem.

In [1], we analyze this model on non-amenable and hyperbolic graphs, showing that in this setting the asymptotic behavior of the process is fundamentally different from the one on  $\mathbb{Z}^d$ . More precisely, we show that for all values  $\lambda > 0$ , whenever the density  $\mu$  is small enough, with positive probability  $F_1$  and  $F_\lambda$  will coexist forever.

#### REFERENCES

- [1] E. Candellero, A. Stauffer, *Coexistence of first passage percolation in hostile environment on hyperbolic graphs*, In progress.
- [2] V. Sidoravicius, A. Stauffer, *Multi-particle diffusion limited aggregation*, Submitted.

### On the infection time of kinetically constrained models: universality in two dimensions

FABIO MARTINELLI

(joint work with Rob Morris and Cristina Toninelli)

Kinetically constrained models (KCM) are interacting particle systems on the integer lattice  $\mathbb{Z}^d$ , which were introduced in the 80s in order to model the liquid-glass transition, a major open problem in condensed matter physics. KCM feature some of the main signatures of a super-cooled liquid near the glass transition point: anomalously long mixing times [3, 8, 16], aging and dynamical heterogeneities [12], and ergodicity breaking transitions corresponding to percolation of blocked structures [13]. A generic KCM is a continuous time Markov process of Glauber type defined as follows. A configuration  $\omega$  is defined by assigning to each site  $x \in \mathbb{Z}^d$  an occupation variable  $\omega_x \in \{0, 1\}$ , corresponding to an empty or occupied site respectively. Each site waits an independent, mean one, exponential time and then, iff a certain local constraint is satisfied by the current configuration  $\omega$ , its occupation variable is updated to be occupied with rate  $p$  and to empty with rate  $q = 1 - p$ . All the constraints that have been considered in the physics literature belong to the following general class [8]. Fix an *update family*  $\mathcal{U} = \{X_1, \dots, X_m\}$ , that is, a finite collection of finite subsets of  $\mathbb{Z}^d \setminus \{\mathbf{0}\}$ . Then  $\omega$  satisfies the constraint at site  $x$  if there exists  $X \in \mathcal{U}$  such that  $\omega_y = 0$  for all  $y \in X + x$ . As a consequence, the product Bernoulli( $p$ ) measure  $\mu$  is a reversible invariant measure.

KCM can be also viewed as a natural non-monotone and stochastic counterpart of  $\mathcal{U}$ -bootstrap percolation, a well known class of discrete cellular automata [7]. For  $\mathcal{U}$ -bootstrap on  $\mathbb{Z}^d$ , given a configuration of “infected” sites  $A_t$  at time  $t$ , infected sites remain infected, and a site  $v$  becomes infected at time  $t + 1$  if the translate by  $v$  of one of the sets in  $\mathcal{U}$  belongs to  $A_t$ . One then defines the final infection set  $[A]_{\mathcal{U}} := \bigcup_{t=1}^{\infty} A_t$  and the *critical probability* of the  $\mathcal{U}$ -bootstrap process on  $\mathbb{Z}^d$  to be

$$(1) \quad q_c(\mathbb{Z}^d, \mathcal{U}) := \inf \left\{ q : \mathbb{P}_q([A]_{\mathcal{U}} = \mathbb{Z}^d) = 1 \right\},$$

where  $\mathbb{P}_q$  denotes the product probability measure on  $\mathbb{Z}^d$  with density  $q$  of infected sites. It was proved in [8] that the *relaxation time*  $T_{\text{rel}}(q; \mathcal{U})$  and the *mean infection time*  $\mathbb{E}_\mu(\tau_0)$  are finite for  $q > q_c(\mathbb{Z}^d, \mathcal{U})$  and infinite for  $q < q_c(\mathbb{Z}^d, \mathcal{U})$ .

**Question.** *Is it possible to group all possible update families  $\mathcal{U}$  into distinct classes, in such a way that all members of the same class induce the same divergence of the mean infection time as  $q$  approaches from above the critical value  $q_c(\mathbb{Z}^d, \mathcal{U})$ ?*

The universality question stated above has been addressed and successfully solved for two-dimensional  $\mathcal{U}$ -bootstrap percolation (see [7, 5, 6], or [17] for a recent review). The update families  $\mathcal{U}$  were classified in [7] into three universality classes: *supercritical*, *critical* and *subcritical*, according to a simple geometric criterion. Then it was proved in [7] that  $q_c(\mathbb{Z}^2, \mathcal{U}) = 0$  if  $\mathcal{U}$  is supercritical or critical, and that  $q_c(\mathbb{Z}^2, \mathcal{U}) > 0$  if  $\mathcal{U}$  is subcritical [5]. For critical update families  $\mathcal{U}$ , the scaling (as  $q \downarrow 0$ ) of the typical infection time of the origin starting from  $\mathbb{P}_q$  was determined very precisely in [6].

In this talk we will report paper on a first important step towards establishing a similar universality picture for two-dimensional KCM with supercritical or critical update family  $\mathcal{U}$ . Using a geometric criterion, we classify a supercritical update family  $\mathcal{U}$  as being *supercritical unrooted* or *supercritical rooted* and a critical  $\mathcal{U}$  as being  $\alpha$ -*rooted* or  $\beta$ -*unrooted*, where  $\alpha \in \mathbb{N}$  and  $\alpha \leq \beta \in \mathbb{N} \cup \{\infty\}$  are called the *difficulty* and the *bilateral difficulty* of  $\mathcal{U}$  respectively (see [15]). We then prove the following two main universality results.

**Supercritical KCM.** *Let  $\mathcal{U}$  be a supercritical two-dimensional update family. Then, as  $q \rightarrow 0$ ,*

(a) *if  $\mathcal{U}$  is unrooted*

$$\mathbb{E}_\mu(\tau_0) \leq q^{-O(1)};$$

(b) *if  $\mathcal{U}$  is rooted,*

$$\mathbb{E}_\mu(\tau_0) \leq \exp\left(O(\log q^{-1})^2\right).$$

**Critical KCM.** *Let  $\mathcal{U}$  be a critical two-dimensional update family with difficulty  $\alpha$  and bilateral difficulty  $\beta$ . Then, as  $q \rightarrow 0$ ,*

(a) *if  $\mathcal{U}$  is  $\alpha$ -rooted*

$$\mathbb{E}_\mu(\tau_0) \leq \exp\left(q^{-2\alpha} (\log q^{-1})^{O(1)}\right);$$

(b) *if  $\mathcal{U}$  is  $\beta$ -unrooted*

$$\mathbb{E}_\mu(\tau_0) \leq \exp\left(q^{-\beta} (\log q^{-1})^{O(1)}\right).$$

Even though the theorems above only establish universal *upper bounds* on  $\mathbb{E}_\mu(\tau_0)$ , we conjecture that our bounds provide the correct scaling up to logarithmic corrections. This has recently been proved for supercritical models in [15]. For critical update families, the bound  $\mathbb{E}_\mu(\tau_0) = \Omega(T_{\mathcal{U}})$  (see Lemma 4.3 in [16]),

where  $T_{\mathcal{U}}$  denotes the median infection time of the origin for the  $\mathcal{U}$ -bootstrap process, together with the results of [6] on  $T_{\mathcal{U}}$ , provide a matching lower bound for all  $\beta$ -unrooted models with  $\alpha = \beta$ . In particular, these recent advances combined with the above theorems prove two conjectures that we put forward in [17]. Among the  $\alpha$ -rooted models, those which have been considered most extensively in the literature are the Duarte and modified Duarte model (see [1, 2, 11]), for which  $\alpha = 1$  and  $\beta = \infty$ . In [15] a lower bound on  $\mathbb{E}_{\mu}(\tau_0)$  was recently obtained for both models that matches our upper bound, including the logarithmic corrections, yielding  $\mathbb{E}_{\mu}(\tau_0) = \exp(\Theta(q^{-2}(\log 1/q)^4))$ .

#### REFERENCES

- [1] Simulation of a cellular automaton with an oriented bootstrap rule. *Physica A. Statistical Mechanics and its Applications*, 157(3):1075–1079, 1989.
- [2] Critical length for semi-oriented bootstrap percolation. *Stochastic Processes and their Applications*, 56(2):185–205, 1995.
- [3] D. Aldous and P. Diaconis. The asymmetric one-dimensional constrained Ising model: rigorous results. *J. Stat. Phys.*, 107(5-6):945–975, 2002.
- [4] Hans C. Andersen and Glenn H. Fredrickson. Kinetic Ising Model of the Glass Transition. *Phys. Rev. Lett.*, 53(13):1244–1247, 1984.
- [5] P. Balister, B. Bollobas, Przykucki M.J., and P. Smith. Subcritical U–bootstrap percolation models have non–trivial phase transitions. *Trans.Amer.Math.Soc.*, 368:7385–7411, 2016.
- [6] B. Bollobás, H. Duminil-Copin, R. Morris, and P. Smith. Universality of two-dimensional critical cellular automata. *to appear in Proc. London Math. Soc.*, 2016.
- [7] B. Bollobas, P. Smith, and A. Uzzell. Monotone cellular automata in a random environment. *Combin.Probab.Comput.*, 24(4):687–722, 2015.
- [8] N. Cancrini, F. Martinelli, C. Roberto, and C. Toninelli. Kinetically constrained spin models. *Probab. Theory Rel.*, 140(3-4):459–504, 2008.
- [9] Paul Chleboun, Alessandra Faggionato, and Fabio Martinelli. Time scale separation and dynamic heterogeneity in the low temperature East model. *Commun. Math. Phys.*, 328:955–993, 2014.
- [10] Paul Chleboun, Alessandra Faggionato, and Fabio Martinelli. Mixing time and local exponential ergodicity of the East-like process in  $\mathbb{Z}^d$ . *Annales de la Faculté des Sciences de Toulouse : Mathématiques, Series 6*, 24(4):717–743, 2015.
- [11] Hugo Duminil-Copin, Robert Morris, and Paul Smith. The sharp threshold for the Duarte model. 2016.
- [12] A. Faggionato, F. Martinelli, C. Roberto, and C. Toninelli. Aging through hierarchical coalescence in the East model. *Commun. Math. Phys.*, 309:459–495, 2012.
- [13] J.P. Garrahan, P. Sollich, and C. Toninelli. Kinetically constrained models. in "Dynamical heterogeneities in glasses, colloids, and granular media", Oxford Univ. Press, Eds.: L. Berthier, G. Biroli, J-P Bouchaud, L. Cipelletti and W. van Saarloos. Preprint *arXiv:1009.6113*, 2011.
- [14] J. Jäckle and S. Eisinger. A hierarchically constrained kinetic Ising model. *Z. Phys. B: Condens. Matter*, 84(1):115–124, 1991.
- [15] Laure Maréché, Fabio Martinelli, and Cristina Toninelli. Energy barriers and the infection time for the kinetically constrained Duarte model. in preparation.
- [16] Fabio Martinelli and Cristina Toninelli. Towards a universality picture for the relaxation to equilibrium of kinetically constrained models. 2016.
- [17] Robert Morris. Bootstrap percolation, and other automata . *European Journal of Combinatorics*, to appear.
- [18] N S Pillai and Smith. A. Mixing times for a constrained Ising process on the torus at low density. *The Annals of Probability*, 45(2):1003–1070, 2017.



- [19] F. Ritort and P. Sollich. Glassy dynamics of kinetically constrained models. *Advances in Physics*, 52(4):219–342, 2003.
- [20] R. Schonmann. On the behaviour of some cellular automata related to bootstrap percolation. *Ann. Prob.*, 20:174–193, 1992.
- [21] A.C.D van Enter. Proof of Straley’s argument for bootstrap percolation. *J. Stat. Phys.*, 48:943–945, 1987.

### Self-Avoiding Walk on $T \times \mathbb{Z}$

THOMAS HUTCHCROFT

We show that Self-Avoiding Walk (SAW) on the product  $T \times \mathbb{Z}$  of a  $k$ -regular tree with the integers has mean-field behaviour when  $k \geq 3$ . This means that the number  $Z_n$  of SAWs of length  $n$  grows exactly exponentially

$$Z_n \asymp \mu_c^n$$

for some  $\mu_c$ , with no subexponential correction. The proof applies more generally to any graph such that the automorphism group  $\text{Aut}(G)$  has a transitive nonunimodular subgroup, e.g.  $T \times H$  for arbitrary transitive  $H$ .

### A toy model for uphill diffusion

DMITRY IOFFE

Uphill diffusion is an umbrella name for a non-equilibrium phenomena when, in the absence of exterior forces, the current goes from a low density reservoir to the high density one. I am grateful to Anna De Masi and Errico Presutti for an introduction to this area, and I refer to the very recent [1, 2, 3, 4] for an extensive discussion, examples, simulations and few rigorous results. In the talk I shall focus on a particularly simple example - two Curie-Weiss systems below critical temperature, which are in contact with infinite reservoirs.

Consider two mean-field systems A and B of sizes  $N \in \mathbb{N}$  each. The spin variables are  $\sigma_A, \sigma_B \in \{\pm 1\}^N$  and For  $\sigma \in \{\pm 1\}^N$  define the average magnetization  $m_N = m_N(\sigma)$  and the Hamiltonian  $\mathcal{H}_N = \mathcal{H}_N(\sigma)$  via

$$(1) \quad m_N(\sigma) = \frac{1}{N} \sum_{i=1}^N \sigma(i) \quad \text{and} \quad \mathcal{H}_N(\sigma) = -\frac{N}{2} (m_N(\sigma))^2.$$

For  $\sigma \in \{\pm 1\}^N$  define flips:

$$(2) \quad \sigma^i(j) = \begin{cases} -\sigma(i), & \text{if } j = i \\ \sigma(j), & \text{if } j \neq i. \end{cases}$$

Fix  $r \in (0, 1)$ . We assume that the system B is in a contact with an *infinite* reservoir  $R^+$  of mean magnetization  $r$ , and that the system A is in a contact with an *infinite* reservoir  $R^-$  of mean magnetization  $-r$ . For the given value  $\beta$  of inverse temperature define flip rates as follows:

1. Exchanges between A and B systems: For  $i, j \in \{1, \dots, N\}$  the flip  $(\sigma_A, \sigma_B) \mapsto (\sigma_A^i, \sigma_B)^j$  occurs with rate

$$(3) \quad \begin{aligned} & \frac{1}{N} e^{-2\beta/N} e^{-\frac{\beta}{2}(\mathcal{H}_N(\sigma_A^i) + \mathcal{H}_N(\sigma_B^j) - \mathcal{H}_N(\sigma_A) - \mathcal{H}_N(\sigma_B))} \mathbf{1}_{\{\sigma_A(i)\sigma_B(j) = -1\}} \\ & = \frac{1}{N} e^{-\beta(\sigma_A(i)m_N(\sigma_A) + \sigma_B(j)m_N(\sigma_B))} \mathbf{1}_{\{\sigma_A(i)\sigma_B(j) = -1\}}. \end{aligned}$$

2. Exchanges with infinite reservoirs: Flips  $(\sigma_A, \sigma_B) \mapsto (\sigma_A^i, \sigma_B)$  and  $(\sigma_A, \sigma_B) \mapsto (\sigma_A, \sigma_B^j)$  occur with rates

$$(4) \quad \frac{1 + \sigma_A(i)r}{2} \quad \text{and} \quad \frac{1 - \sigma_B(j)r}{2},$$

respectively.

The induced two-dimensional mean-field dynamics of  $(m_N(\sigma_A(t)), m_N(\sigma_B(t)))$  is Markovian and ergodic. Let  $\nu_N^\beta$  is its invariant measure. The phenomenon of the uphill diffusion could be described as follows: Let  $\beta > \beta_c^{\text{CW}} = 1$ , and assume that  $r \in (0, m_\beta^{\text{CW}})$ , where  $m_\beta^{\text{CW}}$  is the Curie-Weiss spontaneous magnetization. Then there exists  $\Delta \in (r, m_\beta^{\text{CW}})$  such that  $\nu_N$  is, as  $N \rightarrow \infty$ , concentrated around  $(-\Delta, \Delta)$ . That is, for any  $\epsilon > 0$ ,

$$\lim_{N \rightarrow \infty} \nu_N (|m(\sigma_A) + \Delta| + |m(\sigma_B) - \Delta|) = 0.$$

In particular, there is a (limiting) current  $j = \frac{\Delta - r}{2} > 0$  from  $\mathbb{R}^-$  to  $\mathbb{R}^+$ .

#### REFERENCES

- [1] Matteo Colangeli, Anna De Masi, Errico Presutti, *Particle models with self sustained current*, Journal of Statistical Physics **167**, 5 (2017), 1081–1111, <https://arxiv.org/abs/1606.04920>
- [2] Matteo Colangeli, Anna De Masi, Errico Presutti *Microscopic models for uphill diffusion*, preprint <https://arxiv.org/abs/1705.01825>.
- [3] Emilio N.M. Cirillo, Matteo Colangeli, *Stationary uphill currents in locally perturbed Zero Range Processes*, preprint, <https://arxiv.org/abs/1709.03712>
- [4] Matteo Colangeli, Cristian Giardin, Claudio Giberti, Cecilia Vernia, *Non-equilibrium 2D Ising model with stationary uphill diffusion*, preprint, <https://arxiv.org/abs/1708.00751>.

### Cutoff at the “entropic time” for sparse Markov chains

PIETRO CAPUTO

(joint work with Charles Bordenave and Justin Salez)

We consider the problem of estimating the time to reach equilibrium for a large class of Markov chains in random environment. The chains are sparse in the sense that in every row of the transition matrix  $P$  the mass is essentially concentrated on few entries. Moreover, within each row the entries of  $P$  are exchangeable random variables, and the rows are assumed to be independent. The associated Markov chains are generally non reversible and the equilibrium distribution  $\pi$  is itself unknown.

The model can be described as follows. Let  $(q_{i,j})_{1 \leq i,j \leq n}$  denote a deterministic  $n \times n$  stochastic matrix, and let  $(\sigma_i)_{1 \leq i \leq n}$  denote independent, uniform random permutations of  $\{1, \dots, n\}$ . Consider the random stochastic matrix:

$$P(i, j) := q_{i, \sigma_i^{-1}(j)}, \quad 1 \leq i, j \leq n.$$

Under mild *sparsity* and *non-degeneracy* assumptions on the matrix  $(q_{i,j})$  we find that with high probability the Markov chain associated to  $P$  has a unique invariant measure  $\pi$  and the convergence to the equilibrium displays the *cutoff phenomenon* at the “entropic time”

$$T_{\text{ENT}} = \frac{\log n}{H}, \quad H = -\frac{1}{n} \sum_{i,j=1}^n q_{i,j} \log q_{i,j}$$

This includes various models of random walk on random directed graphs. For instance, an example is the random walk on the  $d$ -out regular random digraph, for some integer  $d \geq 2$ . This corresponds to having exactly  $d$  elements equal to  $1/d$  in each row of the matrix  $P$ , that is for all  $i$ :  $q_{i,1} = \dots = q_{i,d} = 1/d$ , and  $q_{i,d+1} = \dots = q_{i,n} = 0$ . Other interesting examples are obtained by letting the input matrix  $q$  be sampled from some sparse, non-degenerate distribution. For instance, an important example concerns the case where the rows of  $P$  are i.i.d. random vectors in the domain of attraction of a Poisson-Dirichlet law:  $q_{i,j} = \omega(i, j) / \sum_{\ell} \omega(i, \ell)$ , where  $\omega(i, j)$ ,  $1 \leq i, j \leq n$ , are a realization of i.i.d. nonnegative random variables with regularly varying tail of index  $\alpha \in (0, 1)$ . We refer to [1, 2] for more details.

## REFERENCES

- [1] C. Bordenave, P. Caputo, J. Salez, *Random walk on sparse random digraphs*, Probability Theory and Related Fields 2017 (to appear).
- [2] C. Bordenave, P. Caputo, J. Salez, *Cutoff at the “entropic time” for sparse Markov chains*, Probability Theory and Related Fields 2018 (to appear).

## The scaling limit of the membrane model

ALESSANDRA CIPRIANI

(joint work with Biltu Dan and Rajat Subhra Hazra)

The main object of study in this work is the membrane model (MM), also known as discrete bilaplacian model. The membrane model is a special instance of a more general class of interface models in which the interaction of the system is governed by the exponential of an Hamiltonian function  $H : \mathbb{R}^{\mathbb{Z}^d} \rightarrow [0, \infty)$ . More specifically, random interfaces are fields  $\varphi = (\varphi_x)_{x \in \mathbb{Z}^d}$ , whose distribution is determined by the probability measure on  $\mathbb{R}^{\mathbb{Z}^d}$ ,  $d \geq 1$ , with density

$$\mathbf{P}_N(d\varphi) := \frac{e^{-H(\varphi)}}{Z_N} \prod_{x \in V_N} d\varphi_x \prod_{x \in \mathbb{Z}^d \setminus V_N} \delta_0(d\varphi_x),$$

where  $V_N := [-N, N]^d \cap \mathbb{Z}^d$ ,  $d\varphi_x$  is the 1-dimensional Lebesgue measure on  $\mathbb{R}$ ,  $\delta_0$  is the Dirac measure at 0, and  $Z_N$  is a normalising constant. We are imposing zero boundary conditions, but the definition holds for more general boundary conditions. A relevant example is where the Hamiltonian is driven by a convex function of the gradient, that is,  $H(\varphi) = \sum_{x \sim y} V(\varphi_y - \varphi_x)$ ,  $V : \mathbb{R} \rightarrow \mathbb{R}$  convex, and the sum being over nearest neighbours. The most well-known among these interfaces is the discrete Gaussian free field (DGFF) when  $V(x) \propto x^2/2$ .

The membrane model is the Gaussian interface for which

$$(1) \quad H(\varphi) := \frac{1}{2} \sum_{x \in \mathbb{Z}^d} |\Delta_1 \varphi_x|^2 = \frac{1}{2} \langle \varphi, \Delta_1^2 \varphi \rangle_{\ell^2(\mathbb{Z}^d)}$$

and  $\Delta_1$  is the discrete Laplacian defined by

$$\Delta_1 f(x) = \frac{1}{2d} \sum_{y \sim x} (f(y) - f(x)), \quad f : \mathbb{Z}^d \rightarrow \mathbb{R}, \quad x \in \mathbb{Z}^d.$$

Introduced by [Sakagawa(2003)] in the probabilistic literature, the MM looks for certain aspects very similar to the DGFF: it is log-correlated in  $d = 4$ , has a supercritical regime in  $d \geq 5$  and is subcritical in  $d \leq 3$ . In particular in  $d = 2, 3, 4$  there is no thermodynamic limit of the measures  $\mathbf{P}_N$  as  $N \uparrow \infty$ . We present our work which aims at determining the scaling limit of the bilaplacian model. The answer in  $d = 1$  was given by [Caravenna and Deuschel(2009), Hryniv and Velenik(2009)] using an integrated random walk representation. We can summarize our results as follows.

- In  $d = 2, 3$  we consider the discrete membrane model on a box of side-length  $2N$  and interpolate it in a continuous way. We show that the process converges in the space of continuous functions to a Hölder-continuous Gaussian process. This also yields the scaling limit of the discrete maximum exploiting the continuous mapping theorem. While the limiting maximum of the MM was derived by [Chiarini et al.(2016)] in  $d \geq 5$ , in  $d = 4$  the problem remains open as far as the authors know (tightness can be derived from [Ding et al.(2017)]).

The proof of the above facts is based on two basic steps: tightness and finite dimensional convergence. Tightness depends on the gradient estimates of the discrete Green's functions which were very recently derived in [Müller and Schweiger(2017)]; finite dimensional convergence follows from the convergence of the Green's function.

- In  $d = 4$  the limiting process on a sufficiently nice domain  $D$  will be a fractional Gaussian field with Hurst parameter  $H := 0$ , represented via a Wiener series in terms of the eigenvalues of the biharmonic operator in the continuum.

The proof is again split into two steps: finite dimensional convergence and tightness. Both steps crucially require an approximation result of PDEs given by [Thomée(1964)]: there he gives quantitative estimates on

the approximation of solutions of PDEs involving “nice” elliptic operators by their discrete counterparts.

- In  $d \geq 5$  we consider the infinite volume membrane model on  $\mathbb{Z}^d$ . We show that the limit is the fractional Gaussian field of Hurst parameter  $H := 2 - d/2 < 0$  on  $\mathbb{R}^d$  proving convergence with the help of characteristic functionals. Technical tools useful for this scope are the explicit Fourier transform of the infinite volume Green’s function and the Poisson summation formula.

## REFERENCES

- [Thomé(1964)] V. Thomée. Elliptic difference operators and dirichlet’s problem. *Contributions to Differential Equations*, 3(3), 1964.
- [Sakagawa(2003)] H. Sakagawa. Entropic repulsion for a Gaussian lattice field with certain finite range interactions. *J. Math. Phys.*, 44(7): 2939–2951, 2003.
- [Caravenna and Deuschel(2009)] F. Caravenna and J.-D. Deuschel. Scaling limits of (1+1)-dimensional pinning models with laplacian interaction. *Ann. Probab.*, 37(3):903–945, 05 2009.
- [Hryniv and Velenik(2009)] O. Hryniv and Y. Velenik. Some rigorous results on semiflexible polymers. I. Free and confined polymers. *Stochastic Process. Appl.*, 119(10):3081–3100, 2009.
- [Ding et al.(2017)] J. Ding, R. Roy, and O. Zeitouni. Convergence of the centered maximum of log-correlated gaussian fields. *Ann. Probab.*, 45(6A):3886–3928, 11 2017.
- [Chiarini et al.(2016)] A. Chiarini, A. Cipriani, and R. S. Hazra. Extremes of some gaussian random interfaces. *Journal of Statistical Physics*, 165(3):521–544, Nov 2016. ISSN 1572-9613.
- [Müller and Schweiger(2017)] S. Müller and F. Schweiger. Estimates for the Green’s function of the discrete bilaplacian in dimensions 2 and 3. *ArXiv e-prints*, Dec. 2017.

**No exceptional word in Bernoulli percolation**

VINCENT TASSION

(joint work with Pierre Nolin and Augusto Teixeira)

Consider Bernoulli percolation on the sites of  $\mathbb{Z}^d$ ,  $d \geq 3$ .

$$(w(x))_{x \in \mathbb{Z}^d} \text{ iid, } w(x) = \begin{cases} 0 & \text{with probability } \frac{1}{2}, \\ 1 & \text{with probability } \frac{1}{2}. \end{cases}$$

We prove that a.s. every word (arbitrary infinite sequence of 0 and 1) can be read somewhere in the graph.

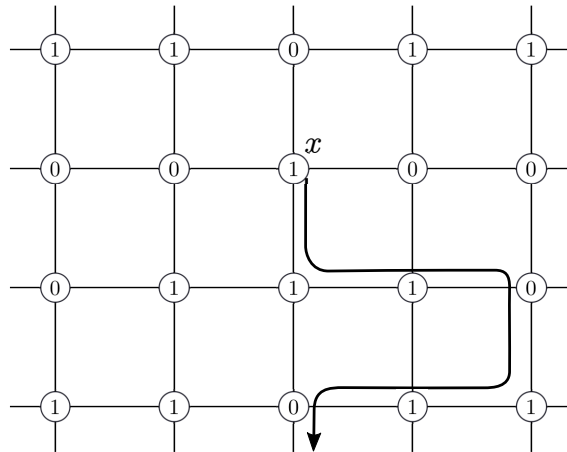

FIGURE 1. The word 1110110... is read from  $x$ .

### The free Ising state on the tree: continual decomposition into extremals

SENYA SHLOSMAN

I consider the Ising model on the Cayley tree and I investigate the decomposition of the free state into extreme states below the spin glass temperature. The number of the extremal Gibbs distributions that appear in that decomposition equals to  $\aleph_1$ , i.e. continuum. This exposition follows the manuscript by Daniel Gandolfo, Christian Maes, Jean Ruiz, Senya Shlosman: Glassy states: the free Ising model on a tree, arXiv:1709.00543.

Let  $\tau_k = (V, E)$  be the Cayley tree with branching ratio  $k$ . We consider the nearest neighbor Ising model, where spins  $\sigma_x = \pm 1$  have a Gibbs distribution at temperature  $T = 1/\beta$  with boundary conditions  $\eta$  in a finite volume  $\Lambda$  given by

$$(1) \quad \mu(\sigma) = Z^{-1} \exp \left\{ \beta \sum_{\langle x,y \rangle} J_{xy} \sigma_x \sigma_y + \beta \sum_{\langle x,y \rangle} J_{xy} \sigma_x \eta_y \right\}$$

It is known that there is a critical temperature  $T_{\text{cr}} = 1/\text{arctanh}(1/k)$  for the ferromagnetic case. For  $T > T_{\text{cr}}$  there is a unique infinite volume Gibbs distribution and below that critical temperature, there is spontaneous magnetization in the sense that, always for the ferromagnetic model, plus and minus boundary conditions give opposite non-zero magnetizations:

$$\langle \sigma_0 \rangle_{\pm}^T = \pm m^*(T), \quad m^*(T) > 0 \text{ when } T < T_{\text{cr}}$$

There is yet another special temperature,  $T_{\text{SG}} = 1/\text{arctanh}(1/\sqrt{k})$ , called the spin-glass temperature. For the ferromagnetic model it is known that the free state, the infinite volume Gibbs distribution obtained by putting  $\eta \equiv 0$  in (1) is extreme for  $T > T_{\text{SG}}$  while it is not for  $T < T_{\text{SG}}$  ([1],[2]). The question is to find the extremal decomposition of the free state  $\langle \cdot \rangle_{\emptyset}^T$ .

To find it, let  $D$  be a subset of bonds of the tree  $\tau_k$ , and consider the two Ising spin configurations  $\sigma^{D,\pm}$  on  $\tau_k$  defined as:

$$(2) \quad \sigma_0^{D,+} = +1, \quad \sigma_0^{D,-} = -1$$

and

$$\begin{aligned} \sigma_x^{D,\pm} &= -\sigma_y^{D,\pm} & \text{for } (x,y) \in D \\ \sigma_x^{D,\pm} &= +\sigma_y^{D,\pm} & \text{for } (x,y) \notin D \end{aligned}$$

That is, fix the value of the spin of the root say 0 to be  $+1$  or  $-1$ , then the nearest neighbours sites of both configurations alternate when they belong to the set  $D$ .

By  $\langle \cdot \rangle_{\sigma^{D,\omega}}^T$  we denote the Gibbs state of the ferromagnetic Ising model at inverse temperature  $T$  with the boundary condition  $\sigma^{D,\omega}$  where  $\omega = \pm 1$  corresponds to the way the spin at the origin is chosen

Let  $p \in (0, 1)$ . Take the set  $D$  to be random: every bond decides to be in  $D$  with probability  $p$  independently of the other bonds. Denote by  $\mathbb{E}_p$  the expectation with respect to that process.

**Proposition 1.** *The following decomposition of the free state for the ferromagnetic Ising model on the tree holds for all temperatures  $T$ ,*

$$(3) \quad \langle \cdot \rangle_{\emptyset}^T = \frac{1}{2} \mathbb{E}_{p(T)} [\langle \cdot \rangle_{\sigma^{D,+}}^T + \langle \cdot \rangle_{\sigma^{D,-}}^T]$$

where

$$p(T) = \frac{1}{2} [1 - \tanh 1/T]$$

This decomposition holds for any temperature. But at high temperature all the states in the rhs are the same. The important point is that at low temperatures they are all different extremal states, with  $\langle \cdot \rangle_{\emptyset}^T$ - probability 1. That follows from the results of [3].

I think that the same behavior one encounters on the Lobachevsky plane, compare with [4].

## REFERENCES

- [1] P.M. Bleher, Extremity of the Disordered Phase in the Ising Model on the Bethe Lattice. *Commun. Math. Phys.* **128**: 411–419 (1990).
- [2] P.M. Bleher, J. Ruiz and V. Zagrebnov, On the purity of the limiting Gibbs state for the Ising model on the Bethe lattice, *J. Stat. Phys.* **79**, 473–482 (1995).
- [3] D. Gandolfo, J. Ruiz, and S.B. Shlosman, A Manifold of Pure Gibbs States of the Ising Model on a Cayley tree. *J. Stat. Phys.* **148**, 999–1005 (2012).
- [4] Gandolfo, D., Ruiz, J. and Shlosman, S., A manifold of pure Gibbs states of the Ising model on the Lobachevsky plane. *Communications in Mathematical Physics*, 334(1), pp. 313–330 (2015).

## Random interchange model and Poisson-Dirichlet distribution

DANIEL UELTSCHI

The random interchange model is closely related to the quantum Heisenberg model [9]. Given a graph  $G = (V, E)$ , and  $t \in \mathbb{N}$ , consider a random sequence  $(e_1, \dots, e_t)$  of edges in  $E$ , and the corresponding random permutation

$$\sigma_t = \tau_{e_t} \circ \dots \circ \tau_{e_1}.$$

Here,  $\tau_{e_i}$  denotes the transposition of the endpoints of the edge  $e_i$ . The main question deals with the cycle structure of  $\sigma_t$ . All cycles are short when  $t$  is small, but a phase transition may take place when  $t$  increases, where some cycles have lengths of order  $|V|$ .

The cycles are always shorter than the percolation clusters that are formed by the edges that have been selected at least once. Schramm studied this model on the complete graph [7]. With  $t = cn$  with  $c$  large enough so that a percolation cluster of macroscopic size is present, Schramm proved that the cycle structure of  $\sigma_t$  follows an effective split-merge process, and displays Poisson-Dirichlet distribution  $\text{PD}(1)$  (this was suggested by Aldous).

It turns out that this heuristics can be extended to general loop soup models [5, 10]. Besides, Tóth's interchange model involves the weight  $2^{\#\text{cycles}(\sigma_t)}$ , which suggests that the relevant distribution is  $\text{PD}(2)$ . With Jakob Björnberg and Jürg Fröhlich, we have studied the model on the complete graph with weight  $\theta^{\#\text{cycles}(\sigma_t)}$ , where the parameter  $\theta$  takes values  $2, 3, 4, \dots$ . We essentially prove that the cycle structure is given by the  $\text{PD}(\theta)$  distribution [4]. The precise statement involves the function

$$f(s) = \frac{1}{\theta} \left( e^{-\frac{\theta-1}{2}s} + e^{-\frac{\theta+1}{2}s} + \dots + e^{\frac{\theta-1}{2}s} \right).$$

Notice that  $f(s) = \cosh \frac{s}{2}$  when  $\theta = 2$ .

**Theorem 1.** *Consider the complete graph of  $n$  vertices and let  $t = \beta n$ . The parameter  $\theta$  must be an integer greater or equal to 2. Then there exists  $m = m(\beta, \theta)$  such that for all  $h \in \mathbb{C}$ , we have*

$$(1) \quad \lim_{n \rightarrow \infty} \mathbb{E}_n \left[ \prod_{i \geq 1} f\left(\frac{h \ell_i}{n}\right) \right] = \mathbb{E}_{\text{PD}(\theta)} \left[ \prod_{i \geq 1} f(hmX_i) \right].$$

Further,  $m > 0$  when  $\beta > \beta_c$ , where

$$\beta_c = \begin{cases} 2 & \text{if } \theta = 2, \\ 2 \frac{\theta-1}{\theta-2} \log(\theta-1) & \text{if } \theta = 3, 4, \dots \end{cases}$$

The first product in Eq. (1) is over the cycles of  $\sigma_t$ ;  $\ell_i$  denotes the length of the  $i$ th cycle. The second product is over the elements  $X_i$  of the random partition with distribution  $\text{PD}(\theta)$ .

The critical parameter  $\beta_c$  is equal to the one of the random cluster model on the complete graph with  $q = \theta$  and  $p = 1 - e^{-\beta/n}$ .

The proof for  $\theta = 2$  is not hard. It is based on a conjecture of Tom Spencer for the quantum Heisenberg model, and calculations using additions of spins. This is



actually similar to Penrose's article [6], which was motivated by [8]. The case  $\theta = 3, 4, \dots$  is considerably more complex. We use the theory of symmetric polynomials and certain identities obtained by Alon and Kozma [1], Berestycki and Kozma [2], and Björnberg [3].

We would like to claim that Theorem 1 establishes the presence of Poisson-Dirichlet in the random interchange model on the complete graph. It involves specific classes of characteristic functions. It remains to clarify whether this characterisation is sufficient.

#### REFERENCES

- [1] G. Alon, G. Kozma, *The probability of long cycles in interchange processes*, Duke Mathematical Journal 162(9), 1567–1585 (2013)
- [2] N. Berestycki, G. Kozma, *Cycle structure of the interchange process and representation theory*, Bull. Soc. Math. France 143, 265–281 (2015)
- [3] J.E. Björnberg, *The free energy in a class of quantum spin systems and interchange processes*, J. Math. Phys. 57, 073303 (2016)
- [4] J.E. Björnberg, J. Fröhlich, D. Ueltschi, in preparation
- [5] C. Goldschmidt, D. Ueltschi, P. Windridge, *Quantum Heisenberg models and their probabilistic representations*, in Entropy and the Quantum II, Contemp. Math. 552, 177–224 (2011); arXiv:1104.0983
- [6] O. Penrose, *Bose-Einstein condensation in an exactly soluble system of interacting particles*, J. Statist. Phys. 63, 761–781 (1991)
- [7] O. Schramm, *Compositions of random transpositions*, Israel J. Math. 147, 221–243 (2005)
- [8] B. Tóth, *Phase transition in an interacting Bose system — an application of the theory of Venttsel' and Friedlin*, J. Statist. Phys. 61, 749–764 (1990)
- [9] B. Tóth, *Improved lower bound on the thermodynamic pressure of the spin 1/2 Heisenberg ferromagnet*, Lett. Math. Phys. 28, 75–84 (1993)
- [10] D. Ueltschi, *Universal behaviour of 3D loop soup models*, arXiv:1703.09503 (2017)

### Fine mesh limit of 1D VRJP, inversion of Ray-Knight and Bass-Burdzy flows

TITUS LUPU

(joint work with Christoph Sabot and Pierre Tarres)

The Vertex Reinforced Jump Process (VRJP) is a model of reinforced walk on an electrical network. The jump rate from  $x$  to a neighbour  $y$  at time  $t$  is given by  $C(x, y)L_t(y)$ , where  $C(x, y)$  is a fixed conductance and  $L_t(y)$  is the reinforcement factor:

$$L_t(y) = 1 + \text{time spent in } y \text{ before } t.$$

Sabot and Tarres [2] showed that a VRJP is a mixture of time-changed Markov jump process. Together with Sabot and Tarres [5], we considered the rescaled VRJP on  $2^{-n}\mathbb{Z}$  and showed that there is a regime for the reinforcement such that the process converges in law to a continuous reinforced diffusion on  $\mathbb{R}$ , which we called Linearly Reinforced Motion (LRM). We have two constructions of it. One as a time-changed diffusion in random potential

$$\mathcal{V}(x) = \sqrt{2}B(x) + |x|,$$

where  $(B(x))_{x \in \mathbb{R}}$  is an  $\mathbb{R}$ -parametrized Brownian motion. The second construction uses a convergent Bass-Burdzy flow [1], the flow of solutions to

$$\frac{dY_u}{du} = \begin{cases} -1 & \text{if } Y_u > W_u, \\ 1 & \text{if } Y_u < W_u, \end{cases}$$

where  $(W_u)_{u \geq 0}$  is a Brownian motion. We also considered a divergent Bass-Burdzy flow

$$\frac{dY_u}{du} = \begin{cases} 1 & \text{if } Y_u > W_u, \\ -1 & \text{if } Y_u < W_u, \end{cases}$$

and showed that out of it one can construct a dereinforced diffusion, which a.s. exhausts the initial local time at some location. The dereinforced version is related to the inversion of the second Ray-Knight theorem. This completes the results obtained previously on inversion of Ray-Knight by Sabot and Tarres [3] and Lupu, Sabot and Tarres [4].

#### REFERENCES

- [1] Richard F. Bass and Krzysztof Burdzy. Stochastic bifurcation model. *The Annals of Probability*, 27(1):50–108, 1999.
- [2] Christophe Sabot and Pierre Tarres. Edge-reinforced random walk, vertex-reinforced jump process and the supersymmetric hyperbolic sigma model. *Journal of the European Mathematical Society*, 17(9):2353–2378, 2015.
- [3] Christophe Sabot and Pierre Tarres. Inverting Ray-Knight identity. *Probability Theory and Related Fields*, 165 :559–580, 2016.
- [4] Titus Lupu, Christophe Sabot and Pierre Tarres. Inverting the coupling of the signed Gaussian free field with a loop soup. arXiv preprint arXiv:1701.01092, 2017.
- [5] Titus Lupu, Christophe Sabot and Pierre Tarres. Scaling limit of the VRJP in dimension one and Bass-Burdzy flow. Preprint, 2018.

## Emerging planarity of Pfaffian structures of the long-range Ising model

HUGO DUMINIL-COPIN

(joint work with M. Aizenman, V. Tassion and S. Warzel)

In this talk, the known Pfaffian structure of the boundary spin correlations, and more generally order-disorder correlation functions, is given a new explanation through simple topological considerations within the model's random current representation. This perspective is then employed in the proof that the Pfaffian structure of boundary correlations emerges asymptotically at criticality in Ising models on  $\mathbb{Z}^2$  with finite-range interactions. The analysis is enabled by new results on the stochastic geometry of the corresponding random currents [4, 1]. The proven statement establishes an aspect of universality, seen here in the emergence of fermionic structures in two dimensions beyond the solvable cases.

The Ising model is perhaps the most studied example of a system undergoing a phase transition. In the following discussion, the symbol  $G = (V(G), E(G))$  denotes a finite graph with vertex-set  $V(G)$  and edge-set  $E(G)$ . A *planar* graph is a graph embedded in the plane  $\mathbb{R}^2$  in such a way that its edges, depicted by bounded simple arcs, intersect only at their endpoints.

A configuration of Ising spin variables on a graph  $G$  is a binary valued function  $\sigma : V(G) \mapsto \{-1, 1\}$ . The Hamiltonian of the model is the function, defined on the configurations  $\sigma \in \{\pm 1\}^{V(G)}$ , given by

$$\mathbf{H}_G(\sigma) := - \sum_{\{x,y\} \in E(G)} J_{x,y} \sigma_x \sigma_y.$$

Its parameters  $J := \{J_{x,y}\}_{\{x,y\} \in E(G)}$  are referred to as the *coupling* coefficients. The corresponding Gibbs equilibrium state at inverse temperature  $\beta \geq 0$  is the probability measure such that

$$\langle f \rangle_{G,\beta} := \frac{\sum_{\sigma \in \{\pm 1\}^{V(G)}} f(\sigma) \exp(-\beta \mathbf{H}_G(\sigma))}{2^{|V(G)|} Z(G, \beta)}$$

for any  $f : \{\pm 1\}^{V(G)} \rightarrow \mathbb{C}$ , where  $Z(G, \beta)$  is the normalizing factor.

Groeneveld-Boel-Kasteleyn [3] first pointed out that for planar Ising systems, the correlation functions for spins located along the boundaries are given at any temperature by Pfaffians of the corresponding two point function, i.e. satisfy a *fermionic* version of Wick rule.

For a more explicit statement, let us recall that the Pfaffian of an upper triangular array  $A = [A_{i,j}]_{1 \leq i < j \leq 2n}$  is defined as

$$\text{Pfaff}_n(A) := \sum_{\pi \in \Pi_n} \text{sign}(\pi) A_{\pi(1),\pi(2)} \cdots A_{\pi(2n-1),\pi(2n)},$$

where  $\Pi_n$  is the collection of pairings of  $\{1, \dots, 2n\}$  and  $\text{sign}(\pi)$  the pairing's signature. A *pairing* of  $\{1, \dots, 2n\}$  is a permutation  $\pi$  such that  $\pi(2j-1) < \pi(2j)$  for any  $j \in \{1, \dots, n\}$  and  $\pi(2j-1) < \pi(2j+1)$  for any  $j \in \{1, \dots, n-1\}$ .

The above quoted result of Groeneveld-Boel-Kasteleyn [3] reads as follows. Fix a planar graph  $G$ , arbitrary nearest-neighbor couplings  $J$ , and  $\beta \geq 0$ . Then, for any cyclically ordered  $2n$ -tuple  $(x_1, \dots, x_{2n})$  of sites located along the boundary of a fixed face of  $G$ , we have

$$(1) \quad \langle \sigma_{x_1} \cdots \sigma_{x_{2n}} \rangle_{G,\beta} = \text{Pfaff}_n([\langle \sigma_{x_i} \sigma_{x_j} \rangle_{G,\beta}]_{1 \leq i < j \leq 2n}).$$

The previous relation can be viewed as the fermionic counterpart of the Wick rule of the (bosonic) correlations of Gaussian fields. The fermionic denomination comes from the fact that Pfaffians are a familiar feature of the vacuum expectation values of products of Majorana spinors, and of the thermal equilibrium states of systems of *non-interacting* fermions.

The main result presented in this talk is the following extension of (1) to finite-range models on the half space  $\mathbb{H} := \mathbb{Z} \times \mathbb{Z}_+$ . In the non-planar case the Pfaffian relations no longer hold in the strict sense. However, we prove in [2] that the Pfaffian structure of correlations re-emerges at the critical points, as an asymptotic relation at large spin separations. Let  $J$  be a set of coupling constants for an Ising model over the upper half-plane  $\mathbb{H}$  which are:

- (i) ferromagnetic, i.e. that  $J_{x,y} \geq 0$  for every  $x, y \in \mathbb{H}$ ,
- (ii) finite-range and such that the associated graph is connected,
- (iii) translation invariant, i.e. that  $J_{x,y} = J(x-y)$ , and

(iv) reflection invariant:  $J_{0,(a,b)} = J_{0,(-a,b)} = J_{0,(a,-b)} = J_{0,(b,a)}$  for every  $a, b \in \mathbb{Z}$ .

Then, for any collection of boundary points  $x_1 = (k_1, 0), \dots, x_{2n} = (k_{2n}, 0)$  satisfying  $k_1 < k_2 < \dots < k_{2n}$ , we have

$$\langle \sigma_{x_1} \cdots \sigma_{x_{2n}} \rangle_{\mathbb{H}, \beta_c} = \text{Pfaff}_n([\langle \sigma_{x_i} \sigma_{x_j} \rangle_{\mathbb{H}, \beta_c}]_{1 \leq i < j \leq 2n}) [1 + o(1)],$$

where  $\beta_c$  is the critical inverse-temperature of the model, and  $o(1)$  is a function of the points  $x_1, \dots, x_{2n}$  which tends to zero for configuration sequences with  $\min_{1 \leq i < j \leq 2n} \{|x_i - x_j|\} \rightarrow \infty$ .

## REFERENCES

- [1] M. Aizenman, *Geometric analysis of  $\varphi^4$  fields and Ising models*, Comm. Math. Phys. **86**(1) (1982), 1–48.
- [2] M. Aizenman, H. Duminil-Copin, V. Tassion and S. Warzel *Emergent Planarity in two-dimensional Ising Models with finite-range Interactions*, arXiv:1801.04960.
- [3] J. Groeneveld, R.J. Boel and P.W. Kasteleyn, *Correlation-function identities for general planar Ising systems*, Physica, **93A** (1978), 138–154.
- [4] R. B. Griffiths, C. A. Hurst, and S. Sherman, *Concavity of magnetization of an Ising ferromagnet in a positive external field*, J. Math. Phys. **11** (1970), 790–795.

## Asymptotics of even-even correlations in the Ising model

YVAN VELENIK

(joint work with Sébastien Ott)

Consider the Ising model on  $\mathbb{Z}^d$ ,  $d \geq 2$ , with formal Hamiltonian

$$\mathcal{H} = -\beta \sum_{\substack{\{i,j\} \subset \mathbb{Z}^d: \\ \|i-j\|=1}} \sigma_i \sigma_j,$$

where, as usual,  $\sigma_i$  denotes the random variable corresponding to the spin at  $i \in \mathbb{Z}^d$ . (Note that the results below actually apply to a general class of finite-range ferromagnetic 2-body interactions.)

It is well known that there exists a critical value  $\beta_c = \beta_c(d) \in (0, \infty)$  of the parameter  $\beta$  such that there is a unique (infinite-volume) Gibbs measure when  $\beta < \beta_c$ , but not when  $\beta > \beta_c$ . (A pedagogical introduction to this model can be found in [9].)

From now on, assume that  $\beta < \beta_c$  and denote by  $\mu_\beta$  the unique infinite-volume Gibbs measure. In this regime, spin-spin correlations decay exponentially fast: it was proved in [2] that, for any unit vector  $\mathbf{u}$  in  $\mathbb{R}^d$ ,

$$\xi_\beta(\mathbf{u}) = - \lim_{n \rightarrow \infty} \frac{1}{n} \log \text{Cov}_\beta(\sigma_0, \sigma_{[n\mathbf{u}]})$$

exists and is positive. In the latter expression, the covariance is computed with respect to  $\mu_\beta$ , and  $[y] \in \mathbb{Z}^d$  denotes the component-wise integer part of  $y \in \mathbb{R}^d$ .

Given  $C \Subset \mathbb{Z}^d$  (that is,  $C \subset \mathbb{Z}^d$  with a cardinality  $|C| < \infty$ ), denote by  $\sigma_C = \prod_{i \in C} \sigma_i$ . It is easy to check that any local function can be written as a finite linear combination of such functions.

The main question in this work is: how do the covariances

$$\text{Cov}_\beta(\sigma_A, \sigma_{B+[n\mathbf{u}]}) ,$$

with  $A, B \Subset \mathbb{Z}^d$ , behave as  $n \rightarrow \infty$ . Observe that, by symmetry,  $\text{Cov}_\beta(\sigma_A, \sigma_B) = 0$  whenever  $|A|$  and  $|B|$  have different parities. We can therefore assume, without loss of generality, that  $|A|$  and  $|B|$  are either both odd, or both even: one then says that one considers odd-odd, resp. even-even, correlations.

*Odd-odd correlations.* In this case, the best nonperturbative result to date is the following:

**Theorem 1** ([7]). *Let  $A, B \Subset \mathbb{Z}^d$  be two sets of odd cardinality. Then, for any  $d \geq 2$ , any  $\beta < \beta_c$  and any unit vector  $\mathbf{u}$  in  $\mathbb{R}^d$ , there exists a constant  $0 < C < \infty$  (depending on  $A, B, \mathbf{u}, \beta$ ) such that*

$$\text{Cov}_\beta(\sigma_A, \sigma_{B+[n\mathbf{u}]}) = \frac{C}{n^{(d-1)/2}} e^{-\xi_\beta(\mathbf{u})n} (1 + o(1)),$$

as  $n \rightarrow \infty$ .

This result has a long history, starting with the celebrated work by Ornstein and Zernike in 1914 [11, 15], in which the corresponding claim is established (non-rigorously) when  $|A| = |B| = 1$ . (Obviously they did not consider the Ising model, which Lenz invented only in 1920, but their approach does apply to this model.)

The first rigorous derivations in the case  $|A| = |B| = 1$ , valid in any dimension but only for sufficiently small  $\beta$ , were obtained in [1] and [13]. The first version valid for arbitrary  $\beta < \beta_c$  was given in [6] (see also [8]).

Extensions to general odd-odd correlations were first obtained in [3, 4] and [16, 10], again for sufficiently small values of  $\beta$ , and then in [7] for all  $\beta < \beta_c$ .

*Even-even correlations.* This case is more delicate. The first case analyzed was that of energy-energy correlations, that is, when  $A$  and  $B$  are both composed of a pair of nearest-neighbor vertices. Although it was quickly clear that the rate of exponential decay is given in this case by  $2\xi_\beta(\mathbf{u})$ , the determination of the prefactor led to some controversy: Camp and Fisher [5] predicted a prefactor of order  $n^{-d}$  for all  $d \geq 2$ , while Polyakov [14] predicted a prefactor of order  $n^{-2}$  when  $d = 2$ ,  $(n \log n)^{-2}$  when  $d = 3$  and  $n^{-(d-1)}$  when  $d \geq 4$ . It turned out that Polyakov's predictions were correct. This was first proved, for small enough values of  $\beta$ , in [3, 4] for dimensions  $d \geq 4$ , and in [16, 10] for dimensions 2 and 3. Extensions to general even-even correlations, at small values of  $\beta$ , were proved in [16, 10].

Our main result is the following non-perturbative derivation.

**Theorem 2.** *Let  $A, B \Subset \mathbb{Z}^d$  be two sets of even cardinality. Then, for any  $d \geq 2$ , any  $\beta < \beta_c$  and any unit vector  $\mathbf{u}$  in  $\mathbb{R}^d$ , there exist constants  $0 < C_- \leq C_+ < \infty$*

(depending on  $A, B, \mathbf{u}, \beta$ ) such that, for all  $n$  large enough,

$$\frac{C_-}{\Xi(n)} e^{-2\xi_\beta(\mathbf{u})n} \leq \text{Cov}_\beta(\sigma_A, \sigma_{B+[n\mathbf{u}]}) \leq \frac{C_+}{\Xi(n)} e^{-2\xi_\beta(\mathbf{u})n},$$

with

$$\Xi(n) = \begin{cases} n^2 & \text{when } d = 2, \\ (n \log n)^2 & \text{when } d = 3, \\ n^{d-1} & \text{when } d \geq 4. \end{cases}$$

*Open problems.* A number of interesting problems remain open at this stage.

- In contrast to the result for odd-odd correlations, the theorem above only provides bounds, not sharp asymptotics. It would be desirable to remove this limitation. One possible approach may be to build a version of the Ornstein–Zernike theory, as developed in [6, 8, 12] directly in the random-current representation.
- An extension to more general models, in particular with a richer symmetry group, would be highly desirable. This seems delicate even for Potts models.

## REFERENCES

- [1] D. B. Abraham and H. Kunz, *Ornstein-Zernike theory of classical fluids at low density*, Phys. Rev. Lett. **39** (1977), 1011–1014.
- [2] M. Aizenman, D. J. Barsky, and R. Fernández, *The phase transition in a general class of Ising-type models is sharp*, J. Statist. Phys. **47** (1987), 343–374.
- [3] J. Bricmont and J. Fröhlich, *Statistical mechanical methods in particle structure analysis of lattice field theories. I. General theory*, Nuclear Phys. B **251** (1985), 517–552.
- [4] J. Bricmont and J. Fröhlich, *Statistical mechanical methods in particle structure analysis of lattice field theories. II. Scalar and surface models*, Comm. Math. Phys. **98** (1985), 553–578.
- [5] W. J. Camp and M. E. Fisher, *Behavior of two-point correlation functions at high temperatures*, Phys. Rev. Lett. **26** (1971), 73–77.
- [6] M. Campanino, D. Ioffe, and Y. Velenik, *Ornstein-Zernike theory for finite range Ising models above  $T_c$* , Probab. Theory Related Fields **125** (2003), 305–349.
- [7] M. Campanino, D. Ioffe, and Y. Velenik, *Random path representation and sharp correlations asymptotics at high-temperatures*, Adv. Stud. Pure Math. **39** (2004), 29–52.
- [8] M. Campanino, D. Ioffe, and Y. Velenik, *Fluctuation theory of connectivities for subcritical random cluster models*, Ann. Probab. **36** (2008), 1287–1321.
- [9] S. Friedli and Y. Velenik, *Statistical Mechanics of Lattice Systems: A Concrete Mathematical Introduction*, Cambridge University Press, 2017.
- [10] R. A. Minlos and E. A. Zhizhina, *Asymptotics of decay of correlations for lattice spin fields at high temperatures. I. The Ising model*, J. Statist. Phys. **84** (1996), 85–118.
- [11] L. S. Ornstein and F. Zernike, *Accidental deviations of density and opalescence at the critical point of a single substance*, Proc. Akad. Sci. **17** (1914), 793–806.
- [12] S. Ott and Y. Velenik, *Potts models with a defect line*. Preprint, *arXiv:1706.09130*, 2017.
- [13] P. J. Paes-Leme, *Ornstein-Zernike and analyticity properties for classical lattice spin systems*, Ann. Physics **115** (1978), 367–387.
- [14] A. M. Polyakov, *Microscopic description of critical phenomena*, J. Exp. Theor. Phys. **28** (1969), 533–539.

- [15] F. Zernike, *The clustering-tendency of the molecules in the critical state and the extinction of light caused thereby*, Koninklijke Nederlandse Akademie van Wetenschappen Proceedings Series B Physical Sciences **18** (1916), 1520–1527.
- [16] E. A. Zhizhina and R. A. Minlos, *Asymptotics of the decay of correlations for Gibbs spin fields*, Teoret. Mat. Fiz. **77** (1988), 3–12.

## On macroscopic holes in some dependent percolation models

ALAIN-SOL SZNITMAN

We consider on  $\mathbb{Z}^d$ ,  $d \geq 3$ , the vacant set of random interacements in the strongly percolative regime, the vacant set of the simple random walk, and the excursion set of the Gaussian free field in the strongly percolative regime. We present asymptotic upper and lower exponential bounds for the large deviation probability that the adequately thickened component of the boundary of a large box centered at the origin in the respective vacant sets or excursion set leaves in the box a macroscopic volume in its complement. We also present geometric controls on the shape of the left-out volume. The results heavily rely on a recent article in collaboration with Maximilian Nitzschner.

### REFERENCES

- [1] M. Nitzschner. Disconnection by level sets of the discrete Gaussian free field and entropic repulsion. *Preprint*, also available at arXiv:1802.02518.
- [2] M. Nitzschner and A.S. Sznitman. Solidification of porous interfaces and disconnection. Accepted for publication at the *J. Eur. Math. Soc.*, also available at arXiv:1706.07229.
- [3] A.S. Sznitman. On macroscopic holes in some supercritical strongly dependent percolation models. *Preprint*, also available at arXiv:1802.05255.

## Ensembles of self-avoiding polygons

LORENZO TAGGI

(joint work with V. Betz)

Self-avoiding random walks are by now a classical topic of modern probability theory, although many questions still remain to be answered; we refer to the classic book [28] and the more recent survey [32]. A variant of self-avoiding walks are self-avoiding polygons (see e.g. [23]), where the last step of the self-avoiding walk has to come back to the point of origin. In most of the literature, a single random walk or polygon is the object of study. In the present paper, we instead investigate properties of random polygons interacting with an environment consisting of other random polygons. As we will detail below, a natural way to view these systems is as random permutations on a graph.

Specifically, we are interested in the behavior of step-weighted self-avoiding directed polygon ensembles. In the context of the single step-weighted self-avoiding walk, the following interesting and rather complete picture is known: fix a sequence of growing subsets  $\Lambda_n$  of  $\mathbb{Z}^d$ , for example the cubes of side length  $n$ . Fix in addition, for each  $n$ , two points  $a$  and  $z$  at opposite ends of  $\Lambda_n$ , and consider the set of all

self-avoiding walks starting in  $a$  and ending in  $z$ . Let  $\alpha \in \mathbb{R}$ , and assign to each such self-avoiding walk  $X$  the weight  $\exp(-\alpha|X|)$ , where  $|X|$  is the number of steps that  $X$  takes. Write  $\mu$  for the connective constant of the  $d$ -dimensional cubic lattice. When  $\alpha > \log \mu$ , it is known that the shape of  $X$  converges to a straight line as  $n \rightarrow \infty$ , when scaled by  $1/n$ . Actually, when scaled by  $1/n$  in the direction of  $a - z$  and by  $n^{-1/2}$  in the directions perpendicular to this vector,  $X$  converges to a Brownian Bridge. These results are implicit in the works [10, 12] and have been worked out by Y. Kovchegov in his thesis [26].

For  $\alpha < \log \mu$ , on the other hand, the results are entirely different. As Dominik Copin, Kozma and Yadin have recently shown [15], in this case the rescaled self-avoiding walk becomes *weakly space filling*, meaning that it will only leave holes of logarithmic size in the graph [15]. Their results also hold for the self-avoiding loop, i.e. in the case where  $a$  and  $z$  are chosen to be the same site. Note that for  $\alpha > \log \mu$ , the self-avoiding *loop* will converge to a point in the scaling limit.

Let us now present our model of interacting, self-avoiding directed loops, and outline our main results. Some of our results work for general graphs, so we formulate our model in that language. Let  $V$  be a finite set and  $E \subset \{\{x, y\} : x, y \in V, x \neq y\}$ , so that  $G = (V, E)$  is a finite, simple, undirected graph. We consider the set  $S_G$  of permutations  $\pi : V \rightarrow V$  such that for all  $z \in V$ , either  $\pi(z) = z$  or  $\{z, \pi(z)\} \in E$ . The energy  $\mathcal{H}_G$  of a permutation  $\pi$  is just the total number of edges used by that permutation, i.e.

$$(1) \quad \mathcal{H}_G(\pi) = \sum_{z \in V} \mathbb{1}\{\pi(z) \neq z\}.$$

For  $\alpha > 0$ , the relevant probability measure then is

$$(2) \quad \mathbb{P}_G(\pi) = \frac{e^{-\alpha \mathcal{H}_G(\pi)}}{Z(G)},$$

where the *partition function*  $Z(G)$  normalizes the Boltzmann weights  $e^{-\alpha \mathcal{H}_G(\pi)}$  to a probability measure.

Clearly, an element of  $S_G$  under  $\mathbb{P}_G$  can be interpreted as an ensemble of edge-weighted, oriented, self-avoiding polygons in  $G$ : the polygons are now just the cycles of the permutation  $\pi$ . In the other direction, the single self-avoiding polygon containing a point  $a$  can be interpreted as the measure  $\mathbb{P}_G$  conditioned on the non-existence of any cycle besides the one starting in  $a$ . A different interesting interpretation of (2), which we will not pursue any further here, would be to see  $\pi$  as a random directed subgraph of  $G$  with the condition that the indegree and outdegree of each vertex must be either both equal to one or both equal to zero.

We can now ask the same questions as discussed above: if we make  $\alpha$  small, will the cycle starting from the point  $a$  be weakly space filling with positive probability? Will a cycle connecting  $a$  to  $z$  collapse to a straight line in the scaling limit when  $\alpha$  is large? Where is the boundary  $\alpha_0$  between these two behaviours, assuming there is one? In this paper, we can only give partial answers to these questions. We have no result about the existence of a space filling cycle, which is unfortunate since this is by far the most interesting question; see below why this is so. Instead,



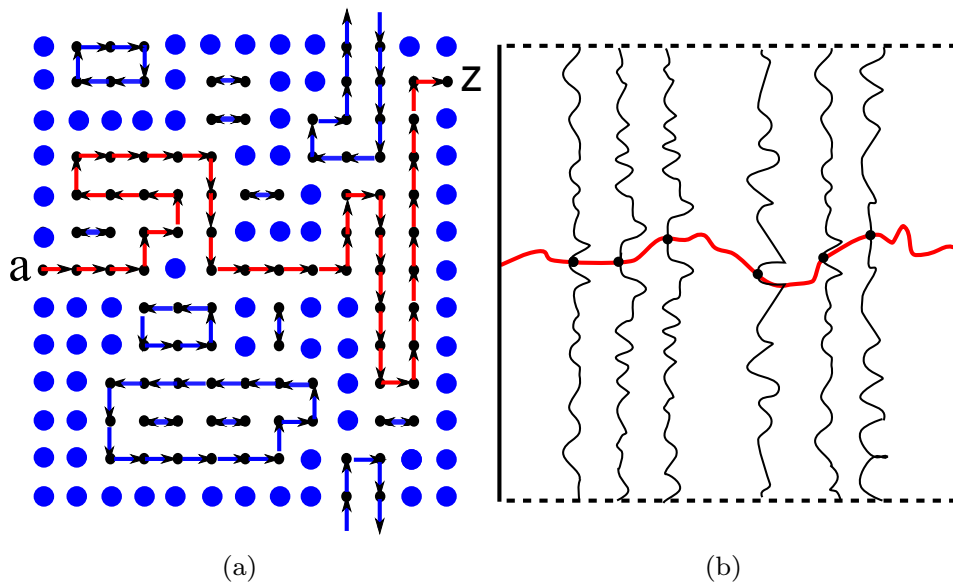

FIGURE 1. **(a)**: Representation of a bijection with a forced open cycle between  $a$  and  $z$ , when  $\Lambda \subset \mathbb{Z}^2$  is a box with cylinder boundary conditions. If  $\pi(x) = x$ , then a circle is drawn at  $x$ , while if  $\pi(x)$  is a neighbour of  $x$ , then an arrow is directed from  $x$  to  $\pi(x)$ . **(b)**: Regeneration interfaces intersect the forced open cycle at regeneration points, which are represented by small black circles.

we show that *if* there is a regime of space filling cycles, it must start at lower  $\alpha$  than for the case of the self-avoiding polygon. More precisely, in the case where  $G$  is a subgraph of a vertex transitive graph, and when  $\mu$  is the *cyclic* connective constant of that graph, then we identify in [8][Theorem 1] an  $\alpha_0 < \log \mu$  so that for all  $\alpha > \alpha_0$ , and uniformly in the size of  $G$ , the length of a cycle through a given point has exponential tails. Thus in the interval  $(\alpha_0, \log \mu)$  the single self-avoiding loop is weakly space filling while the self-avoiding loop embedded into an ensemble of other such loops is very short.

Our second main result, which requires most of the work, is [8][Theorem 2]. The model here is again the one where a self-avoiding path originating in a point  $a$  and ending in a point  $z$  (on the opposite side of the graph) is forced through the system. Figure 1(a) shows a typical configuration. We give a positive answer to the question about collapse to a straight line for large  $\alpha$ . Unlike in the case of the single self-avoiding loop, we do not have a good quantitative estimate on the threshold above which this behavior holds, and we cannot quite control the scaling well enough to prove the convergence to a Brownian bridge. The reason for these shortcomings is that we have to fight much more serious correlations than are present in the self-avoiding walk case. We will try to give a short account of these difficulties and our way to overcome them toward the end of this introduction. Before we do this,

let us briefly comment on the original reason why we are interested in the model, and on the reason why a regime of space-filling cycles would be most interesting.

The original interest in random permutations on a graph, or more generally spatial random permutation, comes from connections to quantum physics and specifically to Bose-Einstein condensation. Consider a finite subset  $X$  of a finite box  $\Lambda_n \subset \mathbb{R}^d$  of side length  $n$ . The number of points of  $X$  should scale with the volume of that box. We consider the complete graph on  $X$ , but with edge weights  $d(x, y) = |x - y|^2$ , the set  $S_X$  of permutations of  $X$ , and the measure (2) but with energy

$$(3) \quad \mathcal{H}_G = \sum_{x \in X} d(x, \pi(x)).$$

Here, we set  $d(x, x) = 0$  for all  $x$ . On the one hand, the relation of this model to (2) should be apparent. On the other hand, (3) is precisely a spatial random permutation as introduced in [5]. In that paper it is also explained that the partition function of the annealed version of (3) (i.e. where we average over the positions of the points  $X \subset \Lambda_n$ ) precisely corresponds to the partition function of the free Bose gas, and it is shown that for dimensions 3 and higher, there is indeed a critical value  $\alpha_0 > 0$  so that for  $\alpha < \alpha_0$ , the cycle starting from a given point  $x_0$  contains a fraction of all the available sites with positive probability, uniformly in the size of the system  $n$ . For this model, we even know the precise asymptotic distribution of long cycles [4, 6].

In [34] it is shown how for the interacting Bose gas, off-diagonal long range order (a well known criterion for the occurrence of Bose-Einstein condensation due to Penrose and Onsager [30]) occurs precisely when the ratio of two specific partition functions stays strictly positive as  $n \rightarrow \infty$ . The partition function in the denominator is the one corresponding to the annealed version of (3), but with a complicated additional interaction potential originating from the interactions of the Bosons. The partition function in the numerator is the same except that for two points  $a$  and  $z$  at the boundary of  $\Lambda_n$ , a cycle is started in  $a$  and forced to end in  $z$ . Apart from the annealing of the points different from  $a$  and  $z$ , this is precisely the situation of the forced cycle that we will treat in [8][Theorem 2]. It is believed (but there is no rigorous proof) that the ratio of these two partition functions will remain positive if and only if the probabilistic model without the forced open cycle develops cycles with volume order length; or, if the forced open cycle does *not* collapse to a straight line in the scaling limit, but is space weakly filling in some sense. Thus it would be very desirable to have a proof of the existence of long (volume order) cycles in any model of the type (2), but unfortunately existing results [4, 5, 6] are restricted to cases where the model has an explicit, tractable representation in Fourier space. Any attempt to get away from this very restrictive situation has so far failed. In [7] a non-rigorous argument is made that the study of models of non-spatial permutations with cycle weights may be useful, and such models have received some attention recently [3, 9, 11]. Also, there is very clear numerical evidence [20, 21, 2] for the existence of a regime with long cycles. Nevertheless, the question remains unsolved.

Further relations of spatial random permutations to quantum physics and other interesting problems of mathematical physics exist. Here is not the place to describe them all in detail, but we should at least mention the important work of Balint Toth on the ferromagnetic Heisenberg model and ensembles of mutually self-avoiding walks [33], the random stirring models introduced by Harris [24] and further analysed in [1, 31, 25], and some (speculative) connections to the theory of Schramm-Löwner evolutions in two dimensions [2]. The latter work is interesting in relation to the present paper because in it, the geometry of the forced cycle between  $a$  and  $z$  was studied numerically. From the numerical evidence it was not entirely clear whether for large  $\alpha$ , the fractal dimension of the rescaled, forced cycle would be strictly larger than one for all  $\alpha > 0$ , or would be equal to one above a critical value of  $\alpha$ . The results of the present paper answer this question at least for large enough  $\alpha$ : the second option is true.

Another important connection is to the loop  $O(n)$  model, which has been introduced in [17]. In this model a loop configuration  $\omega$  is an undirected spanning subgraph of a graph  $G$  such that every vertex of this subgraph has degree zero or two. The weight of a loop configuration is proportional to  $e^{-\alpha o(\omega)} n^{L(\omega)}$ , where  $o(\omega)$  is the number of edges in  $\omega$ ,  $L(\omega)$  is the number of loops and  $n$  is a positive real. The case  $n = 0$  corresponds formally to self-avoiding walk if one forces a path in the system in addition to the loops. The case  $n = 1$  corresponds to the low-temperature representation of the Ising model. If viewed as an ensemble of cycles, spatial random permutations are intimately related to the loop  $O(n)$  model with  $n = 2$ , since each cycle of the permutation admits two possible orientations. The two models would be equivalent if in spatial random permutations cycles of length two were forbidden. On the hexagonal lattice, the loop  $O(n)$  model has been conjectured to undergo a Kosterlitz-Thouless phase transition at the critical threshold  $\log(\sqrt{2 + \sqrt{2 - n}})$  when  $n \leq 2$  [27]. This is compatible with our general finding that on every vertex-transitive graph the critical threshold of spatial random permutations, which corresponds more or less to the  $n = 2$  case, is strictly less than the critical threshold for the self-avoiding walk, corresponding to the  $n = 0$  case. Furthermore, it has been conjectured that only short cycles are observed at all values of  $\alpha$  when  $n > 2$ . This has been rigorously proved only for  $n$  large enough in the article of Duminil-Copin, Peled, Samotij, and Spinka in [16], who also provide details on the structure of the typical configurations and provide evidence for the occurrence of a phase transition. Exploring the properties of the model at low values of  $n$  is of great interest and entirely open. Most of the proofs that we present in this paper, can be reproduced for the loop  $O(n)$  model for all values of  $n$  and  $\alpha$  large enough, without the restriction of considering the hexagonal lattice.

Let us close this introduction by discussing the specific difficulties of the model of spatial permutations, and the methods that we use to overcome them. The main obstacle in the study of spatial random permutations is that we have no good estimates about the decay of correlations in the model. Put differently, whenever we condition on having a certain cycle configuration within some even very small

set of sites, we have no good tools to estimate how the law of cycles outside that set is affected by such conditioning. This problem is most pronounced for small  $\alpha$ , where (alleged) long cycles carry correlations through the system. Such a difficulty is not present in statistical mechanics models where independence between sites is assumed, as for example in Bernoulli percolation, and it is overcome in Ising-type models in the high-temperature regime by introducing a coupling that makes a comparison with a subcritical percolation model (FK-percolation), implying exponential decay of correlations (Edward-Sokal coupling [19]). This coupling is not available in our model. The main technical novelty of our paper is the method of *iterative sampling* which can be used to prove exponential decay of correlations for  $\alpha$  large enough. In a nutshell, iterative sampling describes a way of sampling a spatial random permutation essentially cycle by cycle. This allows to devise coupling arguments: start sampling two random permutations from two different configurations, in each step compare the space occupied by the cycles sampled up to now, and decide based on that information where to sample next. Stop when the shape of the occupied space is equal in both instances, and fill the remaining space with the same randomly sampled permutation in both models. If this happens before a region  $A$  is reached, then everything in  $A$  is independent of the initial conditions. The probability that this happens is dominated by the probability of a certain Galton-Watson process to die out. The offspring distribution of that Galton-Watson-process is in turn dominated by the cycle length distribution of the random permutation. By using [8][Theorem 1], we infer that for large enough  $\alpha$  the method will work.

The proof of [8][Theorem 1] itself is rather short and does not use iterative sampling. An intuition as to why the theorem is true is the following: in self-avoiding walks the probability of a given walk is just proportional to a Boltzmann weight with parameter  $\alpha$  and energy proportional to its length. Instead, in random permutations the energy of the walk under investigation is the same as in the self-avoiding walk case, but there is an additional entropy cost that comes by forcing all other cycles to be not connected to the vertices visited by such a given walk. Having a good estimate of this entropy cost is not easy, as this depends not only on the length of the walk, but also on its shape; we thus have to estimate partition functions for different subgraphs of  $G$ , which is a task of high combinatorial complexity. The estimates we do get are rather crude, but are uniform over the shape of the cycle and good enough to prove the shift in the critical value,  $\alpha_0 < \log(\mu)$ .

For the proof of [8][Theorem 2], we extend the very general approach of Ornstein-Zernike theory to the case of spatial random permutations on a cubic lattice. The Ornstein-Zernike theory [29] gives a sharp asymptotic description of density correlation functions in classical fluids away from the critical point. Although Ornstein and Zernike examined only the classical fluid, it has since then been realized that their conclusions should apply also to the two-point functions of many lattice spin systems, as the Ising model [13], Bernoulli Percolation [14] and Self-Avoiding Walks [10, 12]. In our case, we do not deal with a two-point function, but with the

decay of the probability that the open cycle connecting the two opposite sides of the box will ever leave a cylinder of radius  $f(n) = c\sqrt{n}(\log n)^{\frac{5}{2}}$  whose axis is the straight line connecting the starting point to the other opposite box side. Although the setting is a bit different, the approach of Ornstein-Zernike theory applies also to our case, proving decay of this probability with  $n$  if  $\alpha$  is large enough and  $c$  is large enough depending on  $\alpha$ .

We now describe the method for self-avoiding walks and then explain which difficulties have to be overcome in order to extend it to spatial random permutations. Even though the self-avoiding walk has no Markov property, we can recover some amount of independence by identifying so-called *regeneration points*, which are points where the hyperplane perpendicular to  $z - a$  is crossed only once. One can then show that these regeneration points are distributed like the steps of a random walk which is biased in the direction of  $z - a$ . Then the central limit theorem leads us to the conclusion that these points are all contained in the cylinder of radius  $\sqrt{n}$  with high probability. After that, one needs to prove that not only these selected points, but the whole path is entirely contained in the cylinder with high probability. This requires showing that long excursions between consecutive regeneration points are too expensive in terms of energy. In order the entire argument to work, it is necessary to prove that the distance between regeneration points is of much smaller order than the size of the box, giving that the whole path presents many regeneration points with high probability. In self-avoiding walks, this is proved by showing that the directed correlation function of walks with no regeneration points has a strictly larger decay rate than the correlation function with no such restriction. This property is referred to as *mass-gap condition*.

In random permutations, the existence of regeneration points is much more difficult to prove. One reason is that, while the energy of the forced cycle is of the order of its length, even for very large  $\alpha$  the total energy of all the other cycles combined is always of the order of the volume. So an argument along the lines that a cycle with few regeneration points must be longer and thus unlikely needs to isolate a sub-dominant contribution from the total energy of the system. A second reason is that, if we do have a regeneration point for the open cycle, independence of the future from the past is compromised by the existence of small cycles that connect both of them. The first difficulty is overcome by using iterative sampling and thus obtaining exponential decay of correlations. In a sense, one can “ignore” what happens to the permutation far from the open cycle and consider only the contribution from the sites which are not too far from the open cycle. More specifically, in the fundamental lemma (see [8] we prove that with high probability as  $n$  is large, the length of the open cycle till its last intersection with the hyperplane having a distance  $L(n)$  from its starting point is not larger than  $(1 + \delta)L(n)$  for a given  $\delta > 0$ . In order this to hold true,  $L(n)$  must be taken larger than  $K \log n$  for a certain  $K > 0$  large enough, which is necessary to compensate the polynomial growth of the cardinality of the boundary, recovering independence from the boundary.

The second difficulty is overcome by introducing the notion of *regeneration interfaces*. These are sets of sites which intersect the forced open cycle at the regeneration point and split the lattice into disjoint regions whose boundaries are not crossed by any cycle (see also Figure 1(b)). Using the domain Markov property of spatial random permutations we then achieve the desired independence. A regeneration point intersecting a regeneration interface is called *regeneration centre*, and we want to show that all regeneration centres lie approximately on a straight line with high probability, as  $n$  is large. While in the self-avoiding walks regeneration points are distributed as the steps of a Markovian random walk, in spatial permutations the situation is more complicated: while regeneration interfaces form a (set-valued) Markov chain, the sequence regeneration centres itself does not have the Markov property. The argument that worked in the case of the self-avoiding walks can however be saved when one requires the existence of regeneration interfaces with certain symmetry properties; this existence is guaranteed by yet another (slightly different) variant of iterative sampling. For such symmetric regeneration interfaces, the sequence of regeneration centres is a martingale, and the result ultimately follows from Azuma's inequality.

While the distance between regeneration points in self-avoiding walks is  $O(1)$ , the best we can prove is that in random permutations, the distance between regeneration centres is at most of order  $O((\log n)^2)$ . This is still good enough for proving collapse to a straight line, but no longer good enough for convergence to a Brownian Bridge in the appropriate scaling. Showing the  $O((\log n)^2)$ -statement is done by comparing the partition functions of permutations with no regeneration centres in a given set with the partition function of all permutations. We show that the ratio between the two partition functions decays fast with the size of the set, uniformly on the size of the box. In a sense, this property is equivalent to the mass-gap condition for self-avoiding walks. We call this property *mass-gap condition for spatial random permutations* and we elaborate more on its connection to self-avoiding walks in [8].

## REFERENCES

- [1] N. Berestycki: *Emergence of giant cycles and slowdown transition in random transpositions and  $k$ -cycles*. Electron. J. Probab. 16, 152-173 (2011).
- [2] V. Betz: *Random permutations of a regular lattice*. J. Stat. Phys., Volume 155, Issue 6, pp 1222-1248, (2014).
- [3] V. Betz, D. Ueltschi, Y. Velenik: *Random permutations with cycle weights*. Ann. Appl. Probab. Volume 21, pp 312-331, (2011).
- [4] V. Betz, D. Ueltschi: *Spatial random permutations and Poisson-Dirichlet law of cycle lengths*. Electron. J. Probab. Volume 16, Issue 41, (2011).
- [5] V. Betz, D. Ueltschi: *Spatial random permutations and infinite cycles*. Comm. Math. Phys. 285, 469-501 (2009)
- [6] V. Betz, D. Ueltschi: *Spatial random permutations with small cycle weights*. Probab. Th. Rel. Fields 149, 191-222 (2011).
- [7] V. Betz, D. Ueltschi: *Critical temperature of dilute Bose gases*. Phys. Rev. A **81**, 023611 (2010).
- [8] V. Betz, L. Taggi: *Ensembles of self-avoiding polygons*. ArXiv: 1612.07234.

- [9] L. V. Bogachev, D. Zeindler: *Asymptotic statistics of cycles in surrogate-spatial permutations*. Comm. Math. Phys. 334, 1, p. 39-116.
- [10] J.T.Chayes and L.Chayes: *Ornstein-Zernike Behavior for Self-Avoiding Walks at All Non-critical Temperatures*. Comm. Math. Phys. 105, 2, 221-238 (1986)-
- [11] N.M. Ercolani, D. Ueltschi: *Cycle structure of random permutations with cycle weights*. Random Struct. Algor. 44, 109-133
- [12] D. Ioffe: *Ornstein-Zernike Behaviour and Analyticity of Shapes for Self-Avoiding Walks On  $\mathbb{Z}^d$* . Markov Processes and Related Fields 4 (1998), 324-350.
- [13] M. Campanino, D. Ioffe, and Y. Velenik: *Ornstein-Zernike theory for finite range Ising models above  $T_c$* . Probability Theory and Related Fields 125(3):305-349 (2003)
- [14] M. Campanino and D. Ioffe: *Ornstein-Zernike theory for the Bernoulli bond percolation on  $\mathbb{Z}^d$* . Ann. Probab., Volume 30, Number 2 (2002), 652-682.
- [15] H. Duminil-Copin, G. Kozma, and A. Yadin: *Supercritical self-avoiding walks are space-filling*. Ann. Inst. H. Poincaré Probab. Statist., Volume 50, Number 2, pp 315-326, 2014.
- [16] H. Duminil-Copin, R. Peled, W. Samotij, and Y. Spinka: *Exponential decay of loop lengths in the loop  $O(n)$  model with large  $n$* . ArXiv: 1412.8326v3. Accepted on Comm. Math. Phys.
- [17] E. Domany, D. Mukamel, B. Nienhuis, and A. Schwimmer: *Duality relations and equivalences for models with  $O(n)$  and cubic symmetry*, Nuclear Physics B 190 (1981), no. 2, 279-287.
- [18] M. Draief and L. Massouli: *Epidemics and Rumours in Complex Networks*. London Mathematical Society Lecture Note Series: 369.
- [19] R. G. Edwards and A. D. Sokal: *Generalization of the Fortuin-Kasteleyn- Swendsen-Wang representation and Monte Carlo algorithm*. Phys. Rev. D (3) 38 (1988), no. 6, 2009–2012.
- [20] D. Gandolfo, J. Ruiz, D. Ueltschi: *On a model of random cycles*. J. Statist. Phys. 129, 663-676 (2007).
- [21] S. Grosskinsky, A. A. Lovisolo, D. Ueltschi: *Lattice permutations and Poisson-Dirichlet distribution of cycle lengths*. J. Statist. Phys. 146, 1105-1121 (2012).
- [22] J. M. Hammersley and D. C. Morton: *Poor man's Monte Carlo*. J. Roy. Stat. Soc. B, 16:23-38 (1954).
- [23] J. M. Hammersley: *The number of polygons on a lattice*. Mathematical Proceedings of the Cambridge Philosophical Society, Volume 57, Issue 3, pp. 516-523 (1961).
- [24] T. E. Harris: *Nearest-neighbor Markov interaction processes on multidimensional lattices*. Adv. Math. 9, pp. 66-89 (1972)
- [25] R. Kotecky, P. Milos, D. Ueltschi: *The random interchange process on the hypercube*. Electron. Comm. Probab. 21, no. 4 (2016).
- [26] Y. Kovchegov: *Brownian bridge in percolation, self-avoiding walks and related processes*. Ph.D thesis, Department of Mathematics, Stanford University, 2002.
- [27] B. Nienhuis: *Exact Critical Point and Critical Exponents of  $O(n)$  Models in Two Dimensions*. Phys. Rev. Lett., Volume 49, Number 15, (1982).
- [28] N. Madras, G. Slade: *The Self-Avoiding Walk*. Birkhäuser (2013), reprint of the 1996 Edition. DOI 10.1007/978-1-4614-6025-1.
- [29] L. S. Ornstein, F. Zernike: Proc. Acad. Sci. (Amst.) 17, 793–806 (1915).
- [30] O. Penrose, L. Onsager: *Bose-Einstein condensation and liquid Helium*. Phys. Rev. 104, 576 (1956)
- [31] O. Schramm: *Compositions of random transpositions*. Isr. J. Math. 147, 221-243 (2005).
- [32] G. Slade: *The self-avoiding walk: a brief survey*. in *Surveys in Stochastic Processes*, J. Blath, P. Imkeller, S. Roelly (eds.), European Mathematical Society (2011).
- [33] B. Toth: *Improved lower bound on the thermodynamic pressure of the spin 1/2 Heisenberg ferromagnet*. Lett. Math. Phys. 28, 75-84 (1993)
- [34] D. Ueltschi: *Relation between Feynman Cycles and Off-Diagonal Long-Range Order*. Phys. Rev. Lett. 97, 170601 (2006).

## Open problems about Abelian sandpiles

ANTAL A. JÁRAI

### 1. ABELIAN SANDPILE MODEL

Let  $G = (V \cup \{s\}, E)$  be a finite connected graph, where the special vertex  $s$  is called the **sink**. A **sandpile** is a collection of indistinguishable particles on the non-sink vertices, usually denoted  $\eta : V \rightarrow \{0, 1, 2, \dots\}$ . A sandpile is **stable**, if  $\eta(x) < \deg_G(x)$  for all  $x \in V$ . A **toppling** is the following operation: if  $\eta(x) \geq \deg_G(x)$ , then  $x$  can ‘fire’ (topple), and send one particle along each edge of  $G$  incident with  $x$ . Any particles reaching the sink are lost. If more than one toppling is possible, their order does not matter: given any sandpile  $\eta$ , if one carries out topplings until no more topplings are possible, the same stable sandpile  $\eta^\circ$  is obtained, regardless of the order.

A Markov chain on the set of stable sandpiles is obtained in the following way: at each step, pick a random vertex in  $V$ , add a particle there, and stabilize via topplings. The set of topplings carried out in one step is called an ‘avalanche’. We denote by  $\nu_G$  the invariant distribution. See the surveys [3, 15, 5] for a lot of further background.

### 2. SANDPILE MEASURES.

The ‘infinite volume limit’ of  $\nu_G$  is well-understood. Let  $V_1 \subset V_2 \subset \dots$  be an exhaustion of a locally finite, infinite graph  $G = (V, E)$ . Consider  $G_n = (V_n \cup \{s\}, E_n)$ , where  $s$  is  $V \setminus V_n$  collapsed to a single vertex. It was shown in [8] that if all components of the wired uniform spanning forest of  $G$  are one-ended, then  $\nu_{G_n} \Rightarrow \nu$ , where  $\nu$  is called the **sandpile measure** on  $G$ . Let us pick a sample  $\eta$  from  $\nu$ . Let  $o \in V$  be a fixed vertex, and define the **avalanche cluster** as:

$$Av = Av(\eta) = \{x \in V : x \text{ topples when a particle is added to } \eta \text{ at } o\}.$$

Let us further assume now that  $G$  is vertex-transitive. The following is known via a combination of results of [11, 6]. If  $G$  is transient, then avalanches are  $\nu$ -a.s. finite, that is:  $\nu[|Av| < \infty] = 1$ . In fact, the total number of topplings in the avalanche (counted with multiplicity) is also finite:  $\nu[\#\text{topplings} < \infty] = 1$ .

*Open Problem 1.* Are avalanches  $\nu$ -a.s. finite on  $\mathbb{Z}^2$ ?

*Background.* The following identity is known as Dhar’s formula [2]:

$$(1) \quad \mathbb{E}_{\nu_n} [\#\text{topplings at } x \text{ if we add at } o] = \mathcal{G}_{V_n}(o, x),$$

where  $\mathcal{G}_{V_n}$  is the Dirichlet Green’s function for the continuous-time simple random walk in  $V_n$  (killed when it hits  $s$ ). On transient graphs this remains finite as  $V_n \uparrow V$ , but diverges on  $\mathbb{Z}^2$  [1]. If one could show that on  $\mathbb{Z}^2$  we have  $\nu[\#\text{topplings at } o < \infty] = 1$ , then Open Problem 1 would follow [1]. The main difficulty seems to be to control multiple topplings. In contrast with (1), we have no convenient formula for:

$$\mathbb{E}_{\nu_n} [(\#\text{topplings at } x)(\#\text{topplings at } y)]$$



or

$$\mathbb{E}_{\nu_n}[\#\text{topplings at } x \mid x \text{ topples}].$$

### 3. TOPPLING PROBABILITY EXPONENT

By analogy with other statistical physics models, it is natural to conjecture that

$$\nu[x \in \text{Av}] \approx \frac{1}{|x|^{d-2+\eta}}, \quad \text{with } \eta = \eta(d) \geq 0.$$

It is known from [7] that  $\eta = 0$  when  $d \geq 5$ , and one expects a logarithmic correction to this exponent in  $d = 4$ . There is numerical work in progress (joint with M. Sun) that suggests  $\eta(2) \approx 0.42$  and  $\eta(3) \approx 0.06$ . The following problem concerns the scaling limit of the toppling probability.

*Open Problem 2.* Show that when  $d \geq 5$ , there exists a function  $f_d : (-1, 1)^d \rightarrow (0, \infty)$  such that for the sandpile on  $V_L = [-L, L]^d \cap \mathbb{Z}^d$  we have

$$\nu_L[x \in \text{Av}] \sim |x|^{2-d} f_d(x/L), \quad \text{as } L \rightarrow \infty,$$

uniformly in  $x$ , at least as long as  $x$  is bounded away from 0. Is there an analogue in low dimensions?

### 4. AVALANCHE SIZE

Several further questions about critical exponents are open in low dimensions.

*Open Problem 3.* What is the tail behaviour of  $\nu[|\text{Av}| > t]$  on  $\mathbb{Z}^d$ ,  $d \geq 2$ ?<sup>1</sup>

### 5. SCALING LIMIT OF HEIGHT CORRELATIONS

Correlations between sites with no particles can be computed. It is shown in [12] that on  $\mathbb{Z}^d$ ,  $d \geq 2$  one has

$$\text{Cov}_\nu(\eta(o) = 0; \eta(x) = 0) \sim -c(d) |x|^{-2d}, \quad \text{as } |x| \rightarrow \infty.$$

In 2D [4] shows the following: let  $D \subset \mathbb{C}$  be a bounded, smooth domain, and consider the sandpile on  $D \cap (\varepsilon\mathbb{Z}^2)$  with invariant distribution  $\nu_\varepsilon$ . Consider the ‘height 0 field’, centred:  $h^\varepsilon(z) = \mathbf{1}_{\eta(z)=0} - \nu_\varepsilon[\eta(z) = 0]$ ,  $z \in D \cap (\varepsilon\mathbb{Z}^2)$ . Then for any distinct points  $z_1, \dots, z_k \in D$  we have

$$\varepsilon^{-2k} \mathbb{E}_{\nu_\varepsilon} [h^\varepsilon(z_1) \cdots h^\varepsilon(z_k)] \xrightarrow{\varepsilon \downarrow 0} \Phi_D(z_1, \dots, z_k),$$

where the limiting correlation function  $\Phi_D$  is conformally covariant: if  $\varphi : D \rightarrow D'$  is conformal, then

$$\Phi_{D'}(\varphi(z_1), \dots, \varphi(z_k)) = \prod_{i=1}^k |\varphi'(z_i)|^2 \Phi_D(z_1, \dots, z_k).$$

When  $k = 2$ , one has the explicit formula:

$$\Phi_D(z_1, z_2) = (\partial_{x_1} \partial_{x_2} \mathcal{G}_D)^2 + (\partial_{x_1} \partial_{y_2} \mathcal{G}_D)^2 + (\partial_{y_1} \partial_{x_2} \mathcal{G}_D)^2 + (\partial_{y_1} \partial_{y_2} \mathcal{G}_D)^2,$$

<sup>1</sup>During the workshop, T. Hutchcroft informed us of a proof that when  $d \geq 5$ , this probability is of order  $t^{-1/2}$ .

where  $z_j = x_j + iy_j$  and  $\mathcal{G}_D = \mathcal{G}_D(z_1, z_2)$  is the Dirichlet Green's function for Brownian motion. The function  $\Phi_D(z_1, z_2)$  formally equals the covariance of the generalized field  $|\nabla h|^2$ : where  $h$  is the Gaussian free field in  $D$ .

*Open Problem 4.* Does  $h^\varepsilon$  converge to  $|\nabla h|^2$ : in a suitable space?

Regarding other height variables, [9] shows that on  $\mathbb{Z}^2$  we have

$$(2) \quad \text{Cov}_\nu(\eta(o) = 0; \eta(x) = i) \sim a_i (\log |x|) |x|^{-4}, \quad \text{as } |x| \rightarrow \infty, i = 1, 2, 3.$$

They conjecture:

$$(3) \quad \text{Cov}_\nu(\eta(o) = i; \eta(x) = j) \sim a_{i,j} (\log^2 |x|) |x|^{-4}, \quad \text{as } |x| \rightarrow \infty, i, j = 1, 2, 3.$$

*Open Problem 5.* Prove the conjecture (3).

The following is some background for the above conjecture. Let  $p(i) = \nu[\eta(o) = i]$ ,  $i = 0, 1, 2, 3$  (where  $d = 2$ ). The value of  $p(0)$  is known from [12]. The work [14] gave explicit expressions for  $p(i)$ ,  $i = 1, 2, 3$  in terms of some singular integrals. The result (2) is obtained by an extension of Priezzhev's method. More recently, [10] found a method to compute connection probabilities in groves, and this enables to compute the  $p(i)$ 's as well as other finite dimensional marginals of  $\nu$ . This is based on a bijection between recurrent sandpiles and spanning trees [13].

#### REFERENCES

- [1] S. Bhupatiraju, J. Hanson and A.A. Járai, *Inequalities for critical exponents in  $d$ -dimensional sandpiles*, Electron. J. Probab. **22** (2017), paper no. 1, 1–51.
- [2] D. Dhar, *Self-organized critical state of sandpile automaton models*, Phys. Rev. Lett. **64** (1990), 1613–1616.
- [3] D. Dhar, *Theoretical studies of self-organized criticality*, Phys. A **369** (2006), 29–70.
- [4] M. Dürre, *Conformal covariance of the abelian sandpile height one field*, Stochastic Process. Appl. **119** (2009), 2725–2743.
- [5] A.A. Járai, *Sandpile models*, Preprint (2014), [arXiv:1401.0354](https://arxiv.org/abs/1401.0354)
- [6] A.A. Járai and F. Redig, *Infinite volume limit of the Abelian sandpile model in dimensions  $d \geq 3$* , Probab. Theory Related Fields **141** (2008), 181–212.
- [7] A.A. Járai, F. Redig and E. Saada, *Approaching criticality via the zero dissipation limit in the abelian avalanche model*, J. Stat. Phys. **159** (2015), 1369–1407.
- [8] A.A. Járai and N. Werning, *Minimal configurations and sandpile measures*, J. Theoret. Probab. **27** (2014), 153–167.
- [9] M. Jeng, G. Piroux, P. Ruelle *Height variables in the Abelian sandpile model: scaling fields and correlations*, J. Stat. Mech. Theory Exp. (2006), P10015+63.
- [10] R.W. Kenyon and D.B. Wilson, *Spanning trees of graphs on surfaces and the intensity of loop-erased random walk on planar graphs*, J. Amer. Math. Soc. **28** (2015), 985–1030.
- [11] R. Lyons, B.J. Morris and O. Schramm, *Ends in uniform spanning forests*, Electron. J. Probab. **13** (2008), Paper no. 58.
- [12] S.N. Majumdar and D. Dhar, *Height correlations in the Abelian sandpile model*, J. Phys. A **24** (1991), L357–L362.
- [13] S.N. Majumdar and D. Dhar, *Equivalence between the Abelian sandpile model and the  $q \rightarrow 0$  limit of the Potts model*, Phys. A **185** (1992), 129–145.
- [14] V.B. Priezzhev, *Structure of two-dimensional sandpile. I. Height probabilities*, J. Statist. Phys. **74** (1994), 955–979.
- [15] F. Redig, *Mathematical aspects of the abelian sandpile model*, Mathematical statistical physics (2006), 657–729, Elsevier B.V., Amsterdam.

## Phase transition in the loop $O(n)$ model

ALEXANDER GLAZMAN

(joint work with Nick Crawford, Hugo Duminil-Copin, Ioan Manolescu, Ron Peled, and Yinon Spinka)

The loop  $O(n)$  model is a model for a random collection of non-intersecting loops on the hexagonal lattice, which is believed to be in the same universality class as the spin  $O(n)$  model. It has been predicted by Nienhuis that for  $0 \leq n \leq 2$ , the loop  $O(n)$  model exhibits a phase transition at a critical parameter  $x_c(n) = 1/\sqrt{2 + \sqrt{2 - n}}$ . For  $0 < n \leq 2$ , the transition line has been further conjectured to separate a regime with short loops when  $x < x_c(n)$  from a regime with macroscopic loops when  $x \geq x_c(n)$ . Prior known results deal with either with the Ising model ( $n = 1$ ) [1, 11, 12] or with large enough  $n$  [6]; see [7] for a survey. In this talk we state several new results partially confirming the Nienhuis' conjecture.

In [5], we prove that for  $n \in [1, 2]$  and  $x = x_c(n)$ , the loop  $O(n)$  model exhibits macroscopic loops. This is the first instance in which a loop  $O(n)$  model with  $n \neq 1$  is shown to exhibit such behavior. Prior known results see [6]. A main tool in the proof is a new positive association (FKG) property shown to hold when  $n \geq 1$  and  $0 < x \leq \frac{1}{\sqrt{n}}$ . More precisely, we assign to each hexagon spin  $\pm 1$  in such a way that neighbouring hexagons get different signs if and only if they are separated by an edge of the loop configuration. Then the FKG property states that any two increasing (in terms of spins) events are positively correlated. This property implies, using techniques recently developed for the random-cluster model, the following dichotomy: either long loops are exponentially unlikely or the origin is surrounded by loops at any scale (box-crossing property). We develop a 'domain gluing' technique which allows us to employ Smirnov's parafermionic observable to rule out the first alternative when  $n \in [1, 2]$  and  $x = x_c(n)$ .

In [4], we consider the case  $n = 2$  and  $x = 1$ . This model is in direct correspondence with the uniform distribution on Lipschitz functions on the triangular lattice, i.e. all integer-valued functions which differ by 0 or 1 on any two adjacent vertices. We show that the loop  $O(2)$  model at  $x = 1$  exhibits infinitely many loops going around the origin. In particular, this implies that the variance of a uniformly distributed random Lipschitz function on the triangular lattice is infinite. Prior known results establish flat behaviour in higher dimension [8], on trees [9], and on expanders [10]. Thus, we provide the first instance in which a uniformly distributed Lipschitz function was shown to exhibit a rough behaviour. A main tool in the proof is an FKG property that is different from the one stated above. First one needs to colour loops in red and blue independently with equal probability. The colouring of loops allows to view the loop  $O(2)$  model with  $x = 1$  as coupling of two percolation configurations, and it turns out that marginal measure on each of them is positively associated. Studying each of these percolation configurations independently and using the XOR operation we establish existence of macroscopic loops, i.e. level lines in the original setting.

In [3], we show that the loop  $O(n)$  model in the regime of exponential decay when  $n > 1$  and  $x < \frac{1}{\sqrt{3}}$ , and exhibits loops of macroscopic length when  $n = 1$  and  $x \in (1, \sqrt{3}]$ . The proof of the exponential decay is based on developing in  $n$  and comparing the loop  $O(n)$  model with  $n > 1$  to the loop  $O(1)$  model, i.e. Ising model, where this statement is known. The proof of the existence of long loops in the Ising model ( $n = 1$ ) when  $x \in (1, \sqrt{3}]$  is based on the Edwards-Sokal coupling and the XOR argument. Note that independently it was shown [2] that the anti-ferromagnetic Ising model ( $n = 1, x > 1$ ) exhibits macroscopic domain walls, i.e. loops in the loop  $O(1)$  representation, when  $x \in (1, 1 + \epsilon)$  for  $\epsilon$  small enough.

#### REFERENCES

- [1] M. Aizenman, D. J. Barsky, and R. Fernández. The phase transition in a general class of Ising-type models is sharp. *J. Statist. Phys.*, 47(3-4):343–374, 1987.
- [2] V. Beffara and D. Gayet. Percolation without FKG. arXiv:1710.10644, 2017.
- [3] N. Crawford, A. Glazman, I. Manolescu, and R. Peled. Parts of the loop  $O(n)$  model phase diagram. in preparation, 2018+.
- [4] H. Duminil-Copin, A. Glazman, and I. Manolescu. Lipschitz functions on the triangular lattice are typically rough. in preparation, 2018+.
- [5] H. Duminil-Copin, A. Glazman, R. Peled, and Y. Spinka. Macroscopic loops in the loop  $O(n)$  model at Nienhuis’ critical point. arXiv:1707.09335, 2017.
- [6] H. Duminil-Copin, R. Peled, W. Samotij, and Y. Spinka. Exponential decay of loop lengths in the loop  $O(n)$  model with large  $n$ . *Communications in Mathematical Physics*, 349(3):777–817, 12 2017.
- [7] R. Peled and Y. Spinka. Lectures on the spin and loop  $O(n)$  models. arXiv:1708.00058, 2017.
- [8] Ron Peled. High-dimensional Lipschitz functions are typically flat. *Ann. Probab.*, 45(3):1351–1447, 2017.
- [9] Ron Peled, Wojciech Samotij, and Amir Yehudayoff. Grounded Lipschitz functions on trees are typically flat. *Electron. Commun. Probab.*, 18:no. 55, 9, 2013.
- [10] Ron Peled, Wojciech Samotij, and Amir Yehudayoff. Lipschitz functions on expanders are typically flat. *Combin. Probab. Comput.*, 22(4):566–591, 2013.
- [11] Stanislav Smirnov. Conformal invariance in random cluster models. I. Holomorphic fermions in the Ising model. *Ann. of Math. (2)*, 172(2):1435–1467, 2010.
- [12] Vincent Tassion. Crossing probabilities for voronoi percolation. arXiv:1410.6773, 2014.

### Mallows permutations: stable matchings and scaling

OMER ANGEL

(joint work with Alexander Holroyd, Thomas Hutchcroft, Avi Levy)

Mallows permutations. The **Mallows measure** defined in [7], denoted  $\text{Mal}_q^n$  on permutations of  $\{1, \dots, n\}$  with parameter  $q \in [0, 1]$  is the probability measure that assigns to each permutation  $\sigma \in S_n$  a probability proportional to  $q^{\text{inv}(\sigma)}$ , where  $\text{inv}(\sigma)$  is the **inversion number** of  $\sigma$ , given by

$$\text{inv}(\sigma) = \#\{(i, j) : i < j \text{ and } \sigma(i) > \sigma(j)\}.$$

More generally, define the Mallows measure  $\text{Mal}_q^I$  on permutations of a general finite interval  $I \subseteq \mathbb{Z}$  by shifting the indices. The Mallows measure was extended to permutations of infinite intervals by Gnedin and Olshanski [5, 6], who showed that

for  $q \in [0, 1)$ , the measures  $\text{Mal}_q^{[-n, n]}$  converge weakly (pointwise) to a probability measure  $\text{Mal}_q^{\mathbb{Z}}$  on permutations of  $\mathbb{Z}$ . We call this limit the Mallows measure on permutations of  $\mathbb{Z}$  with parameter  $q$ . The Mallows permutation of  $\mathbb{Z}$ , together with its compositions with shifts, are the only Gibbs measures on permutations of  $\mathbb{Z}$  with respect to the Hamiltonian  $H(\sigma) = \text{inv}(\sigma)$  and inverse temperature  $\beta = -\log q$ , and are also the stationary measures of the multi-type asymmetric simple exclusion process.

Mallows as stable matchings. In [1], we show that the Mallows measure on permutations of a finite  $I \subset \mathbb{Z}$  arises as the law of the unique Gale-Shapley stable matching (see [3]) of the random bipartite graph conditioned to be perfect, where preferences arise from a total ordering of the vertices but are restricted to the (random) edges of the graph. We extend this correspondence to infinite intervals, for which the situation is more intricate. We prove that almost surely every stable matching of the random bipartite graph obtained by performing Bernoulli percolation on the complete bipartite graph  $K_{\mathbb{Z}, \mathbb{Z}}$  falls into one of two classes: a countable family  $(\sigma_n)_{n \in \mathbb{Z}}$  of *tame* stable matchings, in which the length of the longest edge crossing  $k$  is  $O(\log |k|)$  as  $k \rightarrow \pm\infty$ , and an uncountable family of *wild* stable matchings, in which this length is  $\exp \Omega(k)$  as  $k \rightarrow +\infty$ . The tame stable matching  $\sigma_n$  has the law of the Mallows permutation of  $\mathbb{Z}$  composed with the shift  $k \mapsto k + n$ . The permutation  $\sigma_{n+1}$  dominates  $\sigma_n$  pointwise, and the two permutations are related by a shift along a random strictly increasing sequence. Scaling of Mallows cycles. In a future paper, we study the scaling limit of the cycles of the Mallows permutation of  $\mathbb{Z}$ , as  $q \rightarrow 1$ . Let  $q = 1 - \varepsilon$ . It was shown by Gladkich and Peled [4] that the cycle of 0 typically has length and diameter of order  $\varepsilon^2$ . Associate to each cycle  $C$  a measure on  $\mathbb{R}$  defined by

$$\mu_C := \varepsilon^2 \sum_{n \in C} \delta_{\varepsilon^2 n},$$

so that the sum of the measures over all cycles converge to Lebesgue measure. We prove that the measure of the cycle containing 0 (or any other  $n$ ) converges in law to some random measure with continuous Radon-Nikodym derivative with respect to Lebesgue. Moreover, for each  $t \in \mathbb{R}$ , the densities of the measures at  $t$  give a partition  $X_t$  of unity with Poisson-Dirichlet law. Finally, we characterize the evolution of the partitions  $X_t$  as a special case of the Ethier-Kurtz diffusion arising in population dynamics [2]. Our arguments extend to a number of other permutation models, suggesting that the same large scale cycle structure appears in a large universality class of permutations.

## REFERENCES

- [1] O. Angel, A. E. Holroyd, T. Hutchcroft, and A. Levy, *Mallows permutations as stable matchings*, arXiv:1802.07142.
- [2] S. N. Ethier and T. G. Kurtz *The Infinitely-Many-Neutral-Alleles Diffusion Model*, Advances in Applied Probability 13 (1981), No. 3, 429–452.
- [3] D. Gale and L. Shapley, *College admissions and the stability of marriage*, The American Mathematical Monthly 69 (1962), no. 1, 9–15.

- [4] A. Gladkikh and R. Peled, *On the Cycle Structure of Mallows Permutations*, The Annals of Probability (to appear); arXiv:1601.06991.
- [5] A. Gnedin and G. Olshanski, *q-exchangeability via quasi-invariance*, The Annals of Probability 38 (2010), no. 6, 2103–2135, arXiv:0907.3275.
- [6] A. Gnedin and G. Olshanski, *The two-sided infinite extension of the Mallows model for random permutations*, Advances in Applied Mathematics 48 (2012), no. 5, 615–639, arXiv:1103.1498.
- [7] C. L. Mallows, *Non-null ranking models. I*, Biometrika 44 (1957), 114–130.

## Spread of a rumor via a Lipschitz surface on percolation

PETER GRACAR

(joint work with Alexandre Stauffer)

Start with a Poisson point process of particles on the  $d$ -dimensional square lattice  $\mathbb{Z}^d$ . Assume that there is an infected particle at the origin at time 0. The other particles are initially uninfected, but get infected whenever they occupy the same site as an infected particle. In [6] Kesten and Sidoravicius showed that although individual particles have no drift, the spread of the infection experiences a drift. In order to see this, we track a distinguished particle starting with the initially infected particle. Then, whenever the distinguished particle shares a site with other infected particles, with probability larger than  $\frac{1}{2d}$  at least one of the particles jumps in a given direction, thereby becoming the distinguished particle. In their proof, they develop an intricate multi-scale argument to show that having more than one particle at the same site as the distinguished particle happens often enough over time, hence establishing the positive speed of spread of the infection.

The challenge in this setup comes from the heavily dependent structure of the model. Though particles move independently of one another, dependencies do arise over time. For example, if a ball of radius  $R$  centered at some vertex  $x$  of the graph turns out to have no particles at time 0, then the ball  $B(x, R/2)$  of radius  $R/2$  centered at  $x$ , will continue to be empty of particles up to time  $R^2$ , with positive probability. This means that the probability that the  $(d+1)$ -dimensional, space-time cylinder  $B(x, R/2) \times [0, R^2]$  has no particle is at least  $\exp\{-cR^d\}$  for some constant  $c$ , which is just a stretched exponential in the volume of the cylinder. On the other hand, one expects that, after time  $t \gg R^2$ , the set of particles inside the ball will become “close” to stationarity.

Multi-scale constructions are often used to deal with this kind of dependences, such as in the case of interlacements [10], activated random walks [8] and other questions in the above interacting particle system [6, 7, 9]. The main downside of these approaches is that they are always tailored specifically to the problem at hand and can’t be easily modified or extended to related problems.

Our research focus has been to develop a general framework that is more applicable and robust than past results, allowing us to show several results with only minor changes.

## 1. LIPSCHITZ SURFACE AND MULTI-SCALE PERCOLATION

Consider again the  $d$ -dimensional square lattice  $\mathbb{Z}^d$  with a Poisson point process of particles at time 0, which move as independent simple random walks. Tessellate space (the square lattice) into cubes and time into intervals, and index the resulting pairs of cubes and intervals by  $(i, \tau) \in \mathbb{Z}^d \times \mathbb{Z}$ . Then, we show in [3] that, given a local event  $E(i, \tau)$  that depends only on the random walks inside the space-time cell  $(i, \tau)$  and whose probability of occurrence is close enough to 1, there exists a two-sided Lipschitz surface (see Figure 1 for an example in 3 dimensions) of space-time cells where this event holds. Furthermore, we give the tail probability for the height of this surface at a given point, as well as several geometric properties, including the fact that the surface separates the origin from infinity and that the surface gives several percolation properties for the cells in it.

For an illustration of the applicability of this result to the spread of infection problem, define  $E(i, \tau)$  to be the event that if there is an infected particle in the cube indexed by  $i$  at the beginning of the time interval indexed by  $\tau$ , this particle first infects a large number of other particles, which then in turn move to the neighboring cubes by the end of the time interval  $\tau$ . Then, we have that once the infection reaches the surface (which happens a.s. in finite time since the surface separates the origin from infinity), the infection spreads throughout the cells of the surface. As a consequence, we obtain that the infection spreads with positive speed through the surface.

This result is robust in the sense that it holds for any  $d \geq 2$  and it can be easily modified to show positive speed of infection also for the case of infection with recovery. Furthermore, we show in [3] that the Lipschitz surface exists also when the square lattice is equipped with *uniformly elliptic conductances* (non-negative weights on the edges) and the particles jump to nearest-neighbors with probability proportional to these conductances.

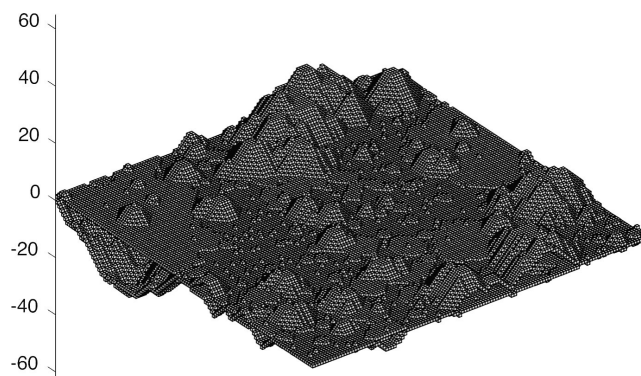

FIGURE 1. Two-sided Lipschitz surface on  $\mathbb{Z}^3$

## 2. MIXING OF PARTICLES ON A CONDUCTANCE GRAPH

A key challenge of the framework is to control the dependences that arise over time. We do this via a local mixing argument, which is the main result of [4]. Consider a cube  $Q_K$  of side-length  $K$  and a time interval of length  $\Delta$ . If the particles are spread around the cube in a sufficiently nice manner, one can quickly recover a stationary Poisson point process in the core of the cube. More precisely, let  $\mu_{x,y}$  be the conductance over the edge  $(x, y)$ , and let  $\mu_x = \sum_{y \sim x} \mu_{x,y}$  be the intensity of

the Poisson point process of particles at  $x$ . Fix  $\epsilon \in (0, 1)$  and tessellate the cube  $Q_K$  into subcubes  $(T_i)_i$  of side length  $\ell < K$ . Then, if each subcube  $T_i$  contains at least  $\lambda_0 \sum_{y \in T_i} \mu_y$  particles for some constant  $\lambda_0$ , and if  $\Delta \geq c\ell^2\epsilon^{-c}$ , the particles inside  $Q_K$  that are at least  $c\ell$  away from the boundary of  $Q_K$  stochastically dominate a Poisson point process of intensity measure  $\lambda_0(1-\epsilon)\mu_x$ . This occurs with probability at least

$$1 - \sum_{y \in Q_K} \exp\{-C\lambda_0\mu_y\epsilon^2\Delta^{d/2}\}.$$

Since particles inside the subcubes  $T_i$  can be distributed in an arbitrary fashion, this allows us to recover independence after letting particles move for large enough time. We do this by showing that such a local mixing result can be achieved whenever the conductances allow us to obtain the so-called *Parabolic Harnack Inequality*, as derived for example in [1, 2].

### 3. FURTHER DIRECTIONS AND MOTIVATION

In [4], we already show that using the local mixing result and the Lipschitz surface from [3] we can prove a positive speed result also for the case of infection with recovery. It is also easy to do a similar construction if we replace the graph  $G$  with an environment where a LCLT holds, such as the case of Brownian motions on  $\mathbb{R}^d$ .

It is however not clear if the Lipschitz surface construction can be applied to percolation clusters or other non-uniformly elliptic settings. The main problem is that there will be regions in space (regardless of time) which are atypically bad for whatever event one wishes to consider. This causes that region to be bad at *all* times, producing a percolation setting with infinite dependences. A specific example of this was studied in [5] for cylinders' percolation. Additionally, one could look at whether the approach works for random environments that change over time.

### REFERENCES

- [1] Martin T. Barlow. Random walks on supercritical percolation clusters. *Annals of Probability*, 32(4):3024–3084, 2004.
- [2] Martin T. Barlow and Ben M. Hambly. Parabolic Harnack inequality and local limit theorem for percolation clusters. *Electronic Journal of Probability*, 14:1–26, 2009.
- [3] Peter Gracar and Alexandre Stauffer. Multi-scale Lipschitz percolation of increasing events for Poisson random walks. *arXiv*, 2017.
- [4] Peter Gracar and Alexandre Stauffer. Random walks in random conductances: decoupling and spread of infection. *arXiv*, 2017.
- [5] Marcelo Hilário, Vladas Sidoravicius, and Augusto Teixeira. Cylinders' percolation in three dimensions. *Probability Theory and Related Fields*, 163(3-4):613–642, dec 2015.
- [6] Harry Kesten and Vladas Sidoravicius. The spread of a rumor or infection in a moving population. *Annals of Probability*, 33(6):2402–2462, 2005.
- [7] Harry Kesten and Vladas Sidoravicius. A shape theorem for the spread of an infection. *Annals of Mathematics*, 167(3):701–766, 2008.



- [8] Vladas Sidoravicius and Augusto Teixeira. Absorbing-state transition for Stochastic Sand-piles and Activated Random Walks. *arXiv*, 2014.
- [9] Alexandre Stauffer. Space-time percolation and detection by mobile nodes. *Annals of Applied Probability*, 25(5):2416–2461, 2015.
- [10] Alain-Sol Sznitman. Vacant Set of Random Interacements and Percolation. *Annals of Mathematics*, 171:2039–2087, 2010.

## Singular scaling limits in a planar random growth model

AMANDA TURNER

(joint work with Alan Sola, Fredrik Viklund)

Planar random growth processes occur widely in the physical world. Examples include diffusion-limited aggregation (DLA) for mineral deposition and the Eden model for biological cell growth. One of the curious features of these models is that although the models are constructed in an isotropic way, scaling limits appear to be anisotropic. In this talk, we construct a family of models in which randomly growing clusters can be represented as compositions of conformal mappings. We are able to show rigorously that for certain parameter choices, the scaling limits are anisotropic and we obtain shape theorems in this case. This contrasts with earlier work on related growth models in which the scaling limits are shown to be growing disks [5, 2].

Clusters of particles can be represented using compositions of conformal mappings as follows. Let  $\mathbf{c} > 0$ , and let  $f_{\mathbf{c}}$  denote the unique conformal map

$$f_{\mathbf{c}}: \Delta = \{z \in \mathbb{C}: |z| > 1\} \rightarrow D_1 = \Delta \setminus (1, 1+d]$$

having  $f_{\mathbf{c}}(z) = e^{\mathbf{c}}z + \mathcal{O}(1)$  at infinity, and sending the exterior disk  $\Delta$  to the complement of the closed unit disk with a slit of length  $d = d(\mathbf{c})$  attached at the point 1. The capacity increment  $\mathbf{c}$  and the length  $d$  of the slit satisfy

$$(1) \quad e^{\mathbf{c}} = 1 + \frac{d^2}{4(1+d)};$$

in particular,  $d \asymp \mathbf{c}^{1/2}$  as  $\mathbf{c} \rightarrow 0$ . In terms of aggregation, the closed unit disk can be viewed as a seed, while the slit represents an attached particle. Typically, we think of the particle as being small compared to the seed.

A general two-parameter framework to model random or deterministic aggregation, based on conformal maps, is given by the following construction. Pick a sequence  $\{\theta_k\}_{k=1}^{\infty}$  in  $[-\pi, \pi)$ , and let  $\{d_k\}_{k=1}^{\infty}$ , or, equivalently,  $\{c_k\}_{k=1}^{\infty}$ , be a sequence of non-negative numbers connected via (1). From the two numerical sequences  $\{\theta_k\}$  and  $\{c_k\}$ , we obtain a sequence  $\{f_k\}_{k=1}^{\infty}$  of rotated and rescaled conformal maps, referred to as building blocks, via

$$f_k(z) = e^{i\theta_k} f_{c_k}(e^{-i\theta_k} z).$$

Finally, we set

$$(2) \quad \Phi_n(z) = f_1 \circ \cdots \circ f_n(z), \quad n = 1, 2, \dots$$

Each  $\Phi_n$  is itself a conformal map sending the exterior disk onto the complement of a compact set  $K_n \subset \mathbb{C}$ , that is,

$$\Phi_n: \Delta \rightarrow \mathbb{C} \setminus K_n.$$

The sets  $\{K_n\}_{n=1}^\infty$  are called clusters. They satisfy  $K_{n-1} \subset K_n$ , and model a growing two-dimensional aggregate formed of  $n$  particles.

We introduce the Aggregate Loewner evolution model, abbreviated ALE( $\alpha, \eta$ ), with parameters  $\alpha \in \mathbb{R}$  and  $\eta \in \mathbb{R}$ . In ALE( $\alpha, \eta$ ), conformal maps  $\Phi_n$  are defined as in (2) as follows. Let  $\theta_1$  be uniform in  $[0, 2\pi)$ , and, for  $k = 2, 3, \dots$ , let

$$\theta_k \propto \frac{|\Phi'_{k-1}(e^{\sigma+i\theta})|^{-\eta} d\theta}{\int_{\mathbb{T}} |\Phi'_{k-1}(e^{\sigma+it})|^\eta dt}.$$

Here,  $\sigma > 0$  is a regularization parameter, which ensures that the angle distributions are well defined even though  $\Phi'_{k-1}$  has zeros and singularities on  $\mathbb{T}$ . The parameter  $\sigma$  is allowed to depend on the basic capacity parameter  $\mathbf{c}$ .

Next, we define a sequence of capacity increments for  $k = 2, 3, \dots$  by taking

$$c_k = \frac{\mathbf{c}}{|\Phi'_{k-1}(e^{\tilde{\sigma}+i\theta_k})|^{\alpha/2}}$$

where  $\tilde{\sigma}$  is another regularization parameter. The ALE( $\alpha, 0$ ) model (with  $\tilde{\sigma} = 0$ ) is the same model as the Hastings-Levitov HL( $\alpha$ ) model [1], and in particular ALE(0, 0) coincides with the HL(0) model studied in depth in [5]. When  $\alpha = 2$ , the model coincides with the dielectric breakdown model (DBM) of Mathiesen and Jensen [4]. When  $\alpha = 0$ , the growth process is reminiscent of the Quantum Loewner Evolution (QLE) of Miller and Sheffield [3] but without quantum gravity, that is, with  $\gamma = 0$ , and with SLE curves replaced by straight slits.

Clusters that are formed by successively composing slit maps come with a natural notion of ancestry for their constituent particles. We say that a particle  $j$  has parent 0 if it attaches directly to the unit disk. We say that the particle  $j$  has parent  $k$  if the  $j^{\text{th}}$  particle is directly attached to the  $k^{\text{th}}$  particle. In the ALE(0,  $\eta$ ) model, each successive particle chooses its attachment point on the cluster according to the relative density of harmonic measure (as seen from infinity) raised to the power  $\eta$ . As the highest concentration of harmonic measure occurs at the tips of slits, intuitively one would expect that for sufficiently large values of  $\eta$  each particle is likely to attach near the tip of the previous particle. We show that this indeed happens, and we identify the values of  $\eta$  for which the above event occurs with high probability in the limit as  $\mathbf{c} \rightarrow 0$ . Figure 1 displays ALE(0,  $\eta$ ) clusters for different values of  $\eta$ .

Define the event

$$\Omega_N = \{\text{Particle } j \text{ has parent } j-1 \text{ for all } j = 1, \dots, N\}$$

in which there is a simple ancestral line whereby each particle is attached to the previous particle. Set  $n(t) = \lfloor t\mathbf{c}^{-1} \rfloor$ . Our main result states that if  $N = n(T)$  for

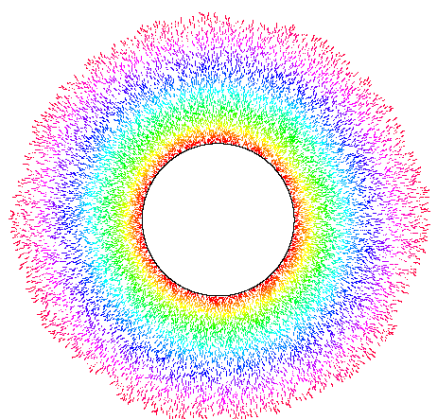

(a) ALE(-1.0)

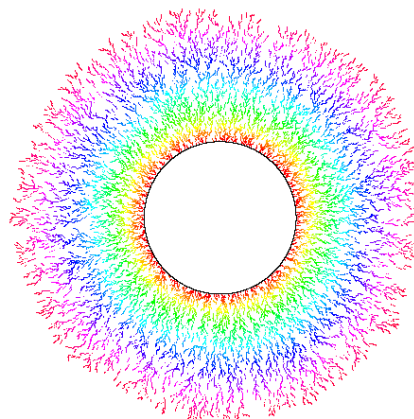

(b) ALE(0.0)

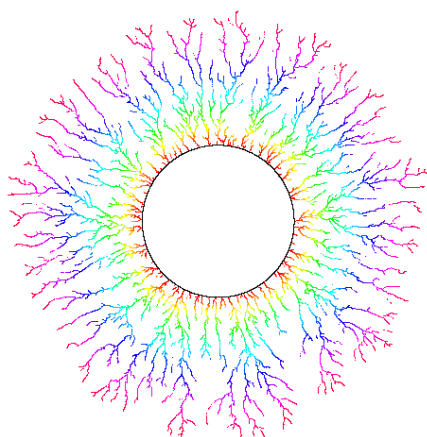

(c) ALE(1.0)

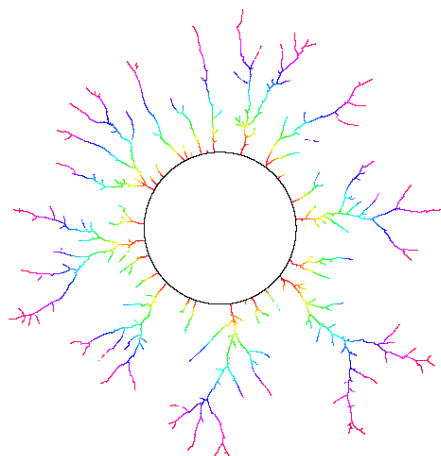

(d) ALE(1.5)

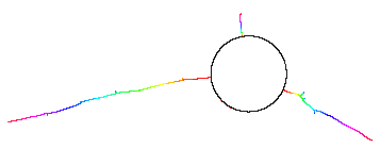

(e) ALE(2.0)

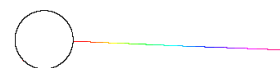

(f) ALE(4.0)

FIGURE 1. ALE clusters with  $\mathbf{c} = 10^{-4}$ ,  $\boldsymbol{\sigma} = \mathbf{c}^2$ , and  $n = 10,000$ .

some fixed  $T > 0$ , then

$$\begin{aligned} \lim_{\mathbf{c} \rightarrow 0} \mathbb{P}(\Omega_N) &= 1 && \text{if } \eta > 1 \\ \limsup_{\mathbf{c} \rightarrow 0} \mathbb{P}(\Omega_N) &< 1 && \text{if } \eta = 1, \end{aligned}$$

provided  $\sigma$  is small enough. When  $\eta > 1$ , we characterise how fast one must let  $\sigma \rightarrow 0$  as  $\mathbf{c} \rightarrow 0$  in order for  $\mathbb{P}(\Omega_N) \rightarrow 1$ . We show that when this happens, the cluster  $K_{n(t)}$  converges in the Hausdorff topology to a slit of capacity  $t$  at position  $e^{i\theta_1}$ .

#### REFERENCES

- [1] M. Hastings and L. Levitov, *Laplacian growth as one-dimensional turbulence*, Phys. D **116** (1998), 244–252.
- [2] F. Johansson Viklund, A. Sola, and A. Turner, *Small-particle limits in a regularized Laplacian random growth model*, Comm. Math. Phys. **334** (2015), 331–366.
- [3] J. Miller and S. Sheffield, *Quantum Loewner evolution*, Duke Math. J. **165** (2016), 3241–3378.
- [4] J. Mathiesen and M. Jensen, *Tip Splittings and Phase Transitions in the Dielectric Break-down Model*, Phys. Rev. Lett. **88** (2002), 235505.
- [5] J. Norris and A. Turner, *Hastings-Levitov aggregation in the small-particle limit*, Comm. Math. Phys. **316** (2012), 809–841.

### Quenched CLT for random walk in doubly stochastic random environment

BÁLINT TÓTH

Let  $(\Omega, \mathcal{F}, \pi, \tau_z : z \in \mathbb{Z}^d)$  be a probability space with an ergodic  $\mathbb{Z}^d$ -action. Denote by  $\mathcal{E} := \{k \in \mathbb{Z}^d : |k| = 1\}$  the set of possible steps of a nearest-neighbour walk on  $\mathbb{Z}^d$ , and let  $p_k : \Omega \rightarrow [0, s^*]$ ,  $k \in \mathcal{E}$ , be bounded measurable functions. These will be the jump rates of the RWRE considered (see (2) below) and assume they are *doubly stochastic*,

$$(1) \quad \sum_{k \in \mathcal{E}} p_k(\omega) = \sum_{k \in \mathcal{E}} p_{-k}(\tau_k \omega).$$

Given these, define the continuous time nearest neighbour random walk  $t \mapsto X(t) \in \mathbb{Z}^d$  as a Markov process on  $\mathbb{Z}^d$ , with  $X(0) = 0$  and conditional jump rates

$$(2) \quad \mathbf{P}_\omega (X(t + dt) = x + k \mid X(t) = x) = p_k(\tau_x \omega) dt,$$

where the subscript  $\omega$  denotes that the random walk  $X(t)$  is a Markov process on  $\mathbb{Z}^d$  *conditionally*, with fixed  $\omega \in \Omega$ , sampled according to  $\pi$ .  $\mathbf{P}_\omega(\cdot)$ , respectively,  $\mathbf{P}(\cdot) := \int_\Omega \mathbf{P}_\omega(\cdot) d\pi(\omega)$  will denote quenched, respectively, annealed probability. Due to double stochasticity (1) the annealed set-up is stationary and ergodic in time: the process of the environment as seen from the position of the random walker

$$(3) \quad \eta(t) := \tau_{X(t)} \omega$$

is a stationary and ergodic Markov process on  $(\Omega, \pi)$  and, consequently, the random walk  $t \mapsto X(t)$  will have stationary and ergodic annealed increments.

The local *quenched* drift of the random walk is

$$(4) \quad \mathbf{E}_\omega (dX(t) \mid X(t) = x) = \sum_{k \in \mathcal{E}} k p_k(\tau_x \omega) dt =: \varphi(\tau_x \omega) dt.$$

Beside double stochasticity (1) we assume that the jump rates are uniformly elliptic (5) and the walk doesn't have an overall drift (6):

$$(5) \quad s_k(\omega) \geq s_*, \quad \pi\text{-a.s.},$$

$$(6) \quad \int_{\Omega} v_k(\omega) d\pi(\omega) = 0.$$

Note that the bistochasticity condition (1) is equivalent to assuming that the local drift field (4) is divergence-free. The notorious  $\mathcal{H}_{-1}$ -condition plays a key role in diffusive scaling limits. Denote for  $i, j = 1, \dots, d, x \in \mathbb{Z}^d, p \in [-\pi, \pi)^d$ ,

$$(7) \quad C_{ij}(x) := \int_{\Omega} \varphi_i(\omega) \varphi_j(\tau_x \omega) d\pi(\omega), \quad \widehat{C}_{ij}(p) := \sum_{x \in \mathbb{Z}^d} e^{\sqrt{-1}x \cdot p} C_{ij}(x).$$

The  $\mathcal{H}_{-1}$ -condition is the following:

$$(8) \quad \int_{[-\pi, \pi)^d} \left( \sum_{j=1}^d (1 - \cos p_j) \right)^{-1} \sum_{i=1}^d \widehat{C}_{ii}(p) dp < \infty.$$

This is an *infrared bound* on the correlations of the drift field,  $x \mapsto \varphi(\tau_x \omega) \in \mathbb{R}^d$ . It implies diffusive upper bound on the annealed variance of the walk and turns out to be a natural sufficient condition for the diffusive scaling limit (that is, CLT for the annealed walk).

The main result of [6] is the following central limit theorem for the displacement of the random walker – valid in probability with respect to the environment distribution.

**Theorem 1.** *Conditions (1), (5), (8) are assumed. The asymptotic annealed covariance matrix*

$$(9) \quad (\sigma^2)_{ij} := \lim_{t \rightarrow \infty} t^{-1} \mathbf{E} (X_i(t) X_j(t))$$

*exists, and it is finite and non-degenerate. For any bounded and continuous function  $f : \mathbb{R}^d \rightarrow \mathbb{R}$ ,*

$$(10) \quad \lim_{T \rightarrow \infty} \int_{\Omega} \left| \mathbf{E}_\omega \left( f(T^{-1/2} X(T)) \right) - \int_{\mathbb{R}^d} \frac{e^{-|y|^2/2}}{(2\pi)^{d/2}} f(\sigma^{-1} y) dy \right| d\pi(\omega) = 0.$$

Weak convergence in the sense of (10) of all finite dimensional marginal distributions of  $t \mapsto T^{-1/2} X(Tt)$ , as  $T \rightarrow \infty$ , to those of a  $d$ -dimensional Brownian motion with covariance  $\sigma^2$  is established. The proof is based on a martingale approximation a la Kipnis-Varadhan. However, the various well-established sector

conditions do not apply. We rely on the functional-analytic technique, worked out in [2], proving that the *formally defined operator*

$$(11) \quad B := (L + L^*)^{-1/2} (L - L^*) (L + L^*)^{-1/2},$$

where  $L$  is the infinitesimal generator of the environment process (3), does make sense as a proper, densely defined and closed skew-self-adjoint operator, on the Hilbert space  $\mathcal{L}^2(\Omega, \pi)$ .

The  $\mathcal{H}_{-1}$ -condition (8) is equivalent to square stationarity and integrability of the stream tensor which defines – defined terms of Helmholtz’s theorem – by the divergence-free drift-field. Assuming slightly stronger integrability condition –  $\mathcal{L}^{2+\varepsilon}$  rather than merely  $\mathcal{L}^2$  – on the stream tensor, in [9] we prove the following *quenched CLT*. See [6], [9], [10] for its precise details.

**Theorem 2.** *Conditions (1), (5), (8), and the stronger integrability condition hinted at are assumed. For any bounded continuous function  $f : \mathbb{R}^d \rightarrow \mathbb{R}$ ,*

$$\lim_{T \rightarrow \infty} \mathbf{E}_\omega \left( f(T^{-1/2} X(T)) \right) = \int_{\mathbb{R}^d} \frac{e^{-\frac{|y|^2}{2}}}{(2\pi)^{\frac{d}{2}}} f(\sigma^{-1} y) dy, \quad \pi\text{-a.s.}$$

*with the non-degenerate covariance matrix  $\sigma^2$  given in (9).*

As in the case of Theorem 1, the weak convergence of all finite dimensional distributions follows. The proof consists of three major steps:

- (1) Proof of *quenched tightness* of the scaled displacement  $t^{-1/2} X(t)$ , as  $t \rightarrow \infty$ . This step relies on an extension of Nash’s celebrated moment bounds to non-selfadjoint context with unbounded coefficients
- (2) Construction of the *harmonic coordinates* for the walk. This is done by solving an equation in  $\mathcal{L}^2(\Omega, \pi)$ , relying on the functional analytic details of (11) in [6].
- (3) Efficient estimate of the discrepancy between the actual position of the walker and the approximating harmonic coordinates.

For detailed background and context of these results see the historical comments in [3] and [10]. Here we only mention that the problem and some of the main ideas date back to the ground-breaking works (listed in chronological order) [4], [8], [7], [5]. Various versions of the CLT-s in Theorems 1, 2 under much stronger conditions have been earlier established: In [1] quenched CLT is proved under the condition of  $\mathcal{L}^\infty$  stream tensor. In [3] annealed CLT is proved assuming  $\mathcal{L}^{\max\{2+\varepsilon, d\}}$  stream tensor.

## REFERENCES

- [1] J-D. Deuschel, H. Kösters: The quenched invariance principle for random walks in random environments admitting a bounded cycle representation. *Ann. Inst. H. Poincaré – Probab. et Stat.* **44**: 574-591 (2008)
- [2] I. Horváth, B. Tóth, B. Vető: Relaxed sector condition. *Bull. Inst. Math. Acad. Sin. (N.S.)* **7**: 463-476 (2012)

- [3] T. Komorowski, C. Landim, S. Olla: *Fluctuations in Markov Processes — Time Symmetry and Martingale Approximation. Grundlehren der mathematischen Wissenschaften*, Vol. 345, Springer, 2012
- [4] S.M. Kozlov: The averaging of random operators. *Mat. Sb. (N.S.)* **109**: 188-202 (1979)
- [5] S.M. Kozlov: The method of averaging and walks in inhomogeneous environments. *Uspekhi Mat. Nauk* **40**: 61-120 (1985)
- [6] G. Kozma, B. Tóth: Central limit theorem for random walks in doubly stochastic random environment:  $\mathcal{H}_{-1}$  suffices. *Ann. Probab.* **45**: 4307-4347 (2017)
- [7] H. Osada: Homogenization of diffusion processes with random stationary coefficients. *Lecture Notes in Mathematics* **1021**: 507-517, Springer, Berlin (1983)
- [8] G.C. Papanicolaou, S.R.S. Varadhan: Boundary value problems with rapidly oscillating random coefficients. In: J. Fritz, D. Szász, J.L. Lebowitz, (eds.): *Random Fields (Esztergom, 1979)*. *Colloq. Math. Soc. János Bolyai* **27**: 835-873, North-Holland, Amsterdam (1981)
- [9] B. Tóth: Quenched central limit theorem for random walks in doubly stochastic random environment. *Ann. Probab.* **46**: (2018, to appear) [arXiv:1704.06072](https://arxiv.org/abs/1704.06072)
- [10] B. Tóth: Diffusive and Super-Diffusive Limits for Random Walks and Diffusions with Long Memory. *Proceedings of the International Congress of Mathematicians, 2018 - Rio de Janeiro*, (to be published)

## Eigenvector correlations in the complex Ginibre ensemble

NICK CRAWFORD

(joint work with Ron Rosenthal)

For  $N \in \mathbb{N}$ , let  $M_N = (M_{ij})_{i,j=1}^N$  denote a random  $N \times N$  matrix chosen according to the Ginibre ensemble. That is,  $M_N$  is an  $N \times N$  matrix with complex entries  $M_{ij}$ , where  $(M_{ij})_{i,j \geq 1}$  are independent complex Gaussian random variables with mean 0 and variance  $1/N$ . Let us denote the probability measure of such a complex Gaussian variable by  $\kappa_N$

$$\kappa_N(dz) = \pi^{-1} \exp(-N|z|^2) N d^2z, \quad \forall z \in \mathbb{C},$$

and by  $\mathbb{P}$  the joint law of the random variables  $(M_{ij})_{i,j \geq 1}$ .

With  $\mathbb{P}$ -probability 1, the matrix  $M_N$  is diagonalizable and has  $N$  distinct eigenvalues, denoted  $(\lambda_i)_{i=1}^N$ . The statistical behavior of eigenvalues is well understood in the more general setting of non-Hermitian random matrices with i.i.d. complex entries under modest analytic assumptions on the distribution of entries: The spectrum (and the  $k$ -point distribution) of  $M_N$  converges in  $\mathbb{P}$ -probability (and also almost surely), in the limit  $N \rightarrow \infty$ , to the uniform measure on the unit disc  $\mathbf{D}_1 := \{z \in \mathbb{C} : |z| < 1\} \subset \mathbb{C}$  (resp.  $\mathbf{D}_1^k$ ), see [8, 9, 1, 21, 19, 12].

Since the matrix  $M_N$  is generically non-Hermitian with respect to the natural inner product on  $\mathbb{C}^N$ , one can associate to  $(\lambda_i)_{i=1}^N$  two sets of bases of eigenvectors for  $\mathbb{C}^N$ , a basis of ‘right’ eigenvectors  $(\mathbf{r}_i)_{i=1}^N$  and a basis of ‘left’ eigenvectors  $(\mathbf{l}_i)_{i=1}^N$ . In the natural coordinate system defining  $M_N$ , the  $\mathbf{r}_i$ ’s are column vectors and  $M_N \mathbf{r}_i = \lambda_i \mathbf{r}_i$  while the  $\mathbf{l}_i$ ’s are row vectors and  $\mathbf{l}_i M_N = \lambda_i \mathbf{l}_i$ . Given the  $\mathbf{r}_i$ ’s, the  $\mathbf{l}_i$ ’s are defined uniquely by the normalizations

$$(1) \quad \mathbf{l}_i \cdot \mathbf{r}_j = \delta_{ij},$$

Unlike what transpires in the Hermitian setting, the eigenvectors  $\mathbf{r}_i$  are strongly correlated with the eigenvalues  $\lambda_i$ . This has a number of interesting consequences. For example, there is no simple description for the analogue of Dyson’s Brownian motion of the Ginibre ensemble, since one has to track the evolution of both eigenvalues and eigenvectors.

In this talk, we report on recent inquiries into the *geometry* of the eigenbases  $(\mathbf{r}_i)_{i=1}^N$  and  $(\mathbf{l}_i)_{i=1}^N$ . We shall provide further motivation for this below but, for now, let us simply say that we find related questions intrinsically interesting: What are the typical angles between distinct eigenvectors? What is the volume of the parallelepiped determined by the eigenvectors corresponding to eigenvalues near the deterministic parameters  $\nu_1, \dots, \nu_\ell$  for some fixed  $\ell \in \mathbb{N}$  as  $N \rightarrow \infty$ ? How does the minimal angle between eigenvectors behave as a function of  $N$ ?

For a finite set  $A \subset \mathbb{N}$  denote by  $\mathcal{S}_A$  the permutation group on  $A$ , and define  $\mathbb{S} = \bigsqcup_{A \subset \mathbb{N} | A| < \infty} \mathcal{S}_A$ . Here,  $\bigsqcup$  denote the *disjoint* union of these collections of permutations. That is, in this definition we do not identify permutations which have the same fixed points, so the cycle  $(1, 2, 3) \in \mathcal{S}_{[3]}$  is not the same as  $(1, 2, 3)(4) \in \mathcal{S}_{[4]}$ . For  $\sigma \in \mathbb{S}$  we denote by  $\mathcal{V}(\sigma)$  the set of vertices in its domain (its length) and by  $|\sigma|$  the number of cyclic permutation it is composed of.

For  $\sigma \in \mathbb{S}$ , let  $\mathcal{I}_\sigma = \mathcal{I}_\sigma^N$  be the collection of tuples indexed by  $\mathcal{V}(\sigma)$  and taking values in  $\mathbb{N}$ . Then for  $\sigma \in \mathbb{S}$  and  $\mathbf{u}, \mathbf{v} \in \mathbf{D}_1^{\mathcal{V}(\sigma)}$ , set

$$(2) \quad \hat{\rho}_{N,\varepsilon}(\sigma; \mathbf{u}, \mathbf{v}) := \varepsilon^{-4|\mathcal{V}(\sigma)|} N^{-|\sigma|} \sum_{I, J \in \mathcal{I}_\sigma} \phi_\varepsilon(\|\mathbf{u} - \lambda_I\|_\infty) \phi_\varepsilon(\|\mathbf{v} - \lambda_J\|_\infty) \times \prod_{j \in \mathcal{V}(\sigma)} (\mathbf{l}_{J_{\sigma^{-1}(j)}} \cdot \mathbf{l}_{I_j}^\dagger)(\mathbf{r}_{I_j}^\dagger \cdot \mathbf{r}_{J_j}),$$

For  $m \in \mathbb{N}$  and  $\mathbf{u}, \mathbf{v} \in \mathbf{D}_1^m$  define

$$\begin{aligned} \text{Dist}(\mathbf{u}, \mathbf{v}) &= \text{Dist}(\mathbf{u}, \mathbf{v}; \partial \mathbf{D}_1) \\ &:= \min_{\alpha, \beta \in [m]} \{|u_\alpha - v_\beta|\} \wedge \min_{\alpha, \beta \in [m], \alpha \neq \beta} \{|u_\alpha - u_\beta|, |v_\alpha - v_\beta|\} \\ &\quad \wedge \min_{\alpha \in [m]} \{1 - |u_\alpha|, 1 - |v_\alpha|\}. \end{aligned}$$

Our first theorem is a factorization of this correlation function over the loops of  $\sigma$  in the macroscopic scale of separation.

**Theorem 1.** *For every  $\sigma \in \mathbb{S}$  and every  $\mathbf{u}, \mathbf{v} \in \mathbf{D}_1^{\mathcal{V}(\sigma)}$  such that  $\text{Dist}(\mathbf{u}, \mathbf{v}) > 0$ , the limit  $\rho(\sigma; \mathbf{u}, \mathbf{v})$  exists. Moreover, if  $\sigma = \{\mathcal{L}_k\}_{k=1}^r$  where  $\mathcal{L}_k$  are the cycles of  $\sigma$ , then*

$$\rho(\sigma; \mathbf{u}, \mathbf{v}) = \prod_{k=1}^r \rho(\mathcal{L}_k; \mathbf{u}|_{\mathcal{V}(\mathcal{L}_k)}, \mathbf{v}|_{\mathcal{V}(\mathcal{L}_k)}).$$

The case  $\ell = 1$  was previously computed by Chalker and Mehlige [4], for which they obtained the beautiful formula

$$\rho_2(\nu_1, \nu_2) = -\frac{1 - \nu_1 \bar{\nu}_2}{|\nu_1 - \nu_2|^4}.$$



Chalker and Mehlig were motivated to compute this formula after considering the following problem. Let  $M_N$  and  $M'_N$  be a pair of independent random matrices distributed according to the Ginibre ensemble and interpolate from one to the other via  $M_N(\theta) = \cos(\theta)M_N + \sin(\theta)M'_N$ . How do the eigenvalues  $\lambda_i(\theta)$  vary with  $\theta$ ? Note that for any fixed  $\theta$ , the matrix  $M_N(\theta)$  has the same distribution as  $M_N$ . However, examining the velocities of eigenvalues, Chalker and Mehlig found that  $\mathbb{E}[|\partial_\theta \lambda_i|^2] = 1 - \mathbb{E}[|\lambda_i|^2]$ . Here the length square of  $Q_i$  in the Hilbert-Schmidt norm naturally appears. It turns out that this length is asymptotic to  $N(1 - |\lambda_i|^2)$ . By way of comparison, for the (self adjoint) Gaussian Unitary Ensemble with the same normalization on the matrix entries, it is known that  $\mathbb{E}[\partial_\theta \lambda_i^2] = O(1/N)$ , see [26]. This indicates a strong instability in the spectrum of a non-Hermitian random matrix which cannot be captured by the typical studies of eigenvalues alone and provides substantial motivation for our work.

Another point of view one might take, which makes the quantities we study quite natural, is that Chalker and Mehlig computed the two point, or spin-spin, correlation function of some implicitly defined statistical mechanical system. As is well known, the eigenvalues of the Ginibre ensemble form a system of free fermions, or, equivalently, a determinantal point process. In this interpretation, the associated eigenvectors should not be forgotten as they provide an additional spin structure for this system of fermions.

Let us next discuss the asymptotic behavior of cycle correlation functions. For two cyclic loops  $\sigma, \tau \in \mathbb{S}$  such that  $\mathcal{V}(\sigma) \subset \mathcal{V}(\tau)$ , we say that  $\sigma$  is a sub-loop of  $\tau$  if the map  $\tau \circ \sigma^{-1}$  has at most one non-fixed point (as a map from  $\mathcal{V}(\sigma)$  to  $\mathcal{V}(\tau)$ ). Any permutation  $\tau \in \mathbb{S}$  induces an orientation on  $\mathcal{V}(\tau)$ . In particular, for  $m \geq 3$  and  $\alpha_1, \dots, \alpha_m \in \mathcal{V}(\tau)$  one can check whether  $(\alpha_1, \dots, \alpha_m)$  belong to the same cycle in  $\tau$  and appear on it with the prescribed ordering. Given two disjoint subloops  $\mathcal{L}_1$  and  $\mathcal{L}_2$  of a cyclic permutation  $\tau$ , we say that they are crossing if there exists  $\alpha \in \mathcal{V}(\mathcal{L}_1)$  and  $\beta \in \mathcal{V}(\mathcal{L}_2)$  such that  $(\alpha, \mathcal{L}_1(\alpha), \beta, \mathcal{L}_2(\beta))$  is not the ordering of those vertices in  $\tau$ . Otherwise we say that  $\mathcal{L}_1$  and  $\mathcal{L}_2$  are non-crossing. There is a natural partial ordering on permutations  $\preceq$  in  $\mathbb{S}$  defined as follows. For  $\sigma, \tau \in \mathbb{S}$ , say that  $\sigma \preceq \tau$  if  $\mathcal{V}(\sigma) \subset \mathcal{V}(\tau)$ , every loop of  $\sigma$  is a sub-loop of some loop in  $\tau$  and all pairs of loops of  $\sigma$  are non-crossing with respect to  $\tau$ .

Let  $V_A(\mathbf{v})$  be the Vandermonde determinant  $\prod_{\substack{\alpha, \beta \in A \\ \alpha < \beta}} (v_\beta - v_\alpha)$ .

**Theorem 2.** *There are two families of polynomials  $(\mathfrak{R}_\sigma, \mathfrak{L}_\sigma)_{\sigma \in \mathbb{S}}$  with  $\mathfrak{R}_\sigma$  and  $\mathfrak{L}_\sigma$  being polynomials in the variables  $\bar{\mathbf{u}}, \mathbf{w} \in \mathbf{D}_1^{\mathcal{V}(\sigma)}$  such that for every finite set  $A \subset \mathbb{N}$*

$$\rho(\mathcal{L}_A; \mathbf{u}, \mathbf{w}) = V_A(\bar{\mathbf{u}})^{-1} V_A(\mathbf{w})^{-1} \sum_{\mathbf{I}_A \preceq \sigma \preceq \mathcal{L}_A} \mathfrak{R}_\sigma \mathfrak{L}_\sigma \prod_{j \in A} \rho_2(\bar{u}_j, v_{\sigma^{-1}(j)}),$$

where  $\mathcal{L}_A$  is a cyclic permutation on  $A$ .

Hence as the notation of Theorem 2 suggests, in spite of the factorization stated in Theorem 1, the two results are deeply intertwined.

We finish this abstract by describing some structural properties the polynomials satisfy. To this end let us introduce a matrix  $\mathfrak{N}$ , indexed by the elements of  $\mathbb{S}$ , which plays a crucial role in our paper. For  $\sigma, \tau \in \mathbb{S}$  we say that  $\sigma \prec \tau$  if  $\mathcal{V}(\sigma) \subset \mathcal{V}(\tau)$ , every loop of  $\sigma$  is a subloop of  $\tau$  and all but at most one of the loops of  $\tau$  are also loops in  $\sigma$ . Notice that  $\sigma \prec \tau$  implies  $\sigma \preceq \tau$  but the converse is not necessarily true. Given  $\sigma, \tau \in \mathbb{S}$  such that  $\sigma \prec \tau$  define  $\widehat{\mathcal{V}}_{nf}(\tau \circ \sigma^{-1})$  to be the set of the *non-fixed points* of  $\tau \circ \sigma^{-1}$  union with the set of points in  $\mathcal{V}(\tau) \setminus \mathcal{V}(\sigma)$ .

Then we define the functions  $\mathbf{n} : \mathbb{S}^2 \times \mathbb{C}^2 \rightarrow \mathbb{C}$  and  $\mathbf{h} : \mathbb{S} \times \mathbb{C}^2 \rightarrow \mathbb{C}$  by

$$(3) \quad \mathbf{n}(\sigma, \tau; \mathbf{u}, \mathbf{v}) = \frac{1}{\pi} \int_{\mathbf{D}_1} \prod_{\alpha \in \widehat{\mathcal{V}}_{nf}(\tau \circ \sigma^{-1})} \frac{1}{(\bar{v} - \bar{u}_\alpha)} \frac{1}{(v - v_{\sigma^{-1}(\alpha)})} d^2\nu$$

and

$$(4) \quad \mathbf{h}(\sigma; \mathbf{u}, \mathbf{v}) = \sum_{\alpha \in \mathcal{V}(\sigma)} h(u_\alpha, v_{\sigma^{-1}(\alpha)}),$$

where for  $u, v \in \mathbf{D}_1$ , we define

$$h(u, v) = \frac{1}{\pi} \int_{\mathbf{D}_1} \frac{1}{(\bar{v} - \bar{u})(v - v)} d^2\nu = \log \left( \frac{1 - v\bar{u}}{|u - v|^2} \right).$$

Note that  $\partial_u \partial_{\bar{v}} h(u, v) = \rho_2(u, v)$ .

The matrix  $\mathfrak{N} \equiv \mathfrak{N}(\mathbf{u}, \mathbf{v})$  is then defined by

$$(5) \quad \mathfrak{N}_{\sigma, \tau} = \begin{cases} \mathbf{h}_\tau(\mathbf{u}, \mathbf{v}) & \text{if } \sigma = \tau \\ \mathbf{n}(\sigma, \tau; \mathbf{u}, \mathbf{v}) & \text{if } \sigma \prec \tau \\ 0 & \text{otherwise} \end{cases}.$$

Note that  $\mathfrak{N}$  is upper triangular since  $\preceq$  is a partial order  $\preceq$  and therefore its eigenvalues are the diagonal entries  $\mathbf{h}_\tau(\mathbf{u}, \mathbf{v})$ . The component equations for the eigenvectors of  $\mathfrak{N}$  can be written recursively. If  $\mathbf{l}_\pi$ , respectively  $\mathbf{r}_\pi$ , denote the left (respectively right) eigenvectors, then

$$(6) \quad [\mathbf{h}_\pi - \mathbf{h}_\tau] \mathbf{l}_\pi(\tau) = \sum_{\pi \preceq \sigma \prec \tau} \mathbf{l}_\pi(\sigma) \mathfrak{N}_{\sigma, \tau}, \quad \forall \pi, \tau \in \mathbb{S},$$

$$(7) \quad [\mathbf{h}_\tau - \mathbf{h}_\pi] \mathbf{r}_\tau(\pi) = \sum_{\pi \prec \sigma \preceq \tau} \mathfrak{N}_{\pi, \sigma} \mathbf{r}_\tau(\sigma), \quad \forall \pi, \tau \in \mathbb{S},$$

subject to the initial conditions  $\mathbf{l}_\pi(\pi) = \mathbf{r}_\pi(\pi) = 1$  for all  $\pi \in \mathbb{S}$ .

Our final result is then as follows.

**Theorem 3.** *The polynomials  $\mathfrak{R}, \mathfrak{L}$  appearing in Theorem 2 are respectively*

$$\mathfrak{R}_\sigma = \mathbf{V}_{\mathcal{V}(\sigma)}(\bar{\mathbf{u}}) \mathbf{V}_{\mathcal{V}(\sigma)}(\mathbf{v}) \mathbf{r}_\sigma(\emptyset), \quad \mathfrak{L}_\sigma = \mathbf{V}_{\mathcal{V}(\sigma)}(\bar{\mathbf{u}}) \mathbf{V}_{\mathcal{V}(\sigma)}(\mathbf{v}) \mathbf{l}_\sigma(\mathcal{L}_A).$$

Moreover, for all  $\sigma \preceq \tau$ , both  $\mathbf{V}_{\mathcal{V}(\sigma)}(\bar{\mathbf{u}}) \mathbf{V}_{\mathcal{V}(\sigma)}(\mathbf{v}) \mathbf{r}_\tau(\sigma)$  and  $\mathbf{V}_{\mathcal{V}(\sigma)}(\bar{\mathbf{u}}) \mathbf{V}_{\mathcal{V}(\sigma)}(\mathbf{v}) \mathbf{r}_\sigma(\tau)$  are polynomials in  $\bar{\mathbf{u}}, \mathbf{v}$  which vanish whenever  $(u_i, v_i) = (u_j, v_j)$  for  $i \neq j$ .

Further results exploring the properties of the polynomials  $(\mathfrak{R}_\sigma, \mathfrak{L}_\sigma)_{\sigma \in \mathbb{S}}$  and the algebraic/representation theoretic significance of them appear in [5, 6].

## REFERENCES

- [1] Z. D. Bai. Circular law. *Ann. Probab.*, 25(1):494–529, 01 1997.
- [2] P. Bourgade and G. Dubach. The distribution of overlaps between eigenvectors of Ginibre matrices. *ArXiv e-prints*, January 2018.
- [3] Zdzislaw Burda, Jacek Grela, Maciej A. Nowak, Wojciech Tarnowski, and Piotr Warchoł. Dysonian dynamics of the ginibre ensemble. *Phys. Rev. Lett.*, 113:104102, Sep 2014.
- [4] J. T. Chalker and B. Mehlige. Eigenvector statistics in non-hermitian random matrix ensembles. *Phys. Rev. Lett.*, 81:3367–3370, Oct 1998.
- [5] N. Crawford and R. Rosenthal. Eigenvector correlations for the ginibre ensemble. *In preparation*, 2018.
- [6] N. Crawford and R. Rosenthal. Local eigenvector correlations for the ginibre ensemble. *In preparation*, 2018.
- [7] Y. V Fyodorov. On statistics of bi-orthogonal eigenvectors in real and complex Ginibre ensembles: combining partial Schur decomposition with supersymmetry. *ArXiv e-prints*, October 2017.
- [8] Jean Ginibre. Statistical ensembles of complex, quaternion, and real matrices. *Journal of Mathematical Physics*, 6(3):440–449, 1965.
- [9] V.L. Girko. The circular law. *Teor. Veroyatnost. i Primenen.*, 29(4.):669?679, 1984.
- [10] Ilya Ya. Goldsheid and Boris A. Khoruzhenko. Distribution of eigenvalues in non-hermitian anderson models. *Phys. Rev. Lett.*, 80:2897–2900, Mar 1998.
- [11] Joseph F. Grcar. John von neumann’s analysis of gaussian elimination and the origins of modern numerical analysis. *SIAM Review*, 53(4):607–682, 2011.
- [12] Friedrich Gtze and Alexander Tikhomirov. The circular law for random matrices. *Ann. Probab.*, 38(4):1444–1491, 07 2010.
- [13] Naomichi Hatano and David R. Nelson. Localization transitions in non-hermitian quantum mechanics. *Phys. Rev. Lett.*, 77:570–573, Jul 1996.
- [14] Romuald A. Janik, Wolfgang Nörenberg, Maciej A. Nowak, Gábor Papp, and Ismail Zahed. Correlations of eigenvectors for non-hermitian random-matrix models. *Phys. Rev. E*, 60:2699–2705, Sep 1999.
- [15] Romuald A. Janik, Wolfgang Nörenberg, Maciej A. Nowak, Gábor Papp, and Ismail Zahed. Correlations of eigenvectors for non-hermitian random-matrix models. *Phys. Rev. E*, 60:2699–2705, Sep 1999.
- [16] B. Mehlige and J. T. Chalker. Statistical properties of eigenvectors in non-hermitian gaussian random matrix ensembles. *Journal of Mathematical Physics*, 41(5):3233–3256, 2000.
- [17] Madan Lal Mehta. *Random matrices*, volume 142. Academic press, 2004.
- [18] M. A. Nowak and W. Tarnowski. Probing non-orthogonality of eigenvectors in non-Hermitian matrix models: diagrammatic approach. *ArXiv e-prints*, January 2018.
- [19] Guangming Pan and Wang Zhou. Circular law, extreme singular values and potential theory. *Journal of Multivariate Analysis*, 101(3):645 – 656, 2010.
- [20] Richard P Stanley. *Enumerative combinatorics*. vol. 1, 1997.
- [21] Terence Tao and Van Vu. Random matrices: the circular law. *Communications in Contemporary Mathematics*, 10(02):261–307, 2008.
- [22] Lloyd Trefethen and M Embree. *Spectra and Pseudospectra: The behavior of nonnormal matrices and operators*. 01 2005.
- [23] Lloyd N. Trefethen. Pseudospectra of linear operators. *SIAM Review*, 39(3):383–406, 1997.
- [24] Lloyd N. Trefethen, Anne E. Trefethen, Satish C. Reddy, and Tobin A. Driscoll. Hydrodynamic stability without eigenvalues. *Science*, 261(5121):578–584, 1993.
- [25] Meg Walters and Shannon Starr. A note on mixed matrix moments for the complex ginibre ensemble. *Journal of Mathematical Physics*, 56(1):013301, 2015.
- [26] M Wilkinson. Statistics of multiple avoided crossings. *Journal of Physics A: Mathematical and General*, 22(14):2795, 1989.

## General Bootstrap Random Walks

ANDREA COLLEVECCHIO

(joint work with Kais Hamza, Yunxuan Liu, Meng Shi & Ruth Williams)

Consider a symmetric simple random walk  $X_n = \sum_{k=1}^n \xi_k$ ,  $X_0 = 0$ , where  $\xi_1, \xi_2, \dots$  are independent and identically distributed random variables with  $\mathbb{P}(\xi_1 = \pm 1) = 1/2$ . It is easy to see that the sequence  $\eta_n = \prod_{k=1}^n \xi_k$  is made up of independent and identically distributed random variables taking values  $\pm 1$  with equal probability, and that  $Y_n = \sum_{k=1}^n \eta_k$ ,  $Y_0 = 0$ , is also a symmetric simple random walk; that is

$$(1) \quad (Y_n)_{n \geq 0} \stackrel{d}{=} (X_n)_{n \geq 0}.$$

We refer to the process of constructing  $(Y_n)_n$  from  $(X_n)_n$  as bootstrapping.

While (1) is immediately clear, what may be less understood is the behaviour of the two-dimensional process  $W_n = (X_n, Y_n)$ .

In [2], we show that a suitably normalized process  $W$  converges weakly to a two-dimensional Brownian motion. Two extensions are also discussed: a generalization to the case of increments in a finite ‘‘alphabet’’ and to a multi-dimensional setting that highlight a connection with cellular automata. This is further generalized in [1] to the case of asymmetric simple random walks. Here, a suitably normalized bootstrap random walk converges to correlated multi-dimensional Brownian motion the covariance structure of which is given in an explicit way.

In this work we generalize this setting by only requiring that the ‘recycling’ be

- (1) law-preserving:  $(\eta_n)_{n \geq 0} \stackrel{d}{=} (\xi_n)_{n \geq 0}$ ;
- (2) non-anticipative:  $\eta_n$  is measurable with respect to  $\sigma(\xi_1, \dots, \xi_n)$ .

Let  $\mathfrak{X}_n(t) = \frac{1}{\sqrt{n}} X_{[nt]}$ ,  $\mathfrak{Y}_n(t) = \frac{1}{\sqrt{n}} Y_{[nt]}$  and  $\mathfrak{W}_n(t) = (\mathfrak{X}_n(t), \mathfrak{Y}_n(t))$ . We seek to characterize all possible limits of  $\mathfrak{W}_n$ .

We start by observing that the sequence  $\mathfrak{W}_n$  is tight. This follows from the basic fact that the product of 2 compact sets is compact. It follows that one can always extract a convergent subsequence. So, even when a limit does not exist, our objective is to identify all possible accumulation points. At this point in time, this question remains open. In the following we give partial answers.

### 1. GENERAL BOOTSTRAPPING

The first step is to identify all law-preserving and non-anticipative recyclings.

Let  $\mathbb{K}(n) = \mathcal{P}(\{1, \dots, n\})$  be the power set of  $\{1, \dots, n\}$ . For completeness, we let  $\mathbb{K}(0) = \{\emptyset\}$ . We also introduce the following notation for  $(x_1, \dots, x_n) \in \{-1, +1\}^n$ :

$$\text{for } K \in \mathbb{K}(n) \setminus \{\emptyset\}, x_{[K]} = \max_{k \in K} x_k \text{ and } x_{[\emptyset]} = -1.$$

**Theorem 1.** Let  $\eta_n = \phi_n(\xi_1, \dots, \xi_n)$ , then  $(\eta_n)_n \stackrel{d}{=} (\xi_n)_n$  if and only if for each  $n$  and each  $K \in \mathbb{K}(n-1)$ , there exists  $\beta_{n,K} \in \{0, 1\}$  such that

$$(2) \quad \phi_n(x_1, \dots, x_n) = \left( \prod_{K \in \mathbb{K}(n-1)} x_{[K]}^{\beta_{n,K}} \right) x_n.$$

Furthermore, for such functions

$$\phi_n(x_1, \dots, x_n) = \left( \frac{1}{2}(-1)^{|\mathcal{B}(n)|} - \frac{1}{2} \sum_{H \in \mathcal{P}(\mathcal{B}(n))} (-2)^{|H|} x_{\langle H \rangle} \right) x_n.$$

where  $\mathcal{B}(n) = \{K \in \mathbb{K}(n-1) : \beta_{n,K} = 1\}$  and for  $H = \{K_1, \dots, K_h\} \in \mathcal{P}(\mathcal{B}(n))$ ,  $\langle H \rangle = \bigcup_{j=1}^h K_j$ .

While these representations are not unique, they enable us to uncover sufficient (and in fact close to being necessary) conditions for the limit to be Brownian.

## 2. BROWNIAN LIMITS

In this section, we focus on cases when  $\mathfrak{W}_n$  converges weakly to a two-dimensional Brownian motion.

For any set of integers  $M$ , we let  $q(M) = \mathbb{P}(\xi_{[M]} = -1) = 2^{-|M|}$ .

**Theorem 2.** Suppose

$$(A) \quad \rho = \lim_{n \rightarrow \infty} \frac{1}{n} \sum_{k=1}^n \sum_{H \in \mathcal{P}(\mathcal{B}(k))} (-2)^{|H|} q(\langle H \rangle) \text{ exists};$$

$$(B) \quad \lim_{n \rightarrow \infty} \frac{1}{n^2} \sum_{\ell=1}^n \sum_{k=1}^n \sum_{\substack{K \in \mathcal{P}(\mathcal{B}(k)) \\ L \in \mathcal{P}(\mathcal{B}(\ell))}} (-2)^{|K|+|L|} q(\langle K \rangle \cup \langle L \rangle) = \rho^2.$$

Then  $\mathfrak{W}_n$  converges weakly to a two-dimensional Brownian motion (possibly degenerate) with correlation  $\rho$ .

**Corollary 3.** Suppose  $\eta_k = \left( \prod_{i=1}^m \xi_{[M_k^{(i)}]} \right) \xi_k$ , where  $M_k^{(i)} \in \mathbb{K}(k-1)$ , and

$$(A') \quad \text{for any } K \in \mathbb{K}(m), \gamma(K) = \lim_{n \rightarrow \infty} q \left( \bigcup_{i \in K} M_n^{(i)} \right) \text{ exists};$$

$$(B') \quad \lim_{n \rightarrow \infty} \frac{1}{n} \sum_{k=1}^n q \left( \left( \bigcup_{i=1}^m M_k^{(i)} \right) \cap \left( \bigcup_{i=1}^m M_{n+1}^{(i)} \right) \right) = 1.$$

Then  $\mathfrak{W}_n$  converges weakly to a two-dimensional Brownian motion (possibly degenerate) with correlation  $\sum_{K \in \mathbb{K}(m)} (-2)^{|K|} \gamma(K)$ .

**Corollary 4.** If for each  $i$ ,  $\sup_n |M_n^{(i)}| < +\infty$  and  $\limsup_n M_n^{(i)} = \emptyset$ , then (B') holds true.

We finish this section with a few examples.

- Example 5.** (1)  $\eta_n = \xi_n$ .  $\mathfrak{W}_n$  converges weakly to a degenerate two-dimensional Brownian motion ( $\rho = 1$ ).
- (2)  $\eta_n = \prod_{k=1}^n \xi_k$ .  $\mathfrak{W}_n$  converges weakly to an uncorrelated two-dimensional Brownian motion ( $\rho = 0$ ).
- (3)  $\eta_n = \xi_{n-1}\xi_n$ . In this case  $\xi_n = \prod_{k=1}^n \eta_k$  and the setting is identical to previous case.
- (4)  $\eta_n = \xi_{n-m} \dots \xi_{n-1}\xi_n$ , for  $m$  fixed.  $\mathfrak{W}_n$  converges weakly to an uncorrelated two-dimensional Brownian motion ( $\rho = 0$ ).
- (5)  $\eta_n = \max(\xi_{n-m} \dots \xi_{n-1})\xi_n$ , for  $m$  fixed.  $\mathfrak{W}_n$  converges weakly to a correlated two-dimensional Brownian motion ( $\rho = 1 - 2^{-m+1}$ ).

### 3. NON-BROWNIAN LIMITS

Are non-Brownian limits possible? The answer is yes and is given by the 'classical' example  $\eta_n = \text{sgn}(X_{n-1})\xi_n$ .

It is well-known that, for any bounded continuous  $f$ ,  $\int_0^t f(\mathfrak{X}_n(s-))d\mathfrak{X}_n(s)$  converges weakly to  $\int_0^t f(B_s)dB_s$ . Here, we adapt this result to the case  $f(x) = \text{sgn}(x)$  and show the following.

**Theorem 6.** For each  $t \geq 0$ ,  $\mathfrak{W}_n(t)$  converges weakly to  $(B_t, \int_0^t \text{sgn}(B_s)dB_s)$ , where  $B_t$  is a standard Brownian motion.

However, the two-dimensional process  $(B_t, \int_0^t \text{sgn}(B_s)dB_s)$  is not a Brownian motion as can be seen from computing the co-variation

$$(3) \quad \left\langle B, \int_0^\cdot \text{sgn}(B_s)dB_s \right\rangle_t = \int_0^t \text{sgn}(B_s)ds \neq t.$$

This result is further generalized to the case of a general symmetric function.

**Proposition 7.** A function  $\psi : \{-1, 1\}^n \rightarrow \{-1, 1\}$  is symmetric if and only if there exists a function  $\Psi_n$  such that

$$\psi(x_1, \dots, x_n) = \Psi_n(s_n),$$

where  $s_n = \sum_{k=1}^n x_k$ .

**Theorem 8.** Suppose, for  $\Psi : \mathbb{Z} \rightarrow \{-1, 1\}$ ,  $\eta_n = \Psi(X_{n-1})\xi_n$ . For each  $t \geq 0$ ,  $\mathfrak{W}_n(t)$  converges weakly to  $(B_t, \int_0^t \Psi(B_s)dB_s)$ ,

### REFERENCES

- [1] Collevocchio, A., Hamza, K. and Liu, Y., 2017. Invariance principle for biased bootstrap random walks. *arXiv preprint arXiv:1710.07920*.
- [2] Collevocchio, A., Hamza, K. and Shi, M., 2016. Bootstrap random walks. *Stochastic Processes and their Applications*, 126(6), pp.1744-1760.

Reporter: Julius Damarackas

## Participants

**Prof. Dr. Omer Angel**

Department of Mathematics  
University of British Columbia  
1984 Mathematics Road  
Vancouver BC V6T 1Z2  
CANADA

**Prof. Dr. Noam Berger**

Fakultät für Mathematik  
Technische Universität München  
85747 Garching bei München  
GERMANY

**Prof. Dr. Erwin Bolthausen**

Institut für Mathematik  
Universität Zürich  
Winterthurerstrasse 190  
8057 Zürich  
SWITZERLAND

**Prof. Dr. Elisabetta Candellero**

Statistics Institute  
University of Warwick  
Gibbet Hill Road  
Coventry CV4 7AL  
UNITED KINGDOM

**Prof. Dr. Pietro Caputo**

Dipartimento di Matematica  
Universita Roma III  
Largo S. Leonardo Murialdo 1  
00146 Roma  
ITALY

**Dr. Alessandra Caraceni**

Department of Mathematical Sciences  
University of Bath  
Claverton Down  
Bath BA2 7AY  
UNITED KINGDOM

**Dr. Alessandra Cipriani**

DIAM  
TU Delft  
Van Mourik Broekmanweg 6  
2628 XE Delft  
NETHERLANDS

**Prof. Dr. Andrea Collecchio**

School of Mathematical Sciences  
Monash University  
Clayton, Victoria 3800  
AUSTRALIA

**Dr. Nicholas J. Crawford**

Department of Mathematics  
Technion  
Israel Institute of Technology  
Haifa 32000  
ISRAEL

**Dr. Julius Damarackas**

Faculty of Mathematics and Informatics  
Vilnius University  
Naugarduko 24  
Vilnius 03225  
LITHUANIA

**Prof. Dr. Hugo Duminil-Copin**

Institut des Hautes Etudes Scientifiques  
(IHES), Le Bois-Marie  
35, route de Chartres  
91440 Bures-sur-Yvette  
FRANCE

**Dor Elboim**

Department of Mathematics  
School of Mathematical Sciences  
Tel Aviv University  
P.O.Box 39040  
Ramat Aviv, Tel Aviv 69978  
ISRAEL

**Prof. Dr. Alessandra Faggionato**

Dipartimento di Matematica  
Università di Roma "La Sapienza"  
Istituto "Guido Castelnuovo"  
Piazzale Aldo Moro, 2  
00185 Roma  
ITALY

**Prof. Dr. Alexander Glazman**

Department of Mathematics  
School of Mathematical Sciences  
Tel Aviv University  
P.O.Box 39040  
Ramat Aviv, Tel Aviv 69978  
ISRAEL

**Peter Gracar**

Department of Mathematical Sciences  
University of Bath  
Claverton Down  
Bath BA2 7AY  
UNITED KINGDOM

**Dr. Matan Harel**

IHES  
Institut des Hautes Études Scientifiques  
Le Bois-Marie  
35, route de Chartres  
91440 Bures-sur-Yvette  
FRANCE

**Dr. Tyler Helmuth**

Department of Mathematics  
University of Bristol  
University Walk  
Bristol BS8 1TW  
UNITED KINGDOM

**Prof. Marcelo R. Hilario**

Departamento de Matematica  
UFMG  
Avenida Antonio Carlos 6627  
C.P. 702  
Belo Horizonte, MG 30161-970  
BRAZIL

**Dr. Christoph Hofer-Temmel**

NLDA — FMW — CG MTW  
Enys House c/o KIM  
Het Nieuwe Diep 8  
1781 AC Den Helder  
NETHERLANDS

**Prof. Dr. Thomas Hutchcroft**

Trinity College  
Cambridge CB2 1TQ  
UNITED KINGDOM

**Prof. Dr. Dmitri Ioffe**

Faculty of Industrial Engineering  
and Management, TECHNION  
Israel Institute of Technology  
Haifa 32000  
ISRAEL

**Prof. Dr. Antal Jarai**

Department of Mathematical Sciences  
University of Bath  
Claverton Down  
Bath BA2 7AY  
UNITED KINGDOM

**Prof. Dr. Konstantin M. Khanin**

Department of Mathematics  
University of Toronto  
40 St. George Street  
Toronto ON M5S 2E4  
CANADA

**Prof. Dr. Daniel Kious**

Department of Mathematics  
NYU Shanghai  
1555 Century Avenue, Pudong Xinqu  
Shanghai Shi 200122  
CHINA



**Prof. Dr. Gady Kozma**

Faculty of Mathematics and Computer  
Science  
The Weizmann Institute of Science  
P.O. Box 26  
Rehovot 76100  
ISRAEL

**Dr. Hubert Lacoïn**

Instituto de Matematica Pura e Aplicada  
I M P A  
Jardim Botânico  
Estrada Dona Castorina, 110  
Rio de Janeiro, RJ 22460-320  
BRAZIL

**Andrea Lelli**

Department of Mathematical Sciences  
University of Bath  
Claverton Down  
Bath BA2 7AY  
UNITED KINGDOM

**Dr. Titus Lupu**

Departement Mathematik  
ETH-Zentrum  
Rämistrasse 101  
8092 Zürich  
SWITZERLAND

**Dr. Alexander Magazinov**

School of Mathematical Sciences  
Tel Aviv University  
P.O. Box 39040  
Tel Aviv 699 7801  
ISRAEL

**Prof. Dr. Ioan Manolescu**

Département de Mathématiques  
Université de Fribourg  
Perolles  
Chemin du Musée 23  
1700 Fribourg  
SWITZERLAND

**Prof. Dr. James B. Martin**

Department of Statistics  
University of Oxford  
1 South Parks Road  
Oxford OX1 3TG  
UNITED KINGDOM

**Dr. Fabio Martinelli**

Dipartimento di Matematica  
Universita Roma III  
Largo S. Leonardo Murialdo, 1  
00146 Roma  
ITALY

**Dr. Ron Peled**

Department of Mathematics  
School of Mathematical Sciences  
Tel Aviv University  
Ramat Aviv, Tel Aviv 69978  
ISRAEL

**Prof. Dr. Christophe Sabot**

Institut Camille Jordan  
Université Lyon I  
43 Blvd. du 11 Novembre 1918  
69622 Villeurbanne Cedex  
FRANCE

**Prof. Dr. Senya B. Shlosman**

Centre de Physique Théorique  
CNRS  
Luminy - Case 907  
13288 Marseille Cedex 09  
FRANCE

**Prof. Dr. Vladas Sidoravicius**

Courant Institute of Mathematical  
Sciences  
New York University  
251, Mercer Street  
New York, NY 10012-1110  
UNITED STATES

**Dr. Vittoria Silvestri**  
Centre for Mathematical Sciences  
University of Cambridge  
Wilberforce Road  
Cambridge CB3 0WB  
UNITED KINGDOM

**Yinon Spinka**  
Department of Mathematics  
School of Mathematical Sciences  
Tel Aviv University  
P.O.Box 39040  
Ramat Aviv, Tel Aviv 69978  
ISRAEL

**Prof. Dr. Alexandre Stauffer**  
Department of Mathematical Sciences  
University of Bath  
Claverton Down  
Bath BA2 7AY  
UNITED KINGDOM

**Dr. Eliran Subag**  
Courant Institute of Mathematical  
Sciences  
New York University  
251, Mercer Street  
New York, NY 10012-1110  
UNITED STATES

**Prof. Dr. Alain-Sol Sznitman**  
Departement Mathematik  
ETH-Zentrum  
Rämistrasse 101  
8092 Zürich  
SWITZERLAND

**Dr. Lorenzo Taggi**  
Fachbereich Mathematik  
Technische Universität Darmstadt  
Schloßgartenstr. 7  
64289 Darmstadt  
GERMANY

**Prof. Dr. Pierre Tarrès**  
CEREMADE  
Université Paris Dauphine  
Place du Marechal de Lattre de Tassigny  
75775 Paris Cedex 16  
FRANCE

**Dr. Vincent Tassion**  
Departement Mathematik  
ETH-Zentrum  
Rämistrasse 101  
8092 Zürich  
SWITZERLAND

**Prof. Augusto Teixeira**  
Instituto de Matematica Pura e Aplicada  
(IMPA)  
Jardim Botânico  
Estrada Dona Castorina, 110  
22460 Rio de Janeiro, RJ 320  
BRAZIL

**Dr. Marie Theret**  
UFR de Mathématiques  
Université Paris Diderot - Paris VII  
5, rue Thomas Mann  
75205 Paris Cedex 13  
FRANCE

**Prof. Dr. Balint Toth**  
Institute of Mathematics  
Technical University of Budapest  
Egry Jozsef u. 1  
1111 Budapest  
HUNGARY

**Prof. Dr. Amanda G. Turner**  
Department of Mathematics and  
Statistics  
University of Lancaster  
Fylde College, Bailrigg  
Lancaster LA1 4YF  
UNITED KINGDOM

**Dr. Daniel Ueltschi**

Mathematics Institute  
University of Warwick  
Gibbet Hill Road  
Coventry CV4 7AL  
UNITED KINGDOM

**Prof. Dr. Hao Wu**

Section of Mathematics  
University of Geneva  
2-4 Rue du Lièvre  
1211 Genève 4  
SWITZERLAND

**Dr. Grégoire Véchambre**

Department of Mathematics  
NYU Shanghai  
1555 Century Avenue, Pudong Xinqu  
Shanghai Shi 200122  
CHINA

**Prof. Dr. Xiaolin Zeng**

Department of Mathematics  
School of Mathematical Sciences  
Tel Aviv University  
P.O.Box 39040  
Ramat Aviv, Tel Aviv 69978  
ISRAEL

**Prof. Dr. Yvan Velenik**

Département de Mathématiques  
Université de Geneve  
Case Postale 64  
2-4 rue du Lievre  
1211 Genève 4  
SWITZERLAND

