

MATHEMATISCHES FORSCHUNGSINSTITUT OBERWOLFACH

Report No. 24/2019

DOI: 10.4171/OWR/2019/24

Nonlinear Hyperbolic Problems: Modeling, Analysis, and Numerics

Organized by

Rinaldo M. Colombo, Brescia

Philippe G. LeFloch, Paris

Christian Rohde, Stuttgart

Konstantina Trivisa, College Park

19 May – 25 May 2019

ABSTRACT. The workshop gathered together leading international experts, as well as most promising young researchers, working on the modelling, the mathematical analysis, and the numerical methods for nonlinear hyperbolic partial differential equations (PDEs). The meeting focussed on addressing outstanding issues and identifying promising new directions in all three fields, i.e. *modelling, analysis, and numerical discretization*. Key questions settled around the lack of well-posedness theories for multidimensional systems of conservation laws and the use of hyperbolic modelling beyond the classical topic of gas dynamics. A focal point in numerics has been the discretization of random evolutions and uncertainty quantification. Equally important, new multi-scale methods and schemes for asymptotic regimes have been considered.

Mathematics Subject Classification (2010): 35L65, 35L40.

Introduction by the Organizers

The mathematical theory of hyperbolic partial differential equations, in particular of conservation laws, saw an astonishing development in the past decades. The progress in analysis and numerics was mainly driven by challenges from continuum mechanics, a prominent role being played by shock waves in gas dynamics. Modeling through hyperbolic partial differential equations has now become a cornerstone in many other branches of sciences, for instance wherever nonlinear transport phenomena occur. In turn, these models pose completely new questions for the mathematical theory and the numerical analysis of hyperbolic equations.

The workshop programme settled around a varied series of presentations on fundamental issues of the field as well as the latest developments opening new pathways. Besides major senior researchers we welcomed quite a number of junior researchers giving inspiring lectures and contributing very actively to the overall joint discussions. Altogether 18 one-hour talks and some shorter presentations have been given. An intensive open-problem session completed the programme. Most of the 47 invitees originated from Europe and the United States but we welcomed also participants from China, Saudi Arabia and Taiwan.

The remainder of this introduction is devoted to a summary of the topics that have been addressed during the workshop.

Traditionally, well-posedness results for conservation laws have been split in two rather separated sets: those for scalar multi-D equations and those for 1D systems. The former are based on the classical Kruřkov Theorem, while the latter typically make use of the Glimm scheme or wave front tracking. In both cases entropy conditions ensure uniqueness. An exiting new development in recent years has been the discovery of non-unique entropy solutions for multi-D flow systems by exploiting convex integration tools. László Székelyhidi Jr. presented an overview and recent developments related to contact waves in ideal fluids. Christian Klingenberg showed the use of convex integration for various fluid systems. Gianluca Crippa elaborated on closely related regularity issues of the transport equation with rough coefficients, Alberto Bressan introduced a novel surprising non-uniqueness result for self-similar solutions of the full 2D Euler system. In the context of the complex system of ideal magnetohydrodynamics Heinrich Freistühler discussed the onset of instabilities and Franziska Weber considered models for turbulent flow. On the other hand entropy-like techniques are still a source to ensure well-posedness results. Denis Serre proposed a general L^p -theory for special multi-D Burgers-like systems and Sam G. Krupa extended the 1D well-posedness theory. Stability results for damped Euler (or more complex) flows have been discussed by Yachun Li, Tai-Ping Liu, Pierangelo Marcati, and Athanasios Tzavaras, whereas Constantine Dafermos used structural properties of relaxation balance laws for new well-posedness results.

Among the new promising areas where hyperbolic modelling plays an important role, let us mention the recent developments on non-local equations, evolutionary problems on networks, applications in social sciences, the use of the Wasserstein distance from optimal transport, and various aspects of control problems. Each of these notions applies to a variety of physical models, rises new analytic questions, and provides important insights for designing new numerical procedures. In particular control problems for hyperbolic transport deserve more attention as outlined in the presentation of Mauro Garavello. Felisia Angela Chiarello and Francesca Marcellini reported on recent findings for traffic flow problems. A relative-entropy theory for flows on graphs has been the topic of the lecture of Jan Giesselmann. More generally, non-local evolutions have been discussed by Paola Goatin and Elena Rossi. Closely related are equations with non-local, discontinuous or even

singular flux terms. Graziano Guerra and Wen Shen presented well-posedness results for this type of problems.

Collective transport models can be considered as prototypes for multi-scale transport that result in hydrodynamical models of essentially hyperbolic type. Examples range from cell dynamics to the self-organized movement of swarms, including even consensus procedures in human societies. Hydrodynamical limits of particle approaches via kinetic models produce new systems which extend the classical framework of Euler's equations of inviscid compressible flow to, e.g., self-organized hydromechanics. Multi-scale formulations that locally account for detailed particle dynamics have become popular in recent years. Eitan Tadmor's presentation focussed on all these developments.

All the topics mentioned above pose obvious joint numerical challenges. Specific numerical problems that arise in this framework are the construction of well-balanced schemes to recover (analytically sometimes even trivial) equilibrium solutions of hyperbolic balance laws at the numerical level. An overview on recent developments has been given by Alina Chertock. More specifically, Alexander Kurganov showed a new technique to integrate source term discretizations directly into the numerical flux. Another trend in numerics is related to the change of the type of equations in extreme parameter regimes as it naturally appears in multi-scale models. Manuel Torrilhon developed new model hierarchies to enable adaptive model choices. Relaxation approximations to preserve the asymptotic structure at the discrete level have been elaborated by Francois Bouchut.

A major challenge in the development of reliable algorithms is the intrinsic uncertainty in the initial and boundary data and in the coefficients of hyperbolic PDEs. The uncertainty is modeled by statistical and stochastic objects like the mean, the variance, higher moments and in some cases, the probability density function of the data or of the coefficients. The numerical issue of interest in this context is to compute statistical information about the solution, given statistical information about the input data. Let us also mention the connection with measure-valued and statistical solutions for conservation laws. The lectures of Michael Herty, Mária Lukáčová-Medvid'ová, and Bettina Wiebe focussed on these topics. Explicit time-discretizations for hyperbolic laws require the time-step to scale with the spatial discretization parameter in order to ensure discrete stability. Moving fronts, irregular boundaries can lead to very small cells. Sandra May and Maria Wiebe targeted this issue in the context of higher-order schemes and a free boundary value problem for nonclassical shock waves.

Acknowledgement: The MFO and the workshop organizers would like to thank the National Science Foundation for supporting the participation of junior researchers in the workshop by the grant DMS-1641185, "US Junior Oberwolfach Fellows". Moreover, the MFO and the workshop organizers would like to thank the Simons Foundation for supporting Wen Shen in the "Simons Visiting Professors" program at the MFO.

Workshop: Nonlinear Hyperbolic Problems: Modeling, Analysis, and Numerics

Table of Contents

François Bouchut (joint with Christophe Chalons, Sébastien Guisset) <i>A Two-Speed Relaxation System for Euler Equations, Application to the Low Mach limit</i>	1427
Alberto Bressan <i>On the Ill-posedness of the 2D Euler Equations</i>	1428
Alina Chertock (joint with Alexander Kurganov, Xin Liu) <i>An Asymptotic Preserving Scheme for the Two-Dimensional Shallow Water Equations with Coriolis Forces</i>	1432
Felisia Angela Chiarello (joint with Paola Goatin, Luis Miguel Villada) <i>Non-local Traffic Flow Models</i>	1434
Gianluca Crippa (joint with Laura Caravenna) <i>Uniqueness and Lagrangianity for Solutions with Lack of Integrability of the Continuity Equation</i>	1437
Heinrich Freistühler <i>Emergence of Unstable Modes for Magnetohydrodynamic Shock Waves</i> ..	1440
Mauro Garavello (joint with Rinaldo M. Colombo) <i>Consensus Games via Hyperbolic Conservation Laws</i>	1441
Jan Giesselmann (joint with Raul Borsche) <i>Relative Entropy for Isothermal Euler Equations on Networks</i>	1444
Paola Goatin (joint with Florent Berthelin) <i>Regularity Results for the Solutions of a Non-Local Model of Traffic Flow</i>	1447
Graziano Guerra (joint with Alberto Bressan, Wen Shen) <i>Backward Euler Approximations for Conservation Laws with Discontinuous Fluxes</i>	1449
Michael Herty and Stephan Gerster <i>Stochastic Galerkin Formulations for Hyperbolic Conservation Laws</i> ...	1451
Christian Klingenberg (joint with Eduard Feireisl, Simon Markfelder) <i>Convex Integraton Applied to the Multi-Dimensional Equations of Compressible Fluid Mechanics</i>	1455
Sam G. Krupa (joint with Alexis F. Vasseur) <i>Recent Results Pushing Forward Theory of Well-posedness for Hyperbolic Systems of Conservation Laws in One Space Dimension</i>	1456

Alexander Kurganov (joint with Yuanzhen Cheng, Alina Chertock, Shumo Cui, Michael Herty, Yongle Liu, Şeyma Nur Özcan, Eitan Tadmor, Tong Wu, Vladimir Zeitlin)	
<i>Well-Balanced Schemes via Flux Globalization</i>	1457
László Székelyhidi Jr.	
<i>Instabilities and Non-Uniqueness in Ideal Fluids</i>	1458
Yachun Li (joint with Hao Li, Shuai Xi, Shengguo Zhu)	
<i>Qualitative Studies on Radiation Hydrodynamics Equations</i>	1459
Tai-Ping Liu	
<i>On Well-Posedness of Weak Solutions</i>	1462
Mária Lukáčová-Medvidňová (joint with Eduard Feireisl, Hana Mizerová, Bangwei She)	
<i>The Role of Young Measures in Convergence Analysis of Compressible Flows</i>	1463
Francesca Marcellini (joint with Rinaldo M. Colombo, Helge Holden)	
<i>A Microscopic Model on a Traffic Network</i>	1464
Sandra May (joint with Christian Engwer, Andreas Nüßing, Florian Streitbürger)	
<i>A stabilized DG cut Cell Method for discretizing the Linear Transport Equation</i>	1467
Elena Rossi	
<i>Conservation and Balance Laws in Domains with Boundaries</i>	1470
Denis Serre (joint with Luis Silvestre)	
<i>The multi-dimensional Burgers Equation with L^p Initial Data</i>	1472
Wen Shen (joint with Alberto Bressan, Graziano Guerra)	
<i>Scalar Conservation Laws with Regulated Flux</i>	1474
Eitan Tadmor (joint with Ruiwen Shu)	
<i>Anticipation Dynamics</i>	1477
Manuel Torrilhon (joint with Julia Kowalski)	
<i>Elements of an Enhanced Shallow Flow Modeling Framework</i>	1480
Athanasios E. Tzavaras (joint with Jan Giesselmann, Corrado Lattanzio, Xiaokai Huo, Ansgar Jüngel)	
<i>High Friction Limits from Euler Flows to Gradient Flows</i>	1483
Franziska Weber (joint with Jacob Bedrossian, Michele Coti Zelati, Samuel Punshon-Smith)	
<i>A Sufficient Condition for the Kolmogorov 4/5 Law for Stationary Martingale Solutions to the 3D Navier-Stokes Equations</i>	1486

Bettina Wiebe (joint with Alina Chertock, Alexander Kurganov, Maria Lukáčová-Medvid'ová, Peter Spichtinger)	
<i>Uncertainty Quantification for Cloud Simulation</i>	1489
Maria Wiebe (joint with Christian Rohde)	
<i>Undercompressive Shock Waves in Anti-Plane Shear Dynamics</i>	1490

Abstracts

A Two-Speed Relaxation System for Euler Equations, Application to the Low Mach limit

FRANÇOIS BOUCHUT

(joint work with Christophe Chalons, Sébastien Guisset)

We introduce a new relaxation system [2] for the barotropic Euler equations, that generalizes the Suliciu relaxation system [1]. It has not only a relaxed pressure π , but also a relaxed velocity v , and it involves two parameter relaxation speeds a and b . The system has positive density and is entropy compatible in the sense that it has an extended entropy, under subcharacteristic conditions involving the two speeds, $a \geq b$ and $ab \geq \rho^2 p'(\rho)$. The case $a = b$ reduces to the classical Suliciu system with $v = u$ and the subcharacteristic condition $a^2 \geq \rho^2 p'(\rho)$. A main difference between the two speed case $a > b$ and the one-speed case $a = b$ is that the new one involves a viscous term in the density equation in the Chapman-Enskog expansion. This property is similar to the schemes considered in [4].

An approximate Riemann solver is deduced by solving the exact Riemann problem to the relaxation system, which is possible since it has all characteristic fields linearly degenerate.

The low Mach regime is known as being difficult to resolve numerically. A main difficulty is that the numerical viscosity is of the order of Δx times the size of the eigenvalues, which is of the order of $1/M$ with M the Mach number. Thus when $\Delta x/M$ is not small we lose the consistency. Many schemes have been proposed to solve the problem, see [3] for example. Such schemes are called asymptotic preserving, and they always reduce the numerical viscosity so that it remains of the order of Δx as $M \rightarrow 0$. However because of the reduced numerical viscosity, all these schemes are never proved to satisfy a discrete entropy inequality. Indeed stability in this context is in general a difficult task (often some checkerboard modes exist). Another issue in the low Mach limit is that in order to avoid small timesteps, it is desirable to design implicit schemes. This question is not discussed in the present work.

We prove that our two-speed relaxation solver is asymptotic preserving when making an appropriate choice of the speeds with b remaining bounded as $M \rightarrow 0$, and $a \sim 1/M^2$. It is the first time that a scheme is proved to be at the same time asymptotic preserving and verifies a discrete entropy inequality. This property enables also to prove that the consistency with the asymptotic incompressibility condition is uniform with respect to time, thus there is no growth of the divergence error with time. An important conclusion is that in order to be asymptotic preserving and entropy stable, a scheme must include a large numerical viscosity on the density. This is possible since in the low Mach limit the density is close to a constant.

A weakness of our numerical scheme is that it is explicit, and thus has a severe CFL condition. Further works will explore the possibility to derive an implicit scheme, while still keeping the AP property and the entropy inequality.

REFERENCES

- [1] F. Bouchut, *Nonlinear stability of finite volume methods for hyperbolic conservation laws, and well-balanced schemes for sources*, Frontiers in Mathematics, Birkhäuser Verlag, Basel, 2004.
- [2] F. Bouchut, C. Chalons, S. Guisset, *An entropy satisfying two-speed relaxation system for the barotropic Euler equations. Application to the numerical approximation of low Mach number flows*, preprint (2018).
- [3] F. Cordier, P. Degond, A. Kumbaro, *An asymptotic-Preserving ally-speed scheme for the Euler and Navier-Stokes equations*, J. Comput. Phys. **231** (2012), 5685–5704.
- [4] E. Feireisl, M. Lukacova-Medvidova, H. Mizerova, *A finite volume scheme for the Euler system inspired by the two velocities approach*, preprint (2018).

On the Ill-posedness of the 2D Euler Equations

ALBERTO BRESSAN

1. THE EULER EQUATIONS

Let $u = u(t, x)$ denote the velocity of a fluid, at time t and at a point x in space. The flow of a homogeneous, incompressible, non-viscous fluid in \mathbb{R}^2 is modeled by the Euler equations

$$(1) \quad \begin{cases} u_t + (u \cdot \nabla)u = -\nabla p & \text{balance of momentum,} \\ \operatorname{div} u \equiv 0 & \text{incompressibility condition.} \end{cases}$$

Here the scalar function p denotes the pressure [7].

For a given initial datum, the approach introduced by DeLellis and Székelyhidi [3], based on convex integration and Baire category, has shown the existence of infinitely many weak solutions with turbulent nature. All the usual admissibility criteria, based on energy or entropy dissipation, fail to select a unique solution [2, 4].

Aim of this note is to discuss “simplest possible” examples of non-uniqueness for the 2D Euler flow, motivating a general conjecture on the ill-posedness for this type of equations.

Calling $\omega = \operatorname{curl} u = (-u_{1,x_2} + u_{2,x_1})$ and taking the curl of both sides of (1) one obtains the linear transport equation for the vorticity

$$(2) \quad \omega_t + (u \cdot \nabla)\omega = 0.$$

The assumption that $\operatorname{div} u = 0$ implies the existence of a stream function ψ such that

$$(3) \quad u = \nabla^\perp \psi, \quad (u_1, u_2) = (-\psi_{x_2}, \psi_{x_1}).$$

We shall first consider solutions which are self-similar, so that

$$(4) \quad \begin{cases} u(t, x) &= t^{\mu-1}U\left(\frac{x}{t^\mu}\right), \\ \omega(t, x) &= t^{-1}\Omega\left(\frac{x}{t^\mu}\right), \\ \psi(t, x) &= t^{2\mu-1}\Psi\left(\frac{x}{t^\mu}\right), \end{cases}$$

for some constant $\mu > 1/2$. Inserting (4) in (2)-(3), one obtains the equations

$$(5) \quad \begin{cases} (\nabla^\perp \Psi - \mu y) \cdot \nabla \Omega &= \Omega, \\ \Delta \Psi &= \Omega, \end{cases} \quad U = \nabla^\perp \Psi.$$

2. AN INITIAL DATA WITH MULTIPLE SOLUTIONS

To construct two distinct, self-similar solutions to (1) with the same initial data, we consider an initial vorticity of the form

$$(6) \quad \omega(0, x) = r^{-1/\mu} \bar{\Omega}(\theta),$$

where $x = (r \cos \theta, r \sin \theta)$. As shown in Figure 1, left, we assume that $\bar{\Omega} \in C^\infty(\mathbb{R})$ is non-negative, smooth, periodic function which satisfies

$$(7) \quad \bar{\Omega}(\theta) = \bar{\Omega}(\pi + \theta), \quad \bar{\Omega}(\theta) = 0 \quad \text{if } \theta \in \left[\frac{\pi}{4}, \pi\right].$$

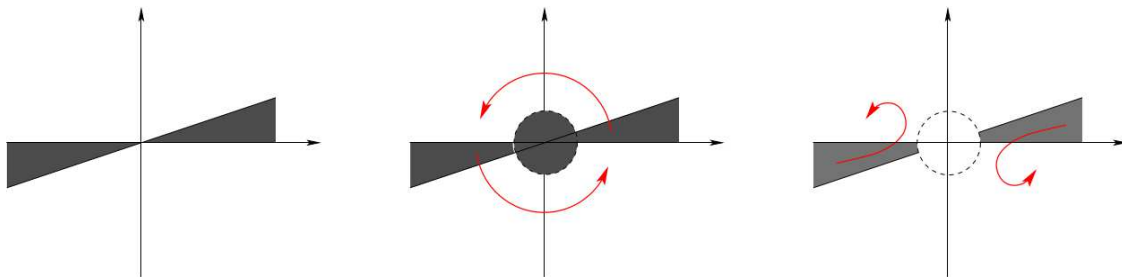

FIGURE 1. The supports of the initial vorticity. Left: the original datum (6). Center: the approximation (8). Right: the approximation (9).

We then consider two sequences of initial data, with vorticity $\bar{\omega}_1^\varepsilon, \bar{\omega}_2^\varepsilon \in L^\infty(\mathbb{R}^2)$, as shown in Figure 1, center and right. Namely

$$(8) \quad \omega_1^\varepsilon(0, x) = \bar{\omega}_1^\varepsilon(x) \doteq \begin{cases} |x|^{-1/\mu} \bar{\Omega}(\theta) & \text{if } |x| > \varepsilon, \\ \varepsilon^{-1/\mu} & \text{if } |x| \leq \varepsilon, \end{cases}$$

$$(9) \quad \omega_2^\varepsilon(0, x) = \bar{\omega}_2^\varepsilon(x) \doteq \begin{cases} |x|^{-1/\mu} \bar{\Omega}(\theta) & \text{if } |x| > \varepsilon, \\ 0 & \text{if } |x| \leq \varepsilon. \end{cases}$$

By Yudovich' theorem [8], for every $\varepsilon > 0$ the Cauchy problem for the incompressible Euler equation (1) with initial data (8) or (9) has a unique solution. Numerical

simulations of these solutions, performed by Wen Shen (Oxford, 2017), are shown in Figures 2 and 3, respectively. This provides numerical evidence that, as $\varepsilon \rightarrow 0$, the two approximations converge to very different limits. Both of these limits are solutions to the Cauchy problem with self-similar initial data (6).

The analytical background needed to transform these numerical simulations into a rigorous statement about non-uniqueness has been worked out in [1]. We remark that, toward this goal, standard a-posteriori error estimates do not suffice. Indeed, two main difficulties must be addressed:

- The solution Ψ of (5) is a function defined on the whole plane \mathbb{R}^2 , while the numerical approximation is computed only on a bounded domain \mathcal{D} .
- The exact solutions are not smooth, but contain a singularity at the center of each spiral. In a neighborhood of such point, the standard a-posteriori error estimates break down.

For the above reasons, one must construct (i) an analytical solution in the exterior of a large disc, (ii) an analytical solution in a neighborhood of the spirals' centers, and then (iii) patch these solutions together with the numerical solution computed on an intermediate domain. We remark that the resolution of the singularity near the spiral's center heavily relies on the fundamental work of V. Elling [5, 6].

3. INCURABLY ILL-POSED PROBLEMS

The previous discussion indicates that, for multi-dimensional Euler equations, there is no way to select a unique solution depending continuously on the initial data. This fact can be more precisely stated as follows. Consider a general Cauchy problem on a Banach space X :

$$\frac{d}{dt}u = \Phi(u) \quad u(0) = \bar{u} \in X \quad (CP)$$

Definition. *The Cauchy problem (CP) is incurably ill posed on the space X if there exists dense subsets $\mathcal{D}^u, \mathcal{D}^m \subset X$ such that the following holds.*

- For each initial datum $\bar{v} \in \mathcal{D}^u$, there exists a time $T(\bar{v}) > 0$ such that (CP) has a unique local solution $v(t) = S_t \bar{v}$, $t \in [0, T(\bar{v})]$.
- For each initial datum $\bar{u} \in \mathcal{D}^m$, there exist two sequences $\bar{v}_n \rightarrow \bar{u}$, $\bar{w}_n \rightarrow \bar{u}$, with $\bar{v}_n, \bar{w}_n \in \mathcal{D}^u$, such that for some $\tau > 0$ the corresponding sequences of solutions converge to different limits:

$$v_n(t) \rightarrow u(t), \quad w_n(t) \rightarrow \tilde{u}(t), \quad u(t) \neq \tilde{u}(t) \quad \forall t \in]0, \tau]$$

Notice that the above implies that the map $(t, \bar{u}) \mapsto S_t \bar{u}$, $\bar{u} \in \mathcal{D}^u$, does NOT admit any continuous extension to any open set.

We now observe that any initial datum can be approximated by a smooth one. In turn, a smooth initial datum can be locally perturbed by adding a small amount of vorticity concentrated on two wedges, as shown in Fig. 1, thus obtaining two distinct limit solutions. This motivates the following

Conjecture. *The 2-dimensional Euler equations (both incompressible and compressible) are incurably ill-posed on any space that contains $H^1(\mathbb{R}^2)$.*

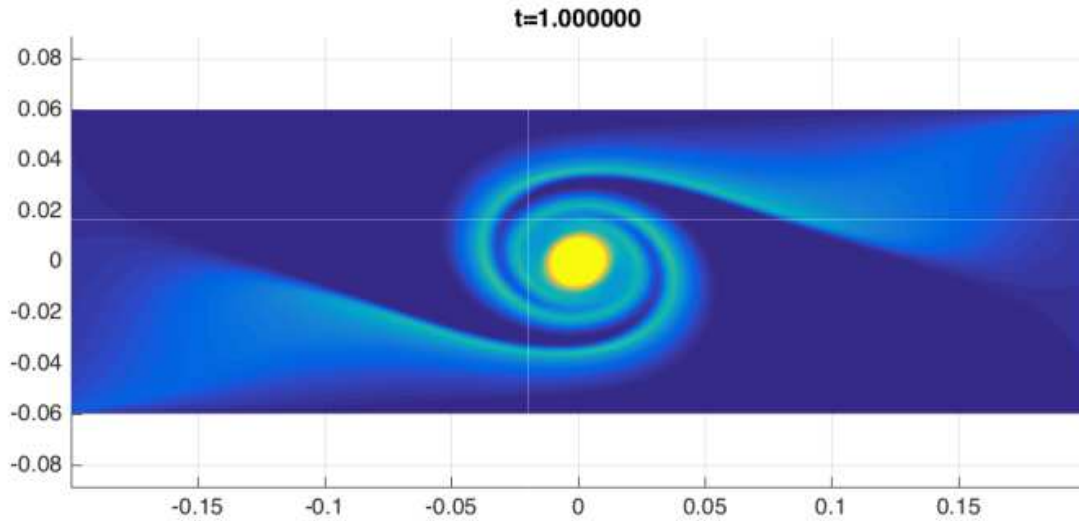

FIGURE 2. A single symmetric spiral. This depicts the solution to (1) at time $t = 1$, with initial data (8) with $\varepsilon > 0$ small. Here $\mu = 5/7$.

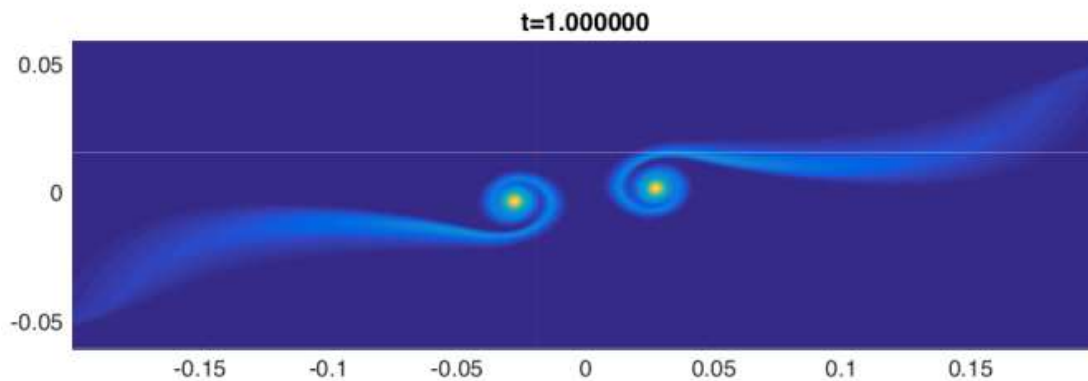

FIGURE 3. A symmetric solution containing two spirals. This depicts the solution to (1) at time $t = 1$, with initial data (9) with $\varepsilon > 0$ small. Here $\mu = 5/7$.

REFERENCES

- [1] A. Bressan and R. Murray, Multiple self-similar solutions to the incompressible Euler equations, to appear.
- [2] E. Chiodaroli, C. De Lellis, and O. Kreml, Global ill-posedness of the isentropic system of gas dynamics. *Comm. Pure Appl. Math.* **68** (2015), 1157–1190.
- [3] C. De Lellis and L. Székelyhidi, The Euler equations as a differential inclusion. *Ann. Math.* **170** (2009), 1417–1436.

- [4] C. De Lellis and L. Székelyhidi, On admissibility criteria for weak solutions of the Euler equations. *Arch. Rat. Mech. Anal.* **195** (2010), 225–260.
- [5] V. Elling, Algebraic spiral solutions of 2d incompressible Euler. *J. Differential Equat.* **255** (2013), 3749–3787.
- [6] V. Elling, Self-Similar 2d Euler solutions with mixed-sign vorticity *Commun. Math. Phys.* **348** (2016), 27–68.
- [7] C. Marchioro and M. Pulvirenti, *Mathematical Theory of Incompressible Nonviscous Fluids*. Springer, 1994.
- [8] V. Yudovich. Non-stationary flow of an ideal incompressible liquid. *Comp. Math. Math. Phys.* **3** (1963), 1407–1457.

An Asymptotic Preserving Scheme for the Two-Dimensional Shallow Water Equations with Coriolis Forces

ALINA CHERTOCK

(joint work with Alexander Kurganov, Xin Liu)

We consider the two-dimensional (2-D) Saint-Venant system of shallow water equations with Coriolis forces:

$$\begin{aligned}
 (1) \quad & h_t + (hu)_x + (hv)_y = 0, \\
 (2) \quad & (hu)_t + \left(hu^2 + \frac{g}{2}h^2\right)_x + (huv)_y = fhv, \\
 (3) \quad & (hv)_t + (huv)_x + \left(hv^2 + \frac{g}{2}h^2\right)_y = -fhu,
 \end{aligned}$$

where t is the time, x and y are horizontal spatial coordinates, $h(x, y, t)$ is the water depth, $u(x, y, t)$ and $v(x, y, t)$ are the x - and y -components of the flow velocity, g is the constant gravitational acceleration, and f is the Coriolis parameter.

The system (1)–(3) is often used to model atmospheric and oceanic flows. In such large scale phenomena, Froude number is used to describe different flow regimes and, as discussed in [16], low Froude numbers give rise to multiple spatial or temporal scales or both. Low Froude numbers are typically observed in many physics, engineering and industrial phenomena, for example, as described in [1], the reference Froude number is around 0.03 in the atmospheric and oceanic flows. We note that the zero Froude number limit solution is challenging due to the following two major reasons. First, the type of the Saint-Venant system changes from hyperbolic to mixed hyperbolic-elliptic. Second, the system becomes very stiff, which makes it extremely difficult to design efficient and accurate methods for its numerical solution. For example, if conventional explicit schemes are used, then the spatial mesh size is supposed to be proportional to the Froude number and the time-step size, restricted by the CFL condition, is supposed to be even smaller as the propagation speeds of the system (1)–(3) are inversely proportional to the Froude number; see, e.g., [7, 8, 22]. This may lead to very expensive computational cost when numerically solving the Saint-Venant system with Coriolis forces in the low Froude number regime.

In order to overcome the aforementioned difficulties, a class of algorithms named asymptotic preserving (AP) schemes have been developed and recently attracted a lot of attentions. According to definition in [11, 12], an AP scheme gives a consistent and stable discretization of a continuous physical model for all values of a singular perturbation parameter (throughout the paper, we will denote this parameter by ε). In particular, the scheme is AP if it is uniformly stable in ε , that is, the stability time-step restriction is independent of ε .

The AP schemes have been widely studied for the kinetic equations; see, e.g., [10, 13, 14] and references therein. They have been also applied to the low Mach number compressible Euler and Navier-Stokes equations in [2, 3, 4, 5, 9, 15, 21]. Several AP schemes have been developed for the shallow water equations; see e.g., [1, 6, 23]. Adding Coriolis forces to the Saint Venant system brings another level of complexity since in this case, not only the hydrostatic pressure, but also the Coriolis term is stiff in the low Froude number regime. To the best of our knowledge, no AP scheme for the shallow water equations with Coriolis forces has been ever reported; we can only refer the reader to the recent paper [24], where an asymptotically consistent method has been developed for rotating shallow water equations with Coriolis forces.

In this paper, we develop an AP scheme for the shallow water equations with Coriolis forces. Our method is based on the hyperbolic flux splitting proposed in [9] in the context of isentropic Euler and Navier-Stokes equations. We split the flux into the stiff and nonstiff parts and then use an implicit-explicit approach: apply an explicit hyperbolic solver (we use the second-order central-upwind scheme developed in [19, 20] for general multidimensional hyperbolic systems of conservation laws; also see [17, 18]) to the nonstiff part of the system while treating the stiff part of it implicitly. Moreover, the stiff part of the flux is linear and therefore we reduce the implicit stage of the proposed method to solving a Poisson-type elliptic equation, which is discretized using a standard second-order central difference scheme.

REFERENCES

- [1] G. BISPEN, K. R. ARUN, M. LUKÁČOVÁ-MEDVIĐOVÁ, AND S. NOELLE, *IMEX large time step finite volume methods for low Froude number shallow water flows*, Commun. Comput. Phys., 16 (2014), pp. 307–347.
- [2] G. BISPEN, M. LUKÁČOVÁ-MEDVIĐOVÁ, AND L. YELASH, *Asymptotic preserving IMEX finite volume schemes for low Mach number Euler equations with gravitation*, J. Comput. Phys., 335 (2017), pp. 222–248.
- [3] F. CORDIER, P. DEGOND, AND A. KUMBARO, *An asymptotic-preserving all-speed scheme for the Euler and Navier-Stokes equations*, J. Comput. Phys., 231 (2012), pp. 5685–5704.
- [4] P. DEGOND AND M. TANG, *All speed scheme for the low Mach number limit of the isentropic Euler equations*, Commun. Comput. Phys., 10 (2011), pp. 1–31.
- [5] G. DIMARCO, R. LOUBÈRE, AND M.-H. VIGNAL, *Study of a new asymptotic preserving scheme for the Euler system in the low Mach number limit*, SIAM J. Sci. Comput., 39 (2017), pp. A2099–A2128.
- [6] A. DURAN, F. MARCHE, R. TURPAULT, AND C. BERTHON, *Asymptotic preserving scheme for the shallow water equations with source terms on unstructured meshes*, J. Comput. Phys., 287 (2015), pp. 184–206.

- [7] H. GUILLARD AND A. MURRONE, *On the behavior of upwind schemes in the low Mach number limit: II. Godunov type schemes*, *Comput. & Fluids*, 33 (2004), pp. 655–675.
- [8] H. GUILLARD AND C. VIOZAT, *On the behaviour of upwind schemes in the low Mach number limit*, *Comput. & Fluids*, 28 (1999), pp. 63–86.
- [9] J. HAACK, S. JIN, AND J.-G. LIU, *An all-speed asymptotic-preserving method for the isentropic Euler and Navier-Stokes equations*, *Commun. Comput. Phys.*, 12 (2012), pp. 955–980.
- [10] J. HU, S. JIN, AND Q. LI, *Asymptotic-preserving schemes for multiscale hyperbolic and kinetic equations*, in *Handbook of numerical methods for hyperbolic problems*, vol. 18 of *Handb. Numer. Anal.*, Elsevier/North-Holland, Amsterdam, 2017, pp. 103–129.
- [11] S. JIN, *Runge-Kutta methods for hyperbolic conservation laws with stiff relaxation terms*, *J. Comput. Phys.*, 122 (1995), pp. 51–67.
- [12] ———, *Efficient asymptotic-preserving (AP) schemes for some multiscale kinetic equations*, *SIAM J. Sci. Comput.*, 21 (1999), pp. 441–454 (electronic).
- [13] ———, *Asymptotic preserving (ap) schemes for multiscale kinetic and hyperbolic equations: a review*, *Riv. Mat. Univ. Parma*, 3 (2012), pp. 177–2016.
- [14] S. JIN, L. PARESCHI, AND G. TOSCANI, *Uniformly accurate diffusive relaxation schemes for multiscale transport equations*, *SIAM J. Numer. Anal.*, 38 (2000), pp. 913–936.
- [15] R. KLEIN, *Semi-implicit extension of a Godunov-type scheme based on low Mach number asymptotics, I: One-dimensional flow*, *J. Comput. Phys.*, 121 (1995), pp. 213–237.
- [16] R. KLEIN, E. MIKUSKY, AND A. OWINOH, *Multiple scales asymptotics for atmospheric flows*, in *European Congress of Mathematics*, *Eur. Math. Soc.*, Zürich, 2005, pp. 201–220.
- [17] A. KURGANOV, *Central schemes: a powerful black-box solver for nonlinear hyperbolic PDEs*, in *Handbook of numerical methods for hyperbolic problems*, vol. 17 of *Handb. Numer. Anal.*, Elsevier/North-Holland, Amsterdam, 2016, pp. 525–548.
- [18] A. KURGANOV AND C.-T. LIN, *On the reduction of numerical dissipation in central-upwind schemes*, *Commun. Comput. Phys.*, 2 (2007), pp. 141–163.
- [19] A. KURGANOV, S. NOELLE, AND G. PETROVA, *Semi-discrete central-upwind scheme for hyperbolic conservation laws and Hamilton-Jacobi equations*, *SIAM J. Sci. Comput.*, 23 (2001), pp. 707–740.
- [20] A. KURGANOV AND E. TADMOR, *Solution of two-dimensional riemann problems for gas dynamics without Riemann problem solvers*, *Numer. Methods Partial Differential Equations*, 18 (2002), pp. 584–608.
- [21] S. NOELLE, G. BISPEN, K. R. ARUN, M. LUKÁČOVÁ-MEDVIĐOVÁ, AND C.-D. MUNZ, *A weakly asymptotic preserving low Mach number scheme for the Euler equations of gas dynamics*, *SIAM J. Sci. Comput.*, 36 (2014), pp. B989–B1024.
- [22] F. RIEPER, *On the dissipation mechanism of upwind-schemes in the low Mach number regime: a comparison between Roe and HLL*, *J. Comput. Phys.*, 229 (2010), pp. 221–232.
- [23] S. VATER AND R. KLEIN, *A semi-implicit multiscale scheme for shallow water flows at low Froude number*, *Commun. Appl. Math. Comput. Sci.*, 13 (2018), pp. 303–336.
- [24] H. ZAKERZADEH, *The RS-IMEX scheme for the rotating shallow water equations with the Coriolis force*, in *Finite volumes for complex applications VIII—hyperbolic, elliptic and parabolic problems*, vol. 200 of *Springer Proc. Math. Stat.*, Springer, Cham, 2017, pp. 199–207.

Non-local Traffic Flow Models

FELISIA ANGELA CHIARELLO

(joint work with Paola Goatin, Luis Miguel Villada)

Non-local interactions at the microscopic level can be described through macroscopic models based on integro-differential equations. Conservation laws with non-local flux appear in models of sedimentation in porous media, granular flows,

vehicular traffic and crowd dynamics, supply chains, etc. For example, non-local traffic flow models are intended to describe the behavior of drivers that adapt their speed to the downstream traffic conditions. This can be expressed by a non-local velocity function depending on a weighted integral of the downstream density. In this talk, we consider the framework of the non-local traffic flow models.

We study the following scalar conservation law with non-local flux

$$(1) \quad \partial_t \rho + \partial_x (f(\rho)v(\omega_\eta * \rho)) = 0, \quad x \in \mathbb{R}, t > 0,$$

where

$$(2) \quad \omega_\eta * \rho(t, x) := \int_x^{x+\eta} \omega_\eta(y-x)\rho(t, y)dy, \quad \eta > 0.$$

In (1), (2), we assume the following hypotheses:

$$(H) \quad \begin{aligned} f &\in \mathbf{C}^1(I; \mathbb{R}^+), & I &= [a, b] \subseteq \mathbb{R}^+, \\ v &\in \mathbf{C}^2(I; \mathbb{R}^+) \text{ s.t. } & v' &\leq 0, \\ \omega_\eta &\in \mathbf{C}^1([0, \eta]; \mathbb{R}^+) \text{ s.t. } & \omega'_\eta &\leq 0 \text{ and } \int_0^\eta \omega_\eta(x)dx := J_0, \forall \eta > 0, \\ & & \lim_{\eta \rightarrow \infty} \omega_\eta(0) &= 0. \end{aligned}$$

This class of equations includes in particular some vehicular traffic flow models, where $\eta > 0$ is proportional to the look-ahead distance and the integral J_0 is the interaction strength (here assumed to be independent of η). In this setting, the non-local dependence of the speed function v can be interpreted as the reaction of drivers to a weighted mean of the downstream traffic density. These models are characterized by the presence of an anisotropic discontinuous kernel, which makes general theoretical results [1, 2, 4] inapplicable as such. On the other side, the specific monotonicity assumptions on the speed function v and the kernel ω_η ensure nice properties of the corresponding solutions, such as a strong maximum principle (both from below and above) and the absence of unphysical oscillations due to a sort of monotonicity preservation, which make the choice (2) interesting and justified from the modeling perspective. We prove the well-posedness of entropy weak solutions for (1) coupled with an initial condition $\rho_0 \in \text{BV}(\mathbb{R}; I)$. We approximate the problem by a Lax-Friedrichs scheme and we provide \mathbf{L}^∞ and BV estimates for the sequence of approximate solutions. Stability with respect to the initial data is obtained from the entropy condition through the doubling of variable technique. The limit model as the kernel support tends to infinity is also presented.

After that, we consider the following class of non-local systems of M conservation laws in one space dimension:

$$(3) \quad \partial_t \rho_i(t, x) + \partial_x (\rho_i(t, x)v_i((r * \omega_i)(t, x))) = 0, \quad i = 1, \dots, M,$$

where

$$(4) \quad r(t, x) := \sum_{i=1}^M \rho_i(t, x),$$

$$(5) \quad v_i(\xi) := v_i^{\max} \psi(\xi),$$

$$(6) \quad (r * \omega_i)(t, x) := \int_x^{x+\eta_i} r(t, y) \omega_i(y - x) dy,$$

and we assume:

- (H1) The convolution kernels $\omega_i \in \mathbf{C}^1([0, \eta_i]; \mathbb{R}^+)$, $\eta_i > 0$, are non-increasing functions such that $\int_0^{\eta_i} \omega_i(y) dy = J_i$. We set $W_0 := \max_{i=1, \dots, M} \omega_i(0)$.
- (H2) v_i^{\max} are the maximal velocities, with $0 < v_1^{\max} \leq v_2^{\max} \leq \dots \leq v_M^{\max}$.
- (H3) $\psi : \mathbb{R}^+ \rightarrow \mathbb{R}^+$ is a smooth non-increasing function such that $\psi(0) = 1$ and $\psi(r) = 0$ for $r \geq 1$ (for simplicity, we can consider the function $\psi(r) = \max\{1 - r, 0\}$).

We couple (3) with an initial datum

$$(7) \quad \rho_i(0, x) = \rho_i^0(x), \quad i = 1, \dots, M.$$

Model (3) is obtained generalizing the n -populations model for traffic flow described in [3] and it is a multi-class version of the one dimensional scalar conservation law with non-local flux proposed in [5], where ρ_i is the density of vehicles belonging to the i -th class, η_i is proportional to the look-ahead distance and J_i is the interaction strength. In our setting, the non-local dependence of the speed functions v_i describes the reaction of drivers that adapt their velocity to the downstream traffic, assigning greater importance to closer vehicles. We allow different anisotropic kernels for each equation of the system. The model takes into account the distribution of heterogeneous drivers and vehicles characterized by their maximal speeds and look-ahead visibility in a traffic stream. We prove the existence for small times of weak solutions for this class of non-local systems in one space dimension. We approximate the problem by a Godunov type numerical scheme and we provide uniform \mathbf{L}^∞ and BV estimates for the sequence of approximate solutions, locally in time. We present some numerical simulations illustrating the behavior of different classes of vehicles and we analyze two cost functionals measuring the dependence of congestion on traffic composition. Finally, we present a generalization of the L-AR schemes introduced in [6, 7], in order to compute approximate solutions of the non-local multi-class model (3) proposed in [10]. In [6], one step Lagrangian-antidiffusive remap (L-AR) schemes were applied to multi-class Lighthill-Whitham-Richards (MCLWR) traffic models and in [7] this schemes were extended to polydisperse sedimentation models. L-AR schemes do not rely on spectral(characteristics) information and their implementation is as easy as that one of first- and second-order of accuracy schemes introduced in [8]. Nevertheless, the L-AR are more accurate and efficient. We recover some properties of the schemes in both scalar and multi-class cases. In the scalar case, we obtain uniform \mathbf{L}^∞ , BV estimates on the approximate solutions computed through the

L-AR schemes in order to prove the existence of weak solutions. Finally, we show some numerical simulations, analyzing the \mathbf{L}^1 -error of the approximate solutions of (3) computed with different schemes and considering smooth and discontinuous initial data.

REFERENCES

- [1] A. Aggarwal, R. M. Colombo, and P. Goatin. *Nonlocal systems of conservation laws in several space dimensions*. SIAM J. Numer. Anal., **53(2)**:963–983, 2015.
- [2] P. Amorim, R. M. Colombo, and A. Teixeira. *On the numerical integration of scalar nonlocal conservation laws*. ESAIM M2AN, **49(1)**:19–37, 2015.
- [3] S. Benzoni-Gavage and R. M. Colombo. *An n -populations model for traffic flow*. European J. Appl. Math., **14(5)**:587–612, 2003.
- [4] F. Betancourt, R. Bürger, K. H. Karlsen, and E. M. Tory. *On nonlocal conservation laws modelling sedimentation*. Nonlinearity, **24(3)**:855–885, 2011.
- [5] S. Blandin and P. Goatin. *Well-posedness of a conservation law with non-local flux arising in traffic flow modeling*. Numer. Math., **132(2)**:217–241, 2016.
- [6] R. Bürger, C. Chalons, and L. M. Villada. *Antidiffusive and random-sampling lagrangian-remap schemes for the multiclass Lighthill-Whitham-Richards traffic model*. SIAM J. Sci. Comput., **35(6)**:B1341–B1368, 2013.
- [7] R. Bürger, C. Chalons, and L. M. Villada. *Antidiffusive Lagrangian-remap schemes for models of polydisperse sedimentation*. Numerical Methods for Partial Differential Equations, **32(4)**:1109–1136, 2016.
- [8] R. Bürger, A. García, K. Karlsen, and J. Towers. *A family of numerical schemes for kinematic flows with discontinuous flux*. Journal of Engineering Mathematics, **60(3-4)**:387–425, 2008.
- [9] F. A. Chiarello and P. Goatin. *Global entropy weak solutions for general non-local traffic flow models with anisotropic kernel*. ESAIM: M2AN, **52(1)**:163–180, 2018.
- [10] F. A. Chiarello and P. Goatin. *Non-local multi-class traffic flow models*. Netw. Heterog. Media, **14(2)**:371 – 387, 2019.
- [11] F. A. Chiarello, P. Goatin, and L. M. Villada. *Lagrangian-Antidiffusive Remap schemes for non-local multi-class traffic flow models*. Preprint, Dec. 2018.

Uniqueness and Lagrangianity for Solutions with Lack of Integrability of the Continuity Equation

GIANLUCA CRIPPA

(joint work with Laura Caravenna)

We consider weak solutions $u = u(t, x)$ to the *continuity equation* in d space dimensions

$$\partial_t u + \operatorname{div}(bu) = 0,$$

where the vector field $b = b(t, x)$ is assumed to be bounded and divergence-free and belongs to the Sobolev space $W^{1,p}(\mathbb{R}^d)$ uniformly in time. The solution u is assumed to belong to the space $L^q(\mathbb{R}^d)$ uniformly in time and we denote by \bar{u} its initial value.

Under the assumption that

$$\frac{1}{p} + \frac{1}{q} < 1 + \frac{1}{d} \quad (\text{Regime 1}),$$

by Sobolev embedding the product bu is locally integrable, which allows for a definition of *distributional solutions* via the condition

$$\iint u(\partial_t \varphi + b \cdot \nabla \varphi) dx dt = - \int \bar{u} \varphi(0, \cdot) dx \quad \forall \varphi \in \text{Lip}_{t,x}.$$

On the other hand, *Lagrangian solutions* are defined without any condition on the integrability index q via the requirement that

$$u(t, X(t, x)) = \bar{u}(x),$$

where $X = X(t, x)$ is the so-called *regular Lagrangian flow* associated to the vector field b , which exists and is unique under the assumed regularity for b thanks to the DiPerna-Lions theory [4].

It is easy to see that a Lagrangian solution is a distributional solution, provided the latter is defined. In this note we would like to discuss the converse implication: is every distributional solution a Lagrangian solution? The answer is trivially positive in case of uniqueness of distributional solutions. This happens in the setting of the DiPerna-Lions theory [4], which however requires the condition

$$\frac{1}{p} + \frac{1}{q} \leq 1 \quad (\text{Regime 2}).$$

On the other hand, in a series of recent paper [5, 6, 7], Modena, Sattig, and Székelyhidi constructed examples of non-unique (and therefore, non-Lagrangian) distributional solutions out of Regime 1. Let us point out that the vector field enjoys the integrability needed in order to define distributional solutions due to the construction procedure, and not by Sobolev embeddings.

We therefore focus our attention on the “no-man’s-land” between Regimes 1 and 2. Is it true that distributional solutions are unique and Lagrangian for

$$1 < \frac{1}{p} + \frac{1}{q} < 1 + \frac{1}{d} \quad ?$$

In a joint work with Laura Caravenna [1, 2] we provide some partial results for $p > d$ and $q = 1$. In this case, we can prove uniqueness and Lagrangianity of distributional solutions, provided a further assumption on so-called *forward-backward integral curves* of the vector field is satisfied (more details on this will be presented in the following).

The basic idea is to try to derive a (weak) Lagrangian formulation from the distributional formulation. This can be done by a change of variable, which amounts to using

$$\varphi(t, x) = \Phi(t, X^{-1}(t, \cdot)(x))$$

as test function in the distributional formulation, where Φ is a test function for the weak Lagrangian formulation. The problem is that the flow, as well as its inverse, are not Lipschitz in the space variable; therefore, such a function φ is not an admissible test function in the distributional formulation.

However, the regularity estimates in [3] ensure Lipschitz regularity of the flow on a large set (in fact, even with some quantification of the Lipschitz constant).

Therefore, the function φ defined a few lines above is Lipschitz along integral curves of the vector field, and Euclidean-Lipschitz on a large set.

Let us assume for a moment that we can extend the function φ from the set on which it is Euclidean-Lipschitz to the whole space in such a way that the extension $\tilde{\varphi}$ is

- Lipschitz along integral curves, with a quantitative control on the Lipschitz constant, and
- globally Euclidean-Lipschitz.

It is then easy to see that the error (when replacing Φ by the corresponding $\tilde{\Phi}$) in the weak Lagrangian formulation will roughly be

$$\iint_{x \in \text{small set}} u(t, X(t, x)) \partial_t \tilde{\Psi}(t, x) dx dt,$$

which can be made arbitrarily small.

We therefore reduced our PDE problem to a real analysis problem, specifically to a Lipschitz extension lemma for two non-equivalent distances: the geodesic distance (which is a degenerate distance) and the Euclidean distance.

Our strategy to approach this question consists in interpolating these two distances by a family of distances d_λ , with $0 < \lambda \leq 1$, in such a way that displacements transversal to the integral curves are weighted by d_λ with a factor $1/\lambda$. It is possible to see that:

- for every $0 < \lambda \leq 1$, the distance d_λ is equivalent to the Euclidean distance, but the equivalence constant degenerates as $\lambda \downarrow 0$,
- a limit distance $d_0 = \lim_{\lambda \downarrow 0} d_\lambda$ is well defined,
- $d_0(x, y)$ can be characterised as the minimal length of the interval of the parameters of any forward-backward integral curve joining x and y .

In the last item above by forward-backward integral curves we mean curves that travel “forward in time” along the vector field (as standard integral curves do), or “backward in time” along the vector field. They are geometric objects, and in general the interval of parameters of such curves is larger than the time-interval that they span.

Within this setting, it is possible to prove the convergence of the Lipschitz constants associated to the family of distances, namely that $\text{Lip}_\lambda \phi \rightarrow \text{Lip}_0 \phi$. This is a nontrivial information, as one in general would only have semicontinuity. The proof relies on the uniform continuity of the vector field, which follows from the Sobolev regularity. From this convergence lemma the extension lemma follows in a fairly easy way.

In order to apply this general setting to our PDE problem we face two potential gaps:

- there can be integral curves that are not in the regular Lagrangian flow,
- there can be forward-backward integral curves that are not “trivial” reparametrizations of integral curves.

By an anisotropic maximal-functional argument reminiscent of the approach in [3] we can show that the first gap is not present, in that we have a.e. pointwise uniqueness of integral curves. On the other hand, we are currently not able to exclude in general the presence of a large set of nontrivial forward-backward integral curves. The a.e. triviality of forward-backward integral curves has therefore to be assumed as an extra condition in our result.

REFERENCES

- [1] L. Caravenna & G. Crippa, *Uniqueness and Lagrangianity for solutions with lack of integrability of the continuity equation*, C.R. Math. Acad. Sci. Paris **354** (2016), no. 12, 1168–1173.
- [2] L. Caravenna & G. Crippa, *A Directional Lipschitz Extension Lemma, with Applications to Uniqueness and Lagrangianity for the Continuity Equation*, arXiv preprint (2018).
- [3] G. Crippa & C. De Lellis, *Estimates and regularity results for the DiPerna-Lions flow*, J. Reine Angew. Math. **616** (2008), 15–46.
- [4] R. J. DiPerna & P.-L. Lions, *Ordinary differential equations, transport theory and Sobolev spaces*, Invent. Math. **98** (1989), no. 3, 511–547.
- [5] S. Modena & L. Székelyhidi, *Non-uniqueness for the transport equation with Sobolev vector fields*, accepted for the publication on Annals of PDE (2018).
- [6] S. Modena & L. Székelyhidi, *Non-renormalized solutions to the continuity equation*, arXiv preprint (2018).
- [7] S. Modena & G. Sattig, *Convex integration solutions to the transport equation with full dimensional concentration*, arxiv preprint (2019).

Emergence of Unstable Modes for Magnetohydrodynamic Shock Waves

HEINRICH FREISTÜHLER

The talk reported a particular analytical result which identifies a critical manifold in parameter space across which slow ideal magnetohydrodynamic shock waves in several space dimensions undergo a transition from uniform stability to strong instability and details of how this happens. To be precise, the associated Lopatin-ski determinant, a function both of a temporal Laplace-transform dual variable λ and a transverse wave number ω , has a pair of zeros crossing the imaginary axis at critical values of λ , in a key case for $\lambda=0$. This result, for the case of the full temperature-dependent polytropic gas, builds on an earlier one on the isothermal case that was presented in [2]. It strengthens a result obtained in [2] which shows numerically that in the presence of dissipative effects the same shocks develop into galloping waves upon the transition to instability.

REFERENCES

- [1] Barker B., Monteiro R., Zumbrun K. *Transverse bifurcation of viscous slow MHD shocks*. arXiv:1901.09153 (2019)
- [2] H. Freistühler, F. Kleber, J. Schropp: *Emergence of unstable modes for classical shock waves in isothermal ideal MHD*. Phys. D 358 (2017), 25–32.

Consensus Games via Hyperbolic Conservation Laws

MAURO GARAVELLO

(joint work with Rinaldo M. Colombo)

We consider a model describing a finite group of *leaders*, or *agents*, whose aim is to drift the consensus of a variety of individuals towards some preassigned targets. We denote the *positions* of the k agents by $P_1, P_2, \dots, P_k \in \mathbb{R}^N$, and the individuals' distribution by $\rho \in L^1(\mathbb{R}^N)$. The complete dynamics is given by the following system

$$(1) \quad \begin{cases} \partial_t \rho + \operatorname{div}_x (\rho v(t, x, P_1(t), \dots, P_k(t))) = 0, & t > 0, x \in \mathbb{R}^N, \\ \dot{P}_i(t) = u_i(t), & t > 0, i = 1, \dots, k, \\ \rho(0, x) = \bar{\rho}(x), & x \in \mathbb{R}^N, \\ P_i(0) = \bar{P}_i, & i = 1, \dots, k, \end{cases}$$

where $t > 0$ is the time, $x \in \mathbb{R}^N$ is space coordinate, v is the velocity of individuals, u_i are controls, and $\bar{\rho}$ and \bar{P}_i are initial conditions. The vector field v encodes the interaction among individuals and agents, which can be attractive, repulsive, or both. As usual in control theory, it is natural to assume that the agents' speeds u_i are bounded by a maximal velocity $U > 0$, so that $\|u_i\| \leq U$.

Each agent P_i aims to maximize its own consensus. In this setting the consensus is modeled by a fixed region $\mathcal{T}_i \subset \mathbb{R}^N$, called *target*. Hence the goal of the leader P_i is to drift many individuals as possible towards \mathcal{T}_i , within time $T > 0$, i.e. to minimize the functional

$$(2) \quad \mathcal{J}_i(u) = \int_{\mathbb{R}^N} \rho(T, x) \psi_i(x) dx$$

where $\psi_i \in L^\infty_{loc}(\mathbb{R}^N; \mathbb{R})$. Typically $\psi_i = d(x, \mathcal{T}_i)$, i.e. the distance between x and the target \mathcal{T}_i .

This structure is suitable for several control/game theoretic concepts, which comprehend optimal control and Nash equilibria. In this note, we present the control strategy u , introduced in [1], which is *non anticipative* (its value at time t does not require any knowledge of the future) and *explicit* (its expression is fully computable). For additional properties, see [1].

1. WELL POSEDNESS

Throughout, we denote by $\overline{B_{\mathbb{R}^m}(u, U)}$ the closed ball in \mathbb{R}^m centered at u with radius U . Introduce $P \equiv (P_1, \dots, P_k)$, so that $P \in \mathbb{R}^m$ with $m = kN$. On the vector field v , we impose the following assumptions:

- (v): The vector field $v \in C^0([0, T] \times \mathbb{R}^N \times \mathbb{R}^m; \mathbb{R}^N)$ is such that
 - the map $x \mapsto v(t, x, P)$ is in $C^{1,1}(\mathbb{R}^N; \mathbb{R}^N)$ for all $t \in [0, T]$ and $P \in \mathbb{R}^m$;
 - the map $P \mapsto v(t, x, P)$ is in $C^{0,1}(\mathbb{R}^m; \mathbb{R}^N)$ for all $t \in [0, T]$ and $x \in \mathbb{R}^N$.

The i -th leader P_i seeks a control $u_i \in L^\infty([0, T]; \overline{B(0, U)})$ that minimizes the cost (2). In this part, we assume that each agent P_i knows in advance the strategies u_j , for $j \neq i$, of the other controllers P_j . Then, the existence of an optimal control follows thanks to the well posedness of (1).

Proposition 1. *Fix positive T and U . Let v be a vector field satisfying (v). For every $\bar{\rho} \in L^1(\mathbb{R}^N; \mathbb{R})$, $\bar{P} \in \mathbb{R}^m$ and $u \in L^\infty([0, T]; \overline{B_{\mathbb{R}^m}(0, U)})$, problem (1) admits a unique solution. Moreover, if $u_1, u_2 \in L^\infty([0, T]; \overline{B_{\mathbb{R}^m}(0, U)})$, then (with obvious notation) for all $t \in [0, T]$,*

$$\begin{aligned} \|\rho_1(t) - \rho_2(t)\|_{L^1(\mathbb{R}^N; \mathbb{R})} &\leq C \left(\|\nabla_x \bar{\rho}\|_{L^\infty(\mathbb{R}^N; \mathbb{R}^N)} \mathcal{L}^N(B(\text{spt}(\bar{\rho}), Cte^{Ct})) \right. \\ &\quad \left. + \|\bar{\rho}\|_{L^1(\mathbb{R}^N; \mathbb{R})} (1 + Ct) \right) t e^{2Ct} \|P_1 - P_2\|_{C^0([0, t]; \mathbb{R}^m)} \end{aligned}$$

where C is independent of $\bar{\rho}$ and \mathcal{L}^N denotes the Lebesgue measure on \mathbb{R}^N .

The existence of optimal controls easily follows.

Proposition 2. *Fix $i \in \{1, \dots, k\}$, positive T and U , and initial conditions $\bar{P} \in \mathbb{R}^m$ and $\bar{\rho} \in L^1(\mathbb{R}^N; \mathbb{R})$ with compact support. Let v be a vector field satisfying (v). If $u_j \in L^\infty([0, T]; \overline{B(0, U)})$ for $j \in \{1, \dots, k\} \setminus \{i\}$ and $\psi_i \in L^\infty_{loc}(\mathbb{R}^N; \mathbb{R})$, then, calling ρ the solution to (1), the map*

$$(3) \quad \begin{array}{ccc} \mathcal{J}_i : L^\infty([0, T]; \overline{B(0, U)}) & \longrightarrow & \mathbb{R} \\ u_i & \longmapsto & \int_{\mathbb{R}^N} \rho(T, x) \psi_i(x) dx \end{array}$$

is weak* sequentially continuous in L^∞ and there exists an optimal control u_i^* minimizing \mathcal{J}_i .

The approach on which Proposition 2 is based can hardly be used in a game theoretic setting. Indeed, the possible necessary conditions for a control u^* to minimize \mathcal{J}_i in (3) could not be used in a game theoretic setting. Such conditions would require that P_i is aware of all other strategies u_j , $j \neq i$, on the whole time interval $[0, T]$. This ability to foresee the future choices of the competitors is unreasonable whenever different agents are confronting with each other.

2. A NON ANTICIPATE STRATEGY

In this section, we present a strategy for the controllers, which is non anticipate, i.e. it does not require the knowledge of the future. To this aim, always considering an arbitrary number of controllers, we fix our attention on a specific controller P_i and, for simplicity, we simplify the notation, setting $P = P_i$, $u = u_i$, $\mathcal{J} = \mathcal{J}_i$ and comprising within the time dependence of the function v all the other strategies u_j , for $j \neq i$. In this way we obtain the problem

$$(4) \quad \begin{cases} \partial_t \rho + \text{div}_x(\rho v(t, x, P(t))) = 0 \\ \rho(0, x) = \bar{\rho}(x) \end{cases} \quad \text{where} \quad \begin{cases} \dot{P} = u(t) \\ P(0) = \bar{P}. \end{cases}$$

For a positive (suitably small) Δt , we seek the best choice of a speed $w \in \overline{B(0, U)}$ on the interval $[t, t + \Delta t]$ such that the solution $\rho_w = \rho_w(\tau, x)$ to

$$(5) \quad \begin{cases} \partial_\tau \rho_w + \operatorname{div}_x (\rho_w v(t, x, P(t) + (\tau - t)w)) = 0 \\ \rho_w(t, x) = \rho(t, x) \end{cases} \quad \tau \in [t, t + \Delta t]$$

is likely to best contribute to decrease the value of \mathcal{J} or, more precisely, of

$$(6) \quad \begin{aligned} \mathcal{J}_{t, \Delta t} : \mathbb{R}^N &\longrightarrow \mathbb{R} \\ w &\longmapsto \int_{\mathbb{R}^N} \rho_w(t + \Delta t, x) \psi(x) dx \end{aligned}$$

see also [2, 3]. The main result is the following one; see [1].

Theorem 1. *Let v be a vector field satisfying (v). Fix $T > 0$, $U > 0$, and $\psi \in L^\infty(\mathbb{R}^N; \mathbb{R})$. As initial data in (4), choose a boundedly supported $\bar{\rho} \in L^1(\mathbb{R}^N; \mathbb{R})$ and a $\bar{P} \in \mathbb{R}^N$. Define ρ as the solution to (4) and ρ_w as the solution to (5), for $w \in \overline{B(0, U)}$. Then, for every $t \in [0, T[$ and $\Delta t \in]0, T - t]$, the map (6) is well defined and Lipschitz continuous. Moreover if $v \in C^2([0, T] \times \mathbb{R}^N \times \mathbb{R}^m; \mathbb{R}^N)$, then the map (6) admits the Taylor expansion*

$$(7) \quad \mathcal{J}_{t, \Delta t}(w + \delta_w) = \mathcal{J}_{t, \Delta t}(w) + \nabla_w \mathcal{J}_{t, \Delta t}(w) \cdot \delta_w + o(\delta_w) \quad \text{as } \delta_w \rightarrow 0$$

where, as $\Delta t \rightarrow 0$,

$$(8) \quad \begin{aligned} \nabla_w \mathcal{J}_{t, \Delta t}(w) &= \frac{(\Delta t)^2}{2} \int_{\mathbb{R}^N} \nabla_x \rho(t, x) D_P v(t, x, P(t)) \psi(x) dx \\ &\quad - \frac{(\Delta t)^2}{2} \int_{\mathbb{R}^N} \rho(t, x) \nabla_P \operatorname{div}_x v(t, x, P(t)) \psi(x) dx + o(\Delta t)^2. \end{aligned}$$

On the basis of Theorem 1, the definition of an effective non anticipative or myopic strategy for P_i can be achieved as follows. Split the time interval $[0, T]$ in smaller portions $[t_\ell, t_{\ell+1}[$, where $t_\ell = \ell \Delta t$. On each of them, define the control $u_i(t) = w_\ell$, where w_ℓ minimizes on $\overline{B(0, U)}$ the cost functional $\mathcal{J}_{t_\ell, \Delta t}$ defined in (6). The leading term in the right hand side of (8) is independent of w , so that for Δt small it is reasonable to choose $-w_\ell$ as

$$\frac{U \int_{\mathbb{R}^N} \left[\nabla_x \rho(t_\ell, x) D_P v(t_\ell, x, P_i(t_\ell)) - \rho(t_\ell, x) \nabla_P \operatorname{div}_x v(t_\ell, x, P_i(t_\ell)) \right] \psi(x) dx}{\left\| \int_{\mathbb{R}^N} \left[\nabla_x \rho(t_\ell, x) D_P v(t_\ell, x, P_i(t_\ell)) - \rho(t_\ell, x) \nabla_P \operatorname{div}_x v(t_\ell, x, P_i(t_\ell)) \right] \psi(x) dx \right\|}$$

as long as the denominator above does not vanish, in which case we set $w_\ell = 0$. Remark that, through the term ρ_ℓ , the right hand side above depends on all the past values $w_0, \dots, w_{\ell-1}$ attained by u_i .

REFERENCES

- [1] R. M. Colombo, M. Garavello, *Hyperbolic Consensus Games*, CMS, to appear.
- [2] M. Hinze, *Instantaneous closed loop control of the Navier-Stokes system*. *SIAM J. Control Optim.*, 44(2):564–583, 2005.
- [3] D. Q. Mayne, H. Michalska, *Receding horizon control of nonlinear systems*, *IEEE Trans. Automat. Control*, 35(7):814–824, 1990.

Relative Entropy for Isothermal Euler Equations on Networks

JAN GIESSELMANN

(joint work with Raul Borsche)

The simulation of gas flows on networks has attracted a lot of attention in recent years. The increased interest in this field stems from (at least) two sources: Firstly, from political decisions to increase the use of renewable energies whose availability at any given time is, at least at the moment, fairly uncertain so that they need to be combined with other forms of power plants that are available at short notice. Secondly, the liberalization of the European gas market has increased pressure on gas suppliers for optimizing their operation of gas networks.

There is a wide variety of available models for gas networks [4] and we will focus on (by the standards of the field) rather complex models, i.e. models describing the networks as a graph consisting of edges and nodes: On each edge a 1-dimensional PDE is considered and these are coupled by algebraic conditions at the nodes. To be more precise, we consider the 1-dimensional isothermal or isentropic Euler equations with friction on each pipe:

$$(1) \quad \begin{aligned} \partial_t \rho_i + \partial_x(\rho_i v_i) &= 0 \\ \partial_t(\rho_i v_i) + \partial_x(\rho_i v_i^2 + p(\rho_i)) &= -\lambda \rho_i v_i \end{aligned} \quad \text{in } (0, L_i) \times (0, T),$$

where ρ denotes density, v denotes velocity, p denotes a pressure law, i.e., $p(\rho) = a\rho$ with $a > 0$ or $p(\rho) = a\rho^\gamma$ with $a > 0$, $\gamma > 1$, $\lambda > 0$ is a friction coefficient, $L > 0$ is length of a pipe and \cdot_i denotes quantities on the i -th pipe.

Coupling conditions at the nodes for gas networks have been discussed by several authors [1, 6].

The system (1) is a system of hyperbolic conservation laws and for such systems the relative entropy method has reached a somewhat mature state. Let us mention that it can be used for providing a posteriori error estimates for numerical schemes [3] and to determine diffusive limits [5]. However, albeit the mentioned maturity, usually problems on the whole space \mathbb{R}^n or on the torus are considered. Our goal is to extend the relative entropy methodology to gas networks and to this end we restrict ourselves to a specific set of coupling conditions, the energy consistent coupling suggested by Reigstad [6]. In order to state the coupling conditions, let \mathcal{I}_n denote the set of all pipes adjacent to some node n :

Conservation of mass at the node amounts to

$$(2) \quad \sum_{i \in \mathcal{I}_n} a_i \rho_i v_i = 0,$$

with $a_i \in \{-1, 1\}$ depending on the orientation of the pipe. In addition, Reigstad [6] suggests continuity of enthalpy, i.e.

$$(3) \quad h'(\rho_i) + \frac{1}{2}|v_i|^2 = h'(\rho_j) + \frac{1}{2}|v_j|^2 \quad \forall i, j \in \mathcal{I}_n,$$

where $h = h(\rho)$ denotes internal energy density which is related to pressure via

$$\rho h''(\rho) = p'(\rho).$$

On each pipe there is an energy balance law

$$\partial_t \left(h(\rho_i) + \frac{1}{2} \rho_i |v_i|^2 \right) + \partial_x \left(\rho_i v_i \left(h'(\rho_i) + \frac{1}{2} |v_i|^2 \right) \right) = -\rho_i |v_i|^2$$

and the coupling conditions ensure that the sum of energy fluxes at each node vanishes

$$\sum_{i \in \mathcal{I}_n} a_i \rho_i v_i \left(h'(\rho_i) + \frac{1}{2} |v_i|^2 \right) = \left(h'(\rho_1) + \frac{1}{2} |v_1|^2 \right) \sum_{i \in \mathcal{I}_n} a_i \rho_i v_i = 0.$$

Lemma 1 (Reigstad). *For smooth solutions of (1), (2), (3) on closed networks energy is only dissipated via friction in the pipes:*

$$\frac{d}{dt} \left(\sum_i \int_0^{L_i} h(\rho_i) + \frac{1}{2} \rho_i |v_i|^2 \, dx \right) = -\lambda \sum_i \int_0^{L_i} \rho_i |v_i|^2 \, dx.$$

The natural way to set up a relative entropy framework would be to define

$$\begin{aligned} u &:= \begin{pmatrix} \rho \\ \rho v \end{pmatrix}, & f(u) &:= \begin{pmatrix} \rho v \\ \rho v^2 + p(\rho) \end{pmatrix}, \\ \eta(u) &:= h(\rho) + \frac{1}{2} \rho |v|^2, & q(u) &:= \rho v \left(h'(\rho) + \frac{1}{2} |v|^2 \right). \end{aligned}$$

Let us remark that in isentropic flows the mathematical entropy η is indeed the (physical) energy. Then, given states u, \bar{u} the relative entropy and the relative entropy flux between them are defined as

$$\begin{aligned} \eta(u|\bar{u}) &:= \eta(u) - \eta(\bar{u}) - \nabla_u \eta(\bar{u})(u - \bar{u}), \\ q(u|\bar{u}) &:= q(u) - q(\bar{u}) - \nabla_u \eta(\bar{u})(f(u) - f(\bar{u})). \end{aligned}$$

Given two smooth solutions $\{(\rho_i, \rho_i v_i)\}_i = \{u_i\}_i$ and $\{(\bar{\rho}_i, \bar{\rho}_i \bar{v}_i)\}_i = \{\bar{u}_i\}_i$ of (1) the following holds on every pipe:

$$(4) \quad \partial_t \eta(u_i|\bar{u}_i) + \partial_x q(u_i|\bar{u}_i) = -\partial_x (\nabla_u \eta(\bar{u}_i)) f(u_i|\bar{u}_i) - \rho_i (v_i - \bar{v}_i)^2,$$

where we have used the specific form of the friction term on the right hand side.

Formally, we can try to obtain relative entropy estimates by integrating (4) on each pipe and summing over all pipes. We obtain

$$\begin{aligned} \frac{d}{dt} \sum_i \int_0^{L_i} \eta(u_i|\bar{u}_i) \, dx + \sum_i \int_0^{L_i} \rho_i (v_i - \bar{v}_i)^2 \, dx \\ = - \sum_i \int_0^{L_i} \partial_x (\nabla_u \eta(\bar{u}_i)) f(u_i|\bar{u}_i) \, dx - \lambda \sum_n \sum_{i \in \mathcal{I}_n} a_i q(u_i|\bar{u}_i) \end{aligned}$$

but it turns out that (2),(3) do not allow us to control the sum of relative entropy fluxes at the nodes.

Indeed, the relative entropy fluxes at the nodes depend on traces of the solutions at the nodes, i.e. they cannot be controlled by integrals of relative entropies on the pipes. This can be seen as a major obstacle to setting up a relative entropy framework for isothermal/isentropic Euler equations on networks. However, this

obstacle can be overcome – to a certain extent – by rewriting (1) as a system of conservation laws in (ρ, v) , i.e.,

$$(5) \quad \begin{aligned} \partial_t \rho_i + \partial_x(\rho_i v_i) &= 0 \\ \partial_t v_i + \partial_x \left(\frac{1}{2} v_i^2 + h'(\rho_i) \right) &= -\lambda v_i \end{aligned} \quad \text{in } (0, L_i) \times (0, T).$$

We would like to mention that strong vacuum-free solutions of (1) solve (5) and vice-versa but it does not make sense to consider weak solutions of (5), since there is no 'conservation of velocity' principle.

If the relative entropy framework is set up in (ρ, v) -variables the relative entropy fluxes at the nodes add up to zero. A proof of this can be found in [2]. This allows us to obtain standard results from relative entropy analysis, e.g. a posteriori error estimates for numerical schemes and convergence rates toward diffuse (large friction) limits.

However, it needs to be mentioned that these estimates can only be obtained under two conditions that are usually not present in classical relative entropy results:

- Both solutions (that are compared by relative entropy) need to be strong solutions, since weak solutions to (1) and (5) are not the same.
- Both solutions (that are compared by relative entropy) need to be subsonic since the energy η is only convex in (ρ, v) for subsonic states, i.e., states satisfying $|v| < p'(\rho)$.

REFERENCES

- [1] M.K. Banda, M. Herty, A. Klar, *Coupling conditions for gas networks governed by the isothermal Euler equations*, Netw. Heterog. Media **1** (2006), no. 1, 41–56.
- [2] R. Borsche, J. Giesselmann, *A posteriori error analysis of DG approximations of isentropic Euler equations on networks*, In preparation.
- [3] A. Dedner, J. Giesselmann, *A posteriori analysis of fully discrete method of lines discontinuous Galerkin schemes for systems of conservation laws*, SIAM J. Numer. Anal. **54** (2016), no. 6, 3523–3549.
- [4] P. Domschke, A. Dua, J. Stolwijk, J. Lang, and V. Mehrmann, *Adaptive refinement strategies for the simulation of gas flow in networks using a model hierarchy*, Electron. Trans. Numer. Anal. **48** (2018), 97–113.
- [5] C. Lattanzio, A. E. Tzavaras, *From gas dynamics with large friction to gradient flows describing diffusion theories*, Comm. Partial Differential Equations **42** (2017), no. 2, 261–290.
- [6] G. A. Reigstad, *Numerical network models and entropy principles for isothermal junction flow*, Netw. Heterog. Media **9** (2014), no. 1, 65–95.

Regularity Results for the Solutions of a Non-Local Model of Traffic Flow

PAOLA GOATIN

(joint work with Florent Berthelin)

We consider the non-local scalar conservation law introduced in [2] to model traffic flow accounting for the reaction of drivers to downstream traffic conditions:

$$(1) \quad \partial_t \rho(t, x) + \partial_x (\rho(t, x) v((\rho * \omega)(t, x))) = 0, \quad x \in \mathbb{R}, t > 0,$$

where

$$(2) \quad (\rho * \omega)(t, x) = \int_0^\eta \rho(t, x + y) \omega(y) dy = \int_x^{x+\eta} \rho(t, y) \omega(y - x) dy.$$

We make the following assumptions for $k = 1, 2, 3$:

(\mathbf{A}_ω^k) $\omega \in \mathbf{C}^k([0, \eta])$ is non-negative with support in $[0, \eta]$ and is non-increasing on $[0, \eta]$.

(\mathbf{A}_v^k) $v \in \mathbf{C}^k(\mathbb{R}^+)$ with $v, v', \dots, v^{(k)}$ bounded.

Equation (1) is coupled with an initial condition

$$(3) \quad \rho(0, t) = \rho^0(x), \quad x \in \mathbb{R}, \quad \text{with } \rho^0 \in \mathbf{L}^\infty(\mathbb{R}) \cap \mathbf{L}^1(\mathbb{R}).$$

In general, solutions to non-local equations may be discontinuous [5], despite the expected regularizing effect of the convolution product. Therefore, the solutions to the Cauchy problem for (1) are usually intended in the following weak form:

Definition 1. A function $\rho \in (\mathbf{L}^\infty \cap \mathbf{L}^1)(\mathbb{R}^+ \times \mathbb{R})$ is a solution of (1)–(3) if

$$(4) \quad \int_0^{+\infty} \int_{-\infty}^{+\infty} (\rho \partial_t \varphi + \rho v(\rho * \omega) \partial_x \varphi)(t, x) dx dt + \int_{-\infty}^{+\infty} \rho^0(x) \varphi(0, x) dx = 0,$$

for all $\varphi \in \mathbf{C}_c^\infty(\mathbb{R}^2)$.

Remark 1. Note that here we are not requiring $v' \leq 0$, which is a mandatory assumption in traffic flow modeling, guaranteeing that the solution stays bounded below the maximal density $R > 0$, such that $v(R) = 0$. More precisely, the following strong maximum principle is proved in [2]:

$$\min_{x \in \mathbb{R}} \rho^0(x) \leq \rho(t, x) \leq \max_{x \in \mathbb{R}} \rho^0(x), \quad \text{a.e. } x \in \mathbb{R}.$$

On the contrary, if v is not non-increasing, the solution can exhibit blow-up in finite time. Let us take for example $\omega = \chi_{[0,1]}$, $v(\rho) = \rho$ and $\rho^0 = \chi_{[0,1]}$. The support of $\rho(t, \cdot)$ is then contained in $[a(t); 0]$, with $a(t) = -1 + t$ for $t \in [0, 1[$. By mass conservation $\int_{\mathbb{R}} \rho(t, x) dx \equiv 1$, for $t \geq 0$, we deduce that $\|\rho(t, \cdot)\|_{\mathbf{L}^\infty} \geq (1 - t)^{-1}$, which implies $\|\rho(t, \cdot)\|_{\mathbf{L}^\infty} \rightarrow +\infty$ for $t \nearrow 1$, see [4, Remark 3.2].

In this talk, we are interested in deriving regularity properties of solutions to (1)–(3). To this end, we will consider approximate solutions satisfying the

viscous and regularized non-local equation (see [3] for a similar regularization analysis)

$$(5) \quad \partial_t \rho_\varepsilon + \partial_x (\rho_\varepsilon v(\rho_\varepsilon * \omega_\varepsilon)) = \varepsilon \partial_{xx}^2 \rho_\varepsilon,$$

where, for any $\varepsilon > 0$, the smooth function ω_ε is an extension of ω with the following regularities:

($\mathbf{A}_{\omega_\varepsilon}^k$) $\omega_\varepsilon \in \mathbf{C}^k(\mathbb{R})$ is non-negative with a support in $[-\varepsilon, \eta + \varepsilon]$, is non-decreasing on $[-\varepsilon, x_\varepsilon]$, for some $x_\varepsilon \in]-\varepsilon, 0]$, is non-increasing on $[x_\varepsilon, \eta + \varepsilon]$ and $\omega_\varepsilon = \omega$ on $[0, \eta]$. We set $W_\varepsilon := \omega_\varepsilon(x_\varepsilon)$ and we assume that $\lim_{\varepsilon \rightarrow 0} W_\varepsilon = \omega(0)$. Without loss of generality we can assume

$$W_\varepsilon \leq 2\omega(0).$$

($\mathbf{B}_{\omega_\varepsilon}^k$) $\omega_\varepsilon^{(j)}(-\varepsilon) = \omega_\varepsilon^{(j)}(\eta + \varepsilon) = 0$ for $j = 1, \dots, k$ and $|\omega_\varepsilon'(u)| \leq 2W_\varepsilon/\varepsilon$ on $[-\varepsilon, 0]$ and $|\omega_\varepsilon'(u)| \leq 2\omega(\eta)/\varepsilon$ on $[\eta, \eta + \varepsilon]$.

We can prove the following result.

Theorem 1. *We assume (\mathbf{A}_ω^2)-(\mathbf{A}_v^3). Let ρ_ε be smooth solution of (5) with initial datum $\rho^0 \in \mathbf{W}^{1,4}(\mathbb{R}) \cap \mathbf{H}^2(\mathbb{R})$. Then, for $T > 0$ sufficiently small, ρ_ε converges in $\mathbf{L}_{\text{loc}}^2([0, T] \times \mathbb{R})$ to a solution $\rho \in \mathbf{C}([0, T], \mathbf{L}^2(\mathbb{R}))$ to equation (1) with initial datum ρ^0 . Furthermore, if $\rho^0 \in \mathbf{W}^{1,2N}(\mathbb{R})$, $N \in \mathbb{N}^*$, then $\rho \in \mathbf{W}^{1,2N}([0, T] \times \mathbb{R})$, and if $\rho^0 \in \mathbf{W}^{1,4N}(\mathbb{R}) \cap \mathbf{H}^1(\mathbb{R}) \cap \mathbf{W}^{2,2N}(\mathbb{R})$, then $\rho \in \mathbf{W}^{2,2N}([0, T] \times \mathbb{R})$.*

The proof consists of the following steps: We first establish estimates on the non-local term and we derive $\mathbf{L}^p(\mathbb{R})$, $p > 1$, estimates for ρ_ε , then we get estimates in $\mathbf{W}^{1,2N}(\mathbb{R})$ for ρ_ε with respect to x . This allows to prove that there exists $T > 0$ such that the sequence ρ_ε is uniformly bounded with respect to ε in $\mathbf{L}^\infty(\mathbb{R})$ on $[0, T]$. Then we prove uniform space estimates in $\mathbf{W}^{2,2N}(\mathbb{R})$ for ρ_ε , which allows to derive estimates on $\partial_t \rho_\varepsilon$. The interested reader can find the details in [1].

REFERENCES

- [1] F. Berthelin and P. Goatin. Regularity results for the solutions of a non-local model of traffic. *Discrete Contin. Dyn. Syst. Ser. A*, 39(6):3197–3213, 2019.
- [2] S. Blandin and P. Goatin. Well-posedness of a conservation law with non-local flux arising in traffic flow modeling. *Numer. Math.*, 132(2):217–241, 2016.
- [3] M. Colombo, G. Crippa and L.V. Spinolo. On the singular local limit for conservation laws with nonlocal fluxes *Arch. Rational Mech. Anal.*, 2019.
- [4] P. Goatin and F. Rossi. A traffic flow model with non-smooth metric interaction: well-posedness and micro-macro limit. *Comm. Math. Sci.*, 15(1):261–287, 2017.
- [5] D. Li and T. Li. Shock formation in a traffic flow model with Arrhenius look-ahead dynamics. *Networks and Heterogeneous Media*, 6(4):681–694, 2011.

Backward Euler Approximations for Conservation Laws with Discontinuous Fluxes

GRAZIANO GUERRA

(joint work with Alberto Bressan, Wen Shen)

We construct solutions to a class of one dimensional conservation laws with discontinuous flux

$$(1) \quad \begin{cases} u_t + f(x, u)_x = 0, \\ u(0, x) = \bar{u}(x) \in \mathbf{L}^1(\mathbb{R}, \mathbb{R}), \end{cases} \quad f(x, \omega) = \begin{cases} f^L(\omega), & \text{if } x < 0 \\ f^R(\omega), & \text{if } x > 0 \end{cases},$$

with $f^L(0) = f^R(0) = 0$, $f^L(1) = f^R(1)$, relying on the Crandall-Liggett theory of nonlinear contractive semigroups [3, 4], with a vanishing viscosity approach.

Cauchy problem (1) can be written as a Cauchy problem for an autonomous 2×2 system:

$$\begin{cases} a_t & = 0 \\ u_t + F(a, u)_x & = 0, \end{cases} \quad a(0, x) = \begin{cases} 0 & \text{if } x < 0 \\ 1 & \text{if } x > 0, \end{cases} \quad u(0, x) = \bar{u}(x)$$

with $F(\alpha, \omega) = \alpha f^R(\omega) + (1 - \alpha) f^L(\omega)$. The eigenvalues and eigenvectors of the Jacobian of the flux of the 2×2 system are given by

$$\lambda_1 = 0, \quad r_1 = \begin{pmatrix} -F_\omega \\ F_\alpha \end{pmatrix}; \quad \lambda_2 = F_\omega, \quad r_2 = \begin{pmatrix} 0 \\ 1 \end{pmatrix}.$$

Therefore whenever $F_\omega = \alpha f_\omega^R + (1 - \alpha) f_\omega^L$ vanishes, the system is no more hyperbolic. It means that scalar conservation laws with discontinuous non homogeneous fluxes are an example of autonomous hyperbolic systems with regions in which hyperbolicity is lost.

This implies that the standard bounds on the spatial total variation of approximated solutions, usually effective in the theory of hyperbolic conservation laws, are lost [10]. As a consequence one cannot rely on the standard BV compactness arguments. Moreover, when actual solutions are shown to exist, they may not have bounded total variation. This poses some difficulties in showing the uniqueness of the solution and consequently the well posedness of the problem since commonly used arguments make use of conditions on traces [1, 6, 9].

These difficulties have been overcome by using more or less sophisticated techniques such as the singular mapping [10], compensated compactness [7] and the theory of traces for entropy solution to conservation laws [8].

We are interested in a different approach that neglects the Riemann problem, BV estimates and traces of solutions. It gives directly the strong convergence of viscous approximations u^ε , solutions to

$$(2) \quad \begin{cases} u_t^\varepsilon + f(x, u^\varepsilon)_x = \varepsilon u_{xx}^\varepsilon, \\ u(0, x) = \bar{u}(x) \in \mathbf{L}^1(\mathbb{R}, \mathbb{R}), \end{cases}$$

to a unique limit u , solution to (1). This result can be used as a building block to prove uniqueness of the vanishing viscosity limit for very general discontinuous fluxes [2]. The solutions to the corresponding viscous conservation laws (2) are studied using Backward Euler approximations according to the following two classical theorems in non linear functional analysis.

Given a (possibly non linear) map $A : \mathcal{D}(A) \subset X \rightarrow X$ defined on a subset $\mathcal{D}(A)$ of a Banach space X , the resolvent operator is defined as $J_\lambda = (I + \lambda A)^{-1}$ for any $\lambda > 0$. We say that A is **accretive** if for all $\lambda > 0$, $u_1, u_2 \in \mathcal{D}(A)$, the inequality $\|(u_1 + \lambda Au_1) - (u_2 + \lambda Au_2)\| \geq \|u_1 - u_2\|$ holds, i.e. if J_λ is a **contraction**.

Theorem 1. [4, Theorem I] *Let A be an accretive operator on the Banach space X , and J_λ be the corresponding Backward-Euler operator (plus some hypotheses on the domains), then for every initial datum $\bar{u} \in \overline{\mathcal{D}(A)}$ and every $t \geq 0$ the limit*

$$S_t \bar{u} \doteq \lim_{n \rightarrow \infty} \left(J_{\frac{t}{n}} \right)^n \bar{u} \quad \text{is well defined}$$

and the family of operators $\{S_t; t \geq 0\}$ is a continuous semigroup of **contractions** on the set $\overline{\mathcal{D}(A)}$.

Theorem 2. [3, Theorem 3.1] *Let A, A^ε be accretive operators, $J_\lambda, J_\lambda^\varepsilon$ be the corresponding resolvent operators and S, S^ε be the corresponding generated semigroups (plus some hypotheses on the domains). If $\lim_{\varepsilon \rightarrow 0} J_\lambda^\varepsilon u = J_\lambda u$ holds for any $u \in \bar{D}$ and $\lambda > 0$, where \bar{D} is a suitably defined common domain, then the generated semigroups satisfy $\lim_{\varepsilon \rightarrow 0} S_t^\varepsilon u = S_t u$ for any $u \in \bar{D}$ and $t \geq 0$, in the strong topology of the Banach space and the limit is uniform for t in bounded intervals.*

To apply these theorems to our vanishing viscosity problem, we consider the domains $\mathcal{D}(A^\varepsilon) = \{u \in \mathbf{L}^1(\mathbb{R}, \mathbb{R}) : [f(x, u) - \varepsilon u_x]_x \in \mathbf{L}^1(\mathbb{R}, \mathbb{R})\}$ and the maps $A^\varepsilon u = [f(x, u) - \varepsilon u_x]_x$ defined for all $u \in \mathcal{D}(A^\varepsilon)$. The resolvent equation $u + \lambda A^\varepsilon u = w$ for A , i.e. the equation that defines the resolvent operator $u = J_\lambda^\varepsilon w = (I + \lambda A^\varepsilon)^{-1} w$, is the following ordinary differential equation

$$(3) \quad u^\varepsilon + \lambda [f(x, u^\varepsilon) - \varepsilon u_x^\varepsilon]_x = w.$$

In [5, Theorem 3.5] it is proved that for any $w \in \mathbf{L}^1(\mathbb{R}, \mathbb{R})$ there is a **unique** solution $u = J_\lambda^\varepsilon w$ to the resolvent equation (3) and moreover J_λ^ε turns out to be a family of contraction. This implies that A^ε is a family of **accretive** operators that generate a family of semigroups of contractions S_t^ε defined on $\mathbf{L}^1(\mathbb{R}, \mathbb{R})$ whose trajectories $S_t^\varepsilon \bar{u}$ are mild solutions to (2) ([5, Theorem 3.6]).

The main idea is to take the limit as $\varepsilon \rightarrow 0$ in the ordinary differential equation (3) and then apply Theorem 2 instead of taking the limit directly in the partial differential equation (2). Indeed in [5, Theorem 4.5] it is proved that $u^\varepsilon = J_\lambda^\varepsilon w \rightarrow u \doteq J_\lambda w$ in \mathbf{L}^1 for any $w \in D$ as $\varepsilon \rightarrow 0$, where D is defined by

$$D \doteq \{w \in \mathbf{L}^1(\mathbb{R}, \mathbb{R}) : 0 \leq w \leq 1\}.$$

Moreover $J_\lambda : D \rightarrow D$ is proved to be the resolvent operator of a suitable defined accretive operator A . An application of Theorem 2 leads to the main theorem proved in [5].

Theorem 3. [5, Theorem 5.2] *The map A generates a unique continuous semigroup of contractions $S_t : D \rightarrow D$ whose trajectories are distributional solutions to*

$$u_t + [f(x, u)]_x = 0.$$

Moreover, let $S_t^\varepsilon : D \rightarrow D$ be the semigroup generated by A^ε whose trajectories are solutions to

$$u_t + [f(x, u) - \varepsilon u_x]_x = 0,$$

then the following limit holds for all $\bar{u} \in D$ uniformly on bounded t intervals.

$$S_t \bar{u} = \lim_{\varepsilon \rightarrow 0} S_t^\varepsilon \bar{u}.$$

REFERENCES

- [1] B. Andreianov, K. H. Karlsen, and N. H. Risebro. “A theory of L^1 -dissipative solvers for scalar conservation laws with discontinuous flux”. *Arch. Rat. Mech. Anal.* **201** (2011), 27–86.
- [2] Alberto Bressan, Graziano Guerra and Wen Shen. “Vanishing Viscosity Solutions for Conservation Laws with Regulated Flux”. *J. Differential Equations* **266** (2019), 312–351.
- [3] H. Brézis and A. Pazy, “Convergence and approximation of semigroups of nonlinear operators in Banach spaces”. *J. Functional Analysis* **9** (1972), 63–74.
- [4] M. G. Crandall and T. M. Liggett, “Generation of semi-groups of nonlinear transformations on general Banach spaces”, *Amer. J. Math.*, **93** (1971), 265–298.
- [5] G. Guerra and W. Shen. “Backward Euler Approximations for Conservation Laws with Discontinuous Flux”. Preprint 2018. Accepted for publication in *SIAM J. Math. Anal.*, 2019.
- [6] Graziano Guerra and Wen Shen. “Vanishing Viscosity Solutions of Riemann Problems for Models of Polymer Flooding”. *Non-linear partial differential equations, mathematical physics, and stochastic analysis*, 261–285, EMS Congress Report (2018).
- [7] E. Yu. Panov “Existence and strong pre-compactness properties for entropy solutions of a first-order quasilinear equation with discontinuous flux”. *Arch. Ration. Mech. Anal.*, **195**. (2010), 643–673.
- [8] E. Yu. Panov “Existence of strong traces for quasi-solutions of multidimensional conservation laws”. *J. Hyperbolic Differ. Equ.*, **4**. (2007), 729–770.
- [9] Wen Shen. “On the Uniqueness of Vanishing Viscosity Solutions for Riemann Problems for Polymer Flooding”. *NoDEA* **24** (2017), no. 4, 2280–2316.
- [10] B. Temple “Global solution of the Cauchy problem for a class of 2×2 nonstrictly hyperbolic conservation laws”. *Adv. in Appl. Math.*, **3**. (1982), 335–375.

Stochastic Galerkin Formulations for Hyperbolic Conservation Laws

MICHAEL HERTY AND STEPHAN GERSTER

Recently, representation of stochastic processes by orthogonal polynomials has gained interest in the mathematical and engineering community. Whereas non-intrusive methods compute the statistics of interest directly using Monte-Carlo methods and numerical quadrature, intrusive methods substitute generalized polynomial chaos (gPC) expansions of the stochastic input in the governing equations. In the nonlinear case the expansion is projected to obtain deterministic evolution

equations for the gPC modes. A stochastic process $y(t, x; \xi)$ fulfilling the nonlinear hyperbolic system $\partial_t y(t, x; \xi) + \partial_x f(y(t, x; \xi)) = 0$ is expanded in the random variable ξ in a base of orthonormal polynomials $\xi \mapsto \phi_k(\xi)$ for $k = 0, \dots, K$. The gPC modes can be obtained by solving the system

$$(1) \quad \frac{\partial}{\partial t} \hat{y}_k(t, x) + \frac{\partial}{\partial x} \mathbb{E} \left[f(\mathcal{G}[y](t, x; \xi)) \phi_k(\xi) \right] = 0,$$

$$\text{for } \mathcal{G}[y](t, x; \xi) := \sum_{k=0}^K \hat{y}_k(t, x) \phi_k(\xi).$$

Next, we analyse the properties of gPC expanded systems. The deterministic isothermal Euler equations are *strictly* hyperbolic with *distinct* eigenvalues. This implies for the Jacobian of the flux function that there exists a *complete* set of eigenvectors. Such systems are called *strongly* hyperbolic. In contrast, the resulting system (1), denoted as $\hat{y}_t + \hat{f}(\hat{y})_x = 0$, is in general *not* hyperbolic [1, 3]. Hyperbolicity can be guaranteed for scalar equations, linear or quasilinear systems. Still, eigenvalues may coincide and hence, the existence of a complete set of eigenvectors is not guaranteed. Systems that are endowed with an entropy-entropy flux pair that satisfies the inequality $\eta(y)_t + \mu(y)_x \leq 0$, where $\eta(y)$ is a convex function, are symmetrizable. Then, for smooth solutions the system is equivalent to $H_y \eta(y) y_t + S(y) y_x = 0$, where the Hessian $H_y \eta(y)$ is strictly positive definite and the matrix $S(y) := H_y \eta(y) D_y f(y)$ is symmetric. Expansions in the entropy variables $\nabla_y \eta(y)$ yield symmetric and hence strongly hyperbolic quasilinear forms. To obtain a conservative formulation, however, expensive transforms must be computed [1].

For the full and the isothermal Euler equations an expansion in Roe variables allows to express nonlinear terms as quadratic terms [4]. The conserved variables $y := (\rho, q)^T$ of isothermal Euler equations are density and momentum, water height for shallow water equations, respectively. Roe variables $\omega := (\alpha, \beta)^T \in \mathbb{R}^+ \times \mathbb{R}$ are defined such that $\alpha^2 = \rho$, $\alpha\beta = q$. In particular, the nonlinearity in the flux function is expressed by the quadratic relation $q^2/\rho = \beta^2$.

Using numerical quadrature, we precompute the matrices

$$\mathcal{M}_k := (\mathbb{E}[\phi_i(\xi) \phi_j(\xi) \phi_k(\xi)])_{i,j=0,\dots,K}$$

and we express the Galerkin product by

$$(\hat{\alpha} * \hat{\beta})_k := \mathbb{E} \left[\left(\sum_{\ell=0}^K \hat{\alpha}_\ell(t, x) \phi_\ell(\xi) \right) \left(\sum_{\ell=0}^K \hat{\beta}_\ell(t, x) \phi_\ell(\xi) \right) \phi_k(\xi) \right]$$

$$= (\mathcal{P}(\hat{\alpha}) \hat{\beta})_k \quad \text{for } \mathcal{P}(\hat{\alpha}) = \sum_{k=0}^K \hat{\alpha}_k \mathcal{M}_k.$$

The mapping $\hat{\mathcal{Y}}(\hat{\omega}) = \hat{y}$ denotes the transform from Roe variables $\hat{\omega} := (\hat{\alpha}, \hat{\beta})^T$ to conserved variables $\hat{y} := (\hat{\rho}, \hat{q})^T$. To compute the Roe variables, we need to find the solution $\hat{\alpha} * \hat{\alpha} = \hat{\rho}$ for given $\hat{\rho} \in \mathbb{R}^{K+1}$. This problem, however, is in general

not well-posed. We define the convex function

$$\eta_{\hat{\rho}}(\hat{\alpha}) := \frac{\hat{\alpha}^T \mathcal{P}(\hat{\alpha}) \hat{\alpha}}{3} - \hat{\alpha}^T \hat{\rho}$$

on $\mathbb{H}^+ := \left\{ \hat{\alpha} \in \mathbb{R}^{K+1} \mid \mathcal{P}(\hat{\alpha}) \text{ is strictly positive definite} \right\}$.

The function admits a *unique* minimum on the convex, open set \mathbb{H}^+ , provided that it holds $\mathcal{G}[\alpha](t, x; x_k) > 0$ for all Gauss quadrature points x_k . Although the assumption of a strictly positive squared density can be weakend to a positive definiteness assumption, the expected density $\mathbb{E}[\rho] = \hat{\rho}_0 = (\hat{\alpha} * \hat{\alpha})_0 = \|\hat{\alpha}\|_2^2 > 0$ remains positive. We consider solutions in the open, admissible set

$$\mathbb{H} := \left\{ \hat{y} := (\hat{\rho}, \hat{q})^T \in (\mathbb{R}^+ \times \mathbb{R}^K) \times \mathbb{R}^{K+1} \mid \hat{\alpha} \in \mathbb{H}^+ \text{ for } (\hat{\alpha}, \hat{\beta})^T = \hat{\mathcal{Y}}^{-1}(\hat{y}) \right\},$$

where the matrix $\mathcal{P}_\nu(\hat{\omega}) := \mathcal{P}(\hat{\beta})\mathcal{P}^{-1}(\hat{\alpha})$ is well-defined. For particular wavelet-based gPC expansions, e.g. the Wiener-Haar expansion and linear multiwavelets [4],

- (A) there is an eigenvalue decomposition $\mathcal{P}(\hat{\alpha}) = V D_{\mathcal{P}}(\hat{\alpha}) V^T$
with constant eigenvectors.

For these expansions we have the following results from [6].

Theorem 1 (Shallow Water Equations). *For given admissible states $\hat{y} := (\hat{\rho}, \hat{q})^T \in \mathbb{H}$ we consider gPC bases under assumption (A). Then, a strongly hyperbolic stochastic Galerkin formulation for shallow water equations*

$$\begin{pmatrix} \rho \\ q \end{pmatrix}_t + \begin{pmatrix} q \\ \frac{q^2}{\rho} + \frac{g}{2}\rho^2 \end{pmatrix}_x = 0 \quad \text{reads} \quad \begin{pmatrix} \hat{\rho} \\ \hat{q} \end{pmatrix}_t + \begin{pmatrix} \hat{q} \\ \hat{\beta} * \hat{\beta} + \frac{g}{2}(\hat{\rho} * \hat{\rho}) \end{pmatrix}_x = 0.$$

The Jacobian of the flux function and its real eigenvalues are

$$D_{\hat{y}} \hat{f}(\hat{y}) = \begin{pmatrix} \mathbb{O} & \mathbb{1} \\ g\mathcal{P}(\hat{\rho}) - \mathcal{P}_\nu^2(\hat{\omega}) & 2\mathcal{P}_\nu(\hat{\omega}) \end{pmatrix}$$

and

$$\sigma \left\{ D_{\hat{y}} \hat{f}(\hat{y}) \right\} = D_{\mathcal{P}}(\hat{\beta}) D_{\mathcal{P}}^{-1}(\hat{\alpha}) \pm \sqrt{g} D_{\mathcal{P}}(\hat{\rho}) D_{\mathcal{P}}^{-1}(\hat{\alpha}).$$

An entropy is $\eta(\hat{y}) := \frac{g}{2} \|\hat{\rho}\|_2^2 + \frac{1}{2} \|\hat{\beta}\|_2^2$.

The entropy reduces in the deterministic case to the physically relevant entropy. It can also be used for error estimates based on the relative entropy framework [2, 6]. For isothermal Euler equations the following results are shown in [5].

Theorem 2 (Isothermal Euler Equations). *A strongly hyperbolic stochastic Galerkin formulation for isothermal Euler equations*

$$\begin{pmatrix} \rho \\ q \end{pmatrix}_t + \begin{pmatrix} q \\ \frac{q^2}{\rho} + a^2 \rho \end{pmatrix}_x = 0 \quad \text{reads} \quad \begin{pmatrix} \hat{\rho} \\ \hat{q} \end{pmatrix}_t + \begin{pmatrix} \hat{q} \\ \hat{\beta} * \hat{\beta} + a^2 \hat{\rho} \end{pmatrix}_x = 0$$

for states $\hat{y} := (\hat{\rho}, \hat{q})^T \in \mathbb{H}$. The Jacobian of the flux function and its real eigenvalues are

$$D_{\hat{y}}\hat{f}(\hat{y}) = \begin{pmatrix} \mathbb{O} & \mathbb{1} \\ a^2 - \mathcal{P}_\nu^2(\hat{\omega}) & 2\mathcal{P}_\nu(\hat{\omega}) \end{pmatrix} \quad \text{and} \quad \sigma\{D_{\hat{y}}\hat{f}(\hat{y})\} = D_\nu(\hat{\omega}) \pm a,$$

where $D_\nu(\hat{\omega})$ are the eigenvalues of the matrix $\mathcal{P}_\nu(\hat{\omega})$. Under assumption (A) the system is symmetrizable, i.e. the matrix $H(\hat{y})D_{\hat{y}}\hat{f}(\hat{y})$ is symmetric for the strictly positive definite matrix

$$H(\hat{y}) := \tilde{H}(\hat{Y}^{-1}[\hat{y}]) := \begin{pmatrix} \mathcal{P}^2(\hat{\beta})\mathcal{P}^{-4}(\hat{\alpha}) + a^2\mathcal{P}^{-2}(\hat{\alpha}) & -\mathcal{P}(\hat{\beta})\mathcal{P}^{-3}(\hat{\alpha}) \\ -\mathcal{P}(\hat{\beta})\mathcal{P}^{-3}(\hat{\alpha}) & \mathcal{P}^{-2}(\hat{\alpha}) \end{pmatrix}.$$

To approximate the solution by cell averages, we consider the local Lax-Friedrichs and Roe flux

$$(2) \quad \hat{\mathbf{f}}(\hat{\mathbf{y}}_\ell, \hat{\mathbf{y}}_r) = \frac{1}{2} [\hat{f}(\hat{\mathbf{y}}_\ell) + \hat{f}(\hat{\mathbf{y}}_r)] + \frac{1}{2} \max_{j=\ell,r} \left\{ \sigma \left\{ D_{\hat{y}}\hat{f}(\hat{y}) \Big|_{\hat{y}=\hat{\mathbf{y}}_j} \right\} \right\} (\hat{\mathbf{y}}_\ell - \hat{\mathbf{y}}_r),$$

$$(3) \quad \hat{\mathbf{f}}(\hat{\mathbf{y}}_\ell, \hat{\mathbf{y}}_r) = \frac{1}{2} [\hat{f}(\hat{\mathbf{y}}_\ell) + \hat{f}(\hat{\mathbf{y}}_r)] + \frac{1}{2} \hat{A}(\hat{\mathbf{y}}_\ell, \hat{\mathbf{y}}_r) (\hat{\mathbf{y}}_\ell - \hat{\mathbf{y}}_r),$$

where the Roe matrix \hat{A} has to satisfy $\hat{A}(\hat{\mathbf{y}}_\ell, \hat{\mathbf{y}}_r)(\hat{\mathbf{y}}_\ell - \hat{\mathbf{y}}_r) = \hat{f}(\hat{\mathbf{y}}_\ell) - \hat{f}(\hat{\mathbf{y}}_r)$, it is required to have real eigenvalues and $\hat{A}(\hat{\mathbf{y}}_\ell, \hat{\mathbf{y}}_r) \rightarrow D_{\hat{y}}\hat{f}(\hat{y})$ for $\hat{\mathbf{y}}_\ell, \hat{\mathbf{y}}_r \rightarrow \hat{y}$. Originally, Roe variables were introduced to construct this Roe matrix for the full Euler equations. Under assumption (A), the idea is extended to a stochastic Galerkin framework [4]. For isothermal Euler equations and arbitrary gPC bases the Jacobian

$$(4) \quad \hat{A}(\hat{\omega}_\ell, \hat{\omega}_r) := \begin{pmatrix} \mathbb{O} & \mathbb{1} \\ a^2 - \mathcal{P}_\nu^2(\bar{\omega}) & 2\mathcal{P}_\nu(\bar{\omega}) \end{pmatrix} \quad \text{evaluated at} \quad \bar{\omega} := \frac{\hat{\omega}_\ell + \hat{\omega}_r}{2}$$

is a Roe matrix [5]. To compute the eigenvalues numerically, the eigenvalue decomposition of the matrix $\mathcal{P}_\nu(\hat{\omega})$ must be determined. Under assumption (A) it is computationally cheap. In general, its eigenvalue decomposition causes a noteworthy computational overhead.

Figure 1 shows a computational result taken from [6], where the left initial water height is uniformly between three and four distributed. The Wiener-Haar basis is used for the intrusive formulation and Monte-Carlo is used as comparison, where the mean of pointwise entropies is shown on the right y -axis. We observe convergence to the mean of pointwise entropies (dashed in black) in the right part of the plot.

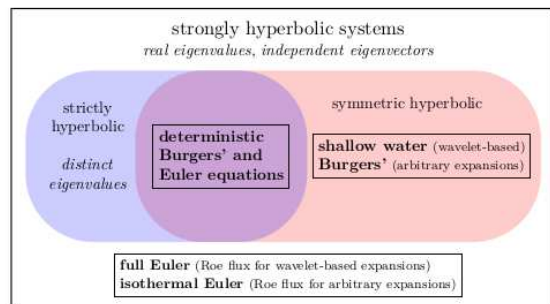

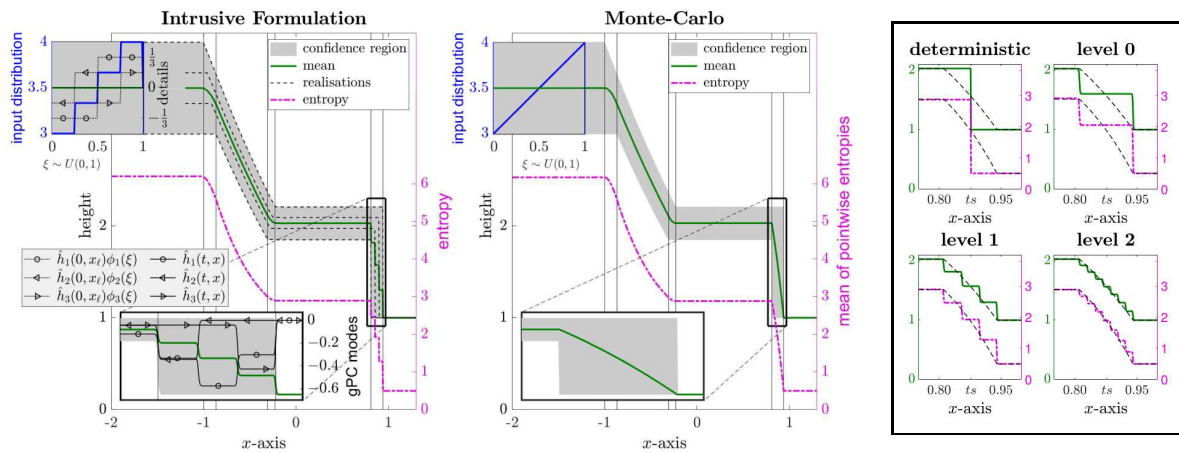

FIGURE 1. Dam break problem in $t = 0.5$ with uniformly distributed left initial value

REFERENCES

[1] B. Després, G. Poëtte, D. Lucor, *Uncertainty quantification for systems of conservation laws*, Journal of Computational Physics 228, 7, 2443–2467 (2009).
 [2] J. Giesselmann, F. Meyer, C. Rohde, *A posteriori error analysis for random scalar conservation laws using the stochastic Galerkin method*, IMA Journal of Numerical Analysis, 1–28 (2019).
 [3] S. Jin, R. Shu, *A study of hyperbolicity of kinetic stochastic Galerkin system for the isentropic Euler equations with uncertainty*, www.math.wisc.edu, preprint (2018).
 [4] P. Pettersson, G. Iaccarino, J. Nordström, *A stochastic Galerkin method for the Euler equations with Roe variable transformation*, Journal of Computational Physics, 257, A, 481–500 (2014).
 [5] S. Gerster, M. Herty, A. Sikstel, *Hyperbolic stochastic Galerkin formulation for the p-System*, RWTH Aachen, www.igpm.rwth-aachen.de, preprint 477 (2018).
 [6] S. Gerster, M. Herty, *Entropies and symmetrization of hyperbolic stochastic Galerkin formulations*, RWTH Aachen, www.igpm.rwth-aachen.de, preprint 488 (2019).

Convex Integraton Applied to the Multi-Dimensional Equations of Compressible Fluid Mechanics

CHRISTIAN KLINGENBERG

(joint work with Eduard Feireisl, Simon Markfelder)

In this lecture we would like to discuss the well-posedness of the initial value problem to the compressible Euler equations in two space dimensions. Using the standard admissibility criterion of entropy dissipation, we find that this problem allows for infinitely many weak solutions. We shall give several examples of this: for the isentropic Euler equations [1], for the full Euler equations [5], [3], [4] and magnetohydrodynamics [6]. Among these examples we give particular initial data, for which one can construct *standard* solutions with shocks and rarefactions, but in addition it is possible to prove the existence of infinitely many other weak

solutions. We present progress for the question if this is a phenomena generically true, meaning that it shows up only for particular initial data [2].

REFERENCES

- [1] Markfelder, S., Klingenberg, C. : *The Riemann problem for the multidimensional isentropic system of gas dynamics is ill-posed if it contains a shock*, Volume 227, Issue 3, Archive for Rational Mechanics and Analysis (2018)
- [2] E. Feireisl; C. Klingenberg; S. Markfelder, *On the density of wild initial data for the compressible Euler system*, arXiv:1812.11802 (2019)
- [3] Feireisl, E., Klingenberg, C., Kreml, O., Markfelder, S.: *On oscillatory solutions to the complete Euler equations*, arXiv:1710.10918 (2018)
- [4] Baba, Klingenberg, Kreml, Machla, Markfelder: *Non-uniqueness of admissible weak solution to the Riemann problem for the full Euler system in 2D*, arXiv:1805.11354 (2018)
- [5] Klingenberg, Markfelder, S.: *Non-uniqueness of energy-conservative solutions to the isentropic compressible two-dimensional Euler equations*, Journal of Hyperbolic Differential Equations, Vol. 15,4 (2018)
- [6] C. Klingenberg; S. Markfelder, *Non-uniqueness of entropy-conserving solutions to the ideal compressible MHD equations*, accepted in Proceedings of HYP2018, AIMS Journals, arXiv:1902.01446 (2019)

Recent Results Pushing Forward Theory of Well-posedness for Hyperbolic Systems of Conservation Laws in One Space Dimension

SAM G. KRUPA

(joint work with Alexis F. Vasseur)

For hyperbolic systems of conservation laws in one space dimension, the best theory of well-posedness is restricted to solutions with small total variation [1]. Looking to expand on this theory, we push in new directions. One key difficulty is that for many systems of conservation laws, only one nontrivial entropy exists. In 2017, in joint work with A. Vasseur [3], we proved uniqueness for the solutions to the scalar conservation laws which verify only a single entropy condition. Our result was the first result in this direction which worked directly on the conservation law. In particular, we proved:

Theorem 1 (Single Entropy Condition for Burgers).

Let $u \in L^\infty(\mathbb{R} \times [0, \infty))$ be a weak solution with initial data $u^0 \in L^\infty(\mathbb{R})$ to the scalar conservation law in one space dimension with flux $A \in C^2(\mathbb{R})$ strictly convex. Assume u satisfies the entropy inequality for at least one strictly convex entropy $\eta \in C^2(\mathbb{R})$. Further, assume u satisfies a strong trace property.

Then u is the unique solution to the conservation law verifying Oleñnik's condition E and with initial data u^0 .

Further, our method was based on the theory of shifts and a-contraction developed by Vasseur and his team (see [4] for a survey of the theory of shifts). These theories are general theories and apply also to the systems case, leading us to hope the framework we built for the scalar conservation laws will apply to systems. In this talk, I reviewed the current progress on using the theory of shifts and

a-contraction to push forward the theory of well-posedness for systems of conservation laws in one space dimension. In particular, I presented the following theorem concerning hyperbolic systems of conservation laws in one space dimension (from [2]):

Theorem 2 (L^2 Stability for the Riemann Problem for Systems). \bar{v} – classical Riemann solution (a fan) where any shocks are extremal.

u – rough solution with traces. Entropic for a strictly convex entropy. Can have shocks from any family.

Then,

$$(1) \quad \int_{-R}^R |u(x, t_0) - \Psi_{\bar{v}}(x, t_0)|^2 dx \leq C \int_{-R-rt_0}^{R+rt_0} |u^0(x) - \bar{v}(x, 0)|^2 dx,$$

for $R, t_0 > 0$. $r =$ speed of info.

$\Psi_{\bar{v}}$ is the shifted \bar{v} – we shift each shock.

Note that,

- For 2×2 systems, all shocks are extremal shocks.
- This theorem applies to the full Euler system.
- The theorem holds for a large class of systems.

REFERENCES

- [1] Alberto Bressan, Graziano Crasta, and Benedetto Piccoli. Well-posedness of the Cauchy problem for $n \times n$ systems of conservation laws. *Mem. Amer. Math. Soc.*, 146(694):viii+134, 2000.
- [2] Sam G. Krupa. Finite time stability for the Riemann problem with extremal shocks for a large class of hyperbolic systems. *arXiv e-prints*, page arXiv:1905.04347, May 2019.
- [3] Sam G. Krupa and Alexis F. Vasseur. On uniqueness of solutions to conservation laws verifying a single entropy condition. *J. Hyperbolic Differ. Equ.*, 16(1):157–191, 2019.
- [4] Denis Serre and Alexis F. Vasseur. About the relative entropy method for hyperbolic systems of conservation laws. In *A panorama of mathematics: pure and applied*, volume 658 of *Contemp. Math.*, pages 237–248. Amer. Math. Soc., Providence, RI, 2016.

Well-Balanced Schemes via Flux Globalization

ALEXANDER KURGANOV

(joint work with Yuanzhen Cheng, Alina Chertock, Shumo Cui, Michael Herty, Yongle Liu, Şeyma Nur Özcan, Eitan Tadmor, Tong Wu, Vladimir Zeitlin)

We have developed a new method of constructing well-balanced schemes for hyperbolic systems of balance laws. Our approach is based on incorporating the source terms into the fluxes. This leads to flux globalization as the rewritten system becomes a system of conservation—not balance—laws, but with a global flux, which makes it quite complicated to design an upwind scheme. It is not difficult, however, to construct Riemann-problem-solver-free central-upwind schemes for the systems with global fluxes.

Our new approach has been demonstrated on several shallow water models. We first applied it to the Saint-Venant system of shallow water equation with Manning friction term and designed a moving-water equilibria preserving central-upwind scheme; see [1]. The second application is to the compressible Euler equations with gravitation; see [2]. Finally, we apply the proposed approach to the thermal rotating shallow water equations; see [3].

REFERENCES

- [1] Y. Cheng, A. Chertock, M. Herty, A. Kurganov and T. Wu, *A new approach for designing moving-water equilibria preserving schemes for the shallow water equations*, Journal of Scientific Computing **80** (2019), 538–554.
- [2] A. Chertock, S. Cui, A. Kurganov, Ş. N. Özcan and E. Tadmor, *Well-balanced schemes for the Euler equations with gravitation: conservative formulation using global fluxes*, Journal of Computational Physics **358** (2018), 36–52.
- [3] A. Kurganov, Y. Liu and V. Zeitlin, *A well-balanced central-upwind scheme for the thermal rotating shallow water equations*, submitted (preprint is available at <http://dauns01.math.tulane.edu/~kurganov/Kurganov-Liu-Zeitlin.pdf>).

Instabilities and Non-Uniqueness in Ideal Fluids

LÁSZLÓ SZÉKELYHIDI JR.

We discuss some examples of ‘wild’ weak solutions, and their significance, in various models. In the first part we address the question of optimality of the integrability condition of DiPerna-Lions theory for uniqueness and renormalization of weak solutions of the transport equations. We present results obtained together with S. Modena and G. Sattig (Leipzig) on the existence of multiple and non-renormalized solutions of the transport equation in $d \geq 2$ space dimensions with divergence-free vectorfields in Sobolev spaces $u \in W^{1,p}$ and density $\rho \in L^q$, with $\frac{1}{p} + \frac{1}{q} > 1 + \frac{1}{d}$. Recalling that the DiPerna-Lions theory requires $\frac{1}{p} + \frac{1}{q} \leq 1$, these examples show in particular that the integrability condition of DiPerna-Lions is optimal in sufficiently high dimension. In the talk we emphasize the important role of dimensional analysis and the applicability of notions of sub- and super-criticality in this context.

In the second part we discuss the existence and multiplicity of weak solutions arising in classical fluid interface problems related to instabilities. We address two models: the unstable Muskat problem and the vortex sheet problem. These are related to the classical Rayleigh-Taylor and Kelvin-Helmholtz instabilities respectively. The sharp interface problem in both models is strongly ill-posed. We show that with a suitable ‘mixing’ ansatz weak solutions can be constructed via a relaxation technique and convex integration. These are not solutions of the sharp interface problem, but rather are weak solutions of the underlying ‘Eulerian’ model: the incompressible porous medium equation, and the 2D incompressible Euler equations, respectively. The emphasis here is on the connection between the presence of instabilities on the one hand and the loss of compactness in the

solution spaces and existence of multiple weak solutions on the other hand. This part is based on joint work with C. Förster (Leipzig) and F. Mengual (Madrid).

Qualitative Studies on Radiation Hydrodynamics Equations

YACHUN LI

(joint work with Hao Li, Shuai Xi, Shengguo Zhu)

As we know, the effects of heat radiation increase with the growth of temperature. In particular, for the case of thermal equilibrium, radiation energy density is in proportion to the fourth power of temperature. Radiation sometimes contributes largely to energy density, momentum density and pressure, for instance, in astrophysics and inertial confinement fusion. Radiation transfer is usually the most effective mechanism which affects the energy exchange in fluids, so it is necessary to take effects of the radiation field into consideration in the hydrodynamic equations. The radiation hydrodynamics (RHD) equations result from the balances of particles, momentum and energy. To describe the radiation field and its interaction with matter at any time t , we need $2d$ variables to specify the state of a photon in phase space, namely, d position variables and d velocity (or momentum) variables. Usually, we can denote by x the d position variables, and replace the d momentum variables equivalently with frequency v and the travel direction Ω of the photon. In the radiation transport, we usually use the specific radiation intensity $I = I(t, x, v, \Omega)$ instead of the distribution function $f(t, x, v, \Omega)$. The specific radiation intensity is defined as $I = chvf(x, t, v, \Omega)$ with the Planck constant h and the light speed c . The physical interpretation of I is contained in the relationship

$$dE_1 = I(t, x, v, \Omega) \cos \Theta d\sigma dv d\Omega dt,$$

where dE_1 is the amount of the radiation energy in dv centered at v , traveling in a direction Ω confined to a solid angle element $d\Omega$, which crosses, in a time element dt , an area $d\sigma$ oriented such that Θ is the angle which the direction Ω makes with the normal to $d\sigma$ ($\cos \Theta = \Omega \cdot \mathbf{n}$, here \mathbf{n} is the outward unit normal vector of $d\sigma$).

Regarding the three basic interactions between photons and matter, namely, absorption, scattering and emission, we have transport equation in the general form

$$\frac{1}{c} \partial_t I + \Omega \cdot \nabla I = A_r,$$

with the collision term

$$A_r = \sigma_e - \sigma_a I + \int_0^\infty \int_{S^{d-1}} \left(\frac{v}{v'} \sigma_s(v' \rightarrow v, \Omega' \cdot \Omega) I' - \sigma_s(v \rightarrow v', \Omega \cdot \Omega') I \right) d\Omega' dv',$$

where $I = I(t, x, v, \Omega)$, $I' = I(t, x, v', \Omega')$, S^{d-1} is the unit sphere in \mathbb{R}^d , $\sigma_e = \sigma_e(t, x, v, \rho, \theta)$ is the rate of energy emission due to spontaneous process, and $\sigma_a = \sigma_a(t, x, v, \rho, \theta)$ denotes the absorption coefficient that may also depend on the mass density ρ and the temperature θ of the matter. $\sigma_s(v' \rightarrow v, \Omega' \cdot \Omega) \equiv \sigma_s(v' \rightarrow v, \Omega' \cdot \Omega, \rho, \theta)$ is the differential scattering coefficient that may depend on ρ and

θ such that the probability of a photon being scattered from v' to v contained in dv , from Ω' to Ω contained in $d\Omega$, and traveling a distance ds is given by $\sigma_s(v' \rightarrow v, \Omega' \cdot \Omega)dv d\Omega ds$. We assume that σ_e and σ_a are independent of Ω and σ_s depends only on $\Omega \cdot \Omega'$, which means that there exists no inherent preferred direction in the matter.

We introduce three physical quantities to describe the impact of radiation on dynamical properties of the fluid:

$$\begin{cases} E_r = \frac{1}{c} \int_0^\infty \int_{S^{d-1}} I(t, x, v, \Omega) d\Omega dv, \\ F_r = \int_0^\infty \int_{S^{d-1}} I(t, x, v, \Omega) \Omega d\Omega dv, \\ P_r = \frac{1}{c} \int_0^\infty \int_{S^{d-1}} I(t, x, v, \Omega) \Omega \otimes \Omega d\Omega dv, \end{cases}$$

which are called the radiation energy density, the radiation flux, and the radiation pressure tensor, respectively. After taking radiation effect into consideration for viscous fluids we have the following radiation hydrodynamics equations (*Navier-Stokes-Boltzmann* equations) in the d -dimensional ($d \geq 2$) space:

$$(1) \quad \begin{cases} \frac{1}{c} \partial_t I + \Omega \cdot \nabla I = A_r, \\ \partial_t \rho + \nabla \cdot (\rho u) = 0, \\ \partial_t (\rho u + \frac{1}{c^2} F_r) + \nabla \cdot (\rho u \otimes u + P_r) + \nabla p_m = \nabla \cdot \mathbb{T}, \\ \partial_t (E_m + E_r) + \nabla \cdot ((E_m + p_m)u + F_r) = \nabla \cdot (u\mathbb{T}) + \nabla \cdot (k(\theta)\nabla\theta), \end{cases}$$

where $x \in \mathbb{R}^d$; $u = (u_1, u_2, \dots, u_d) \in \mathbb{R}^d$ is the velocity of fluid; ρ is the density of the fluid; $E_m = \frac{1}{2}\rho|u|^2 + \rho e$ is the material energy density of the fluid with e the internal energy; $k(\theta) \geq 0$ is the heat conductivity; p_m is the material pressure; \mathbb{T} is the viscous stress tensor. The corresponding radiation system for inviscid fluids is called *Euler-Boltzmann*.

It is worth mentioning that one of the motivation that we study the radiation system is that the Navier-Stokes equations can be regarded as the non-radiation limit of the radiation system to some extent; for the rigorous justification of this type of limit, we refer to [5]. We also remark that there do exist some phenomena different from the non-radiation hydrodynamics equations caused by the coupling of radiation and hydrodynamics [1, 2, 10].

In general, studying the above-mentioned radiation hydrodynamics equations is challenging because of its complexity and mathematical difficulty, and there are few results. The known results about local well-posedness and blow-up of C^1 solutions [6, 7] and global weak solutions and its large time behavior for the 1-D case [3, 4] are all for non-vacuum case. Recently, we studied systematically on

the well-posedness of solutions, formation of singularities, as well as the blow-up criteria for multi-D compressible RHD equations with vacuum as follows.

- We present some sufficient conditions on the blow-up of smooth solutions to the Cauchy problem of Navier-Stokes-Boltzmann equations with vacuum and obtain the invariance of the support of density, based on which we proved the finite time blow-up of classical solutions when the initial mass density is compactly supported, which implies that the radiation effect is not strong enough to prevent the formation of singularities caused by vacuum [10].
- We established the existence and uniqueness of local regular solutions to the Cauchy problem of isentropic Euler-Boltzmann equations with vacuum and also showed that the regular solutions will blow up for some special initial density with local vacuum [12].
- We obtained the existence of unique local strong solutions with vacuum to the Cauchy problem and initial boundary value problem of Navier-Stokes-Boltzmann equations and established some corresponding blow-up criteria [8, 9, 11, 13].

Acknowledgments. Our research was supported in part by National Natural Science Foundation of China under grants 11231006, 11571232 and 11831011.

REFERENCES

- [1] C. Buet and B. Després, *Asymptotic analysis of fluid models for the coupling of radiation hydrodynamics*, J. Quant. Spectroscopy Rad. Transf **85** (2004) 385–418.
- [2] B. Ducomet, E. Feireisl and Š. Nečasová, *On a model in radiation hydrodynamics*, Ann. Inst. H. Poincaré. (C) Non Line. Anal. **6** (2011) 797–812.
- [3] B. Ducomet and Š. Nečasová, *Global weak solutions to the one-dimensional compressible Navier-Stokes equations with radiation*, Commun. Math. Anal **8** (2010) 23–65.
- [4] B. Ducomet and Š. Nečasová, *Large time behavior of the motion of a viscous heat-conducting one-dimensional gas coupled to radiation*, Annali di Matematica Pura ed Applicata **8** (2010) 219–260.
- [5] B. Ducomet and Š. Nečasová, *Diffusion limits in a model of radiative flow*, Ann. Univ. Ferrara Sez. VII Sci. Mat. **61**(1) (2015) 17–59.
- [6] P. Jiang and D. Wang, *Formation of singularities of solutions to the three-dimensional Euler-Boltzmann equations in radiation hydrodynamics*, Nonlinearity **23** (2010) 809–821.
- [7] S. Jiang and X. Zhong, *Local existence and finite-time blow-up in multidimensional radiation hydrodynamics*, J. Math. Fluid. Mech. **9** (2007) 543–64.
- [8] H. Li and Y. Li, *Local Existence and Serrin-type Blow-Up Criterion for strong solutions to the Cauchy problem of Radiation Hydrodynamic equations*, submitted, 2019.
- [9] Y. Li and S. Xi, *Blow-up criteria for three-dimensional compressible radiation hydrodynamics equations with vacuum*, J. Math. Anal. Appl. **458**(2)(2018) 1166–1192.
- [10] Y. Li and S. Zhu, *Formation of singularities in solutions to the compressible radiation hydrodynamics equations with vacuum*, J. Differential Equations **256** (2014), 3943–3980.
- [11] Y. Li and S. Zhu, *Existence results for compressible radiation hydrodynamics equations with vacuum*, Commun. Pure Appl. Anal. **14** (3) (2015), 1023–1052.
- [12] Y. Li and S. Zhu, *On regular solutions of the 3-D compressible isentropic Euler-Boltzmann equations with vacuum*, Discrete Contin. Dyn. Syst. **35** (7) (2015), 3059–3088.
- [13] Y. Li and S. Zhu, *Existence results and blow-up criterion of compressible radiation hydrodynamic equations*, J. Dynam. Differential Equations, **29**(2) (2017) 549–595.

On Well-Posedness of Weak Solutions

TAI-PING LIU

This is to comment on the well-posedness of weak solutions for time-dependent partial differential equations. There is the Hadamard well-posedness requirements of existence, uniqueness and continuous dependence of the solution on the initial data. The well-posedness of classical solutions follows basically from the mean value theorem, as the smoothness of the solutions allows for the straightforward application of calculus. For linear equations, the well-posedness of weak solutions is shown by the a priori estimates by the principle of linear superposition. There is usually a problem with the well-posedness of weak solutions for nonlinear equations. This is due to the usual compactness argument in constructing the weak solutions which does not yield sufficient structure to the solutions. In fact, there is a striking non-uniqueness for incompressible Euler equations, [1], and even for compressible Euler equations, [2]. An important exception is the well-posedness theory for system of hyperbolic conservation laws. The existence is done by James Glimm, [3]. The Glimm scheme uses the solution of the Riemann problem as building blocks and is a random choice method. Subsequently, efforts were put in to make the Glimm solution algorithm more definite, [4], [5], [6]. This allows for the homotopy approach, [7] and the functional approach, [8] to work and the Glimm process is shown to be robust and a solution depends on its initial data continuously in $L_1(x)$. Note, however, the solutions obtained by theory of compensated compactness have not been shown to depend on the initial data continuously, for the general reason mentioned above. The classical solutions for viscous conservation laws have been constructed and shown to depend on the initial data continuously, [10], [11], [12], [13]. Weak solutions have also been constructed, and as expected, not known to depend on the initial data continuously, [14], [15], [16]. With Shih-Hsien Yu, we establish a well-posedness theory for weak solutions for the most basic system of viscous conservation laws, the isentropic Navier-Stokes equations in gas dynamics in the Lagrangian coordinates

$$\begin{cases} v_t - u_x = 0, \\ u_t + p(v)_x = \left(\kappa \frac{u_x}{v}\right)_x. \end{cases}$$

Our approach is to derive integral equations for the solutions using the Green's function for the linearized equations as well as the fundamental solution for a heat equation, whose heat conductivity coefficient is of bounded variation. The construction of the Green's function is explicit and generalizes earlier work [17]. The fundamental solution is constructed using stochastic formulation. These explicit constructions are essential for formulating the integrals for the solution. Assuming that the initial value is of small total variation and a $L_1(x)$ perturbation of a constant state, the solution is constructed and shown to depend on the initial value continuously in $L_1(x)$. One notes that physical systems of the form of viscous conservation laws are hyperbolic-parabolic and initial singularity propagates into later time. Our method is general and should be applicable to more general systems.

REFERENCES

- [1] Scheffer, V. An inviscid flow with compact support in space-time. *J. Geom. Anal.* 3(4), 343-401 (1993)
- [2] De Lellis C, Székelyhidi L. On admissibility criteria for weak solutions of the Euler equations. *Arch. Ration. Mech. Anal.* 195 (2010), no. 1, 225-260
- [3] Glimm, James. Solutions in the large for nonlinear hyperbolic systems of equations. *Comm. Pure Appl. Math.* 18 (1965), 697-715
- [4] Glimm, James; Lax, Peter D. Decay of solutions of systems of nonlinear hyperbolic conservation laws. *Memoirs of the American Mathematical Society*, No. 101 American Mathematical Society, Providence, R.I. 1970 xvii+112 pp
- [5] Dafermos, C. M. Polygonal approximations of solutions of the initial value problem for a conservation law. *J. Math. Anal. Appl.* 38 (1972), 33-41
- [6] Liu, T.-P. The deterministic version of the Glimm scheme. *Comm. Math. Phys.* 57 (1977), no. 2, 135-148
- [7] Bressan, A. Contractive metrics for nonlinear hyperbolic systems, *Indiana Univ. Math. J.* 37 (1988), 409-421
- [8] Liu, T.-P.; Yang, T. A new entropy functional for a scalar conservation law. *Comm. Pure Appl. Math.* 52 (1999), no. 11, 1427-1442
- [9] Bianchini, S.; Bressan, A. Vanishing viscosity solutions of nonlinear hyperbolic systems. *Ann. of Math.* 161, (2005), 223-342
- [10] Kanel, Ya . I., On a model system of equations for one-dimensional gas motion, *Diff. Eq.* (in Russian) 4 (1968) 721-734
- [11] Itaya , N., On the Cauchy problem for the system of fundamental equations describing the movement of compressible viscous fluid, *Kodai Math. Sem . Rep.*, 23 (1971) 60-120
- [12] Matsumura, A., and Nishida, T., The initial value problem for the equations of motion of viscous and heat conductive gases. *J. Math. Kyoto Univ.* 20-1 (1980) 67-104
- [13] Shizuta, Y. and Kawashima, S.. Systems of equations of hyperbolic-parabolic type with applications to the discrete Boltzmann equation. *Hokkaido Math. J.* 14 (1985), 249-275
- [14] Hoff, D., Global solutions of the Navier-Stokes equations for multidimensional compressible flow with discontinuous initial data. *JDE*, 120 (1995) 215-254
- [15] Lions, P.L., *Mathematical Topics in Fluid Mechanics: Volume 2: Compressible Models.* Oxford Lecture Series in Mathematics and its Applications, 10. (1996)
- [16] Feireisl, E. *Dynamics of Viscous Compressible Fluids.* Oxford Lecture Series in Mathematics and its Applications, 26. (2004)
- [17] Zeng, Y., L1 asymptotic behavior of compressible, isentropic, viscous 1-D flow, *Comm. Pure Appl. Math.* 47 (1994), 1053-1082

The Role of Young Measures in Convergence Analysis of Compressible Flows

MÁRIA LUKÁČOVÁ-MEDVIĐOVÁ

(joint work with Eduard Feireisl, Hana Mizerová, Bangwei She)

The rigorous convergence analysis of finite volume or finite element methods for multidimensional compressible flows has been open for decades. Just recently we were able to show rigorously their convergence by using the concept of *dissipative measure-valued solutions*. We have derived suitable stability and consistency estimates that imply that the Young measure generated by numerical solutions represents a dissipative measure-valued solution of the limit system. We use either the conditional regularity result and/or the dissipative measure-valued-strong

uniqueness result to conclude the strong convergence of finite volume solutions to the strong solution of the limiting system [1, 2, 3, 4].

It is well known that the Euler equations give rise to essentially ill-posed problems allowing infinitely many weak entropy solutions. In such a case the convergence of the numerical schemes becomes of fundamental importance. In our recent work [5] we have generalized the concept of \mathcal{K} (Komlos)-convergence of Young measures to the sequences of numerical solutions. This allows us to show that there exists a subsequence of our numerical solutions such that the Cesaro averages (partial sums) of the corresponding Dirac measures converge strongly to the dissipative measure-valued solutions in $L^1((0, T) \times \Omega)$ and with respect to the Wasserstein distance W^1 . In other words, we have obtained new results on pointwise convergence of Cesaro averages of numerical solutions to a generalized (dissipative) solution of the Euler equations. Moreover, we have also showed how the presence of oscillations in numerical solutions may provide an evidence that the continuous problem exhibits singularities.

REFERENCES

- [1] Feireisl, E., Lukáčová-Medvid'ová, M.: *Convergence of a mixed finite element–finite volume scheme for the isentropic Navier–Stokes system via the dissipative measure–valued solutions*, Found. Comput. Math. **18**(3) (2018):703–730.
- [2] Feireisl, E., Lukáčová-Medvid'ová, M., Mizerová, H.: *Convergence of finite volume schemes for the Euler equations via dissipative measure–valued solutions*, submitted, 2018.
- [3] Feireisl, E., Lukáčová-Medvid'ová, M., Mizerová, H.: *A finite volume scheme for the Euler system inspired by the two velocities approach*, submitted, 2018.
- [4] Feireisl, E., Lukáčová-Medvid'ová, M., Mizerová, H., She, B.: *Convergence of a finite volume scheme for the compressible Navier–Stokes system*, accepted to ESAIM Math. Model. Numer. Anal. 2019.
- [5] Feireisl, E., Lukáčová-Medvid'ová, M., Mizerová, H.: *K–convergence as a new tool in numerical analysis*, submitted, 2019.

A Microscopic Model on a Traffic Network

FRANCESCA MARCELLINI

(joint work with Rinaldo M. Colombo, Helge Holden)

We introduce a formalism to deal with the microscopic modeling of vehicular traffic on a road network. From the analytic point of view, this amounts to define ordinary differential equations on a graph. To this aim, we extend the standard first order *Follow–the–Leader* (FtL) model, see [2], given by a system of n ordinary differential equations describing the positions of n drivers on a general network. More precisely, we assume to have a network composed by a collection of m real intervals, where roads are of three types: *Entry Roads*, which are copies of the (open) half–line $]-\infty, 0[$; *Middle Roads*, which are bounded intervals of the type $[0, L_j[$, where $L_j > 0$ is the road length; *Exit Roads*, which are copies of the half–line $[0, +\infty[$. In the following, we consider n drivers indexed by α , running between 1 and n . We denote by $r_\alpha(t)$ the index of the road along which the α -th driver is

traveling at time t and by \mathcal{R}_α the route (a sequence of adjacent roads) followed by driver α . We have the following assumptions in the construction below:

(NoLoop): No route can contain twice the same road.

(NoDeadEnd): The last road in each route is an Exit Road.

We are now ready to extend the standard first order *Follow-the-Leader* (FtL) model to the case of a network segment:

$$\dot{x}_\alpha = \begin{cases} V_{r_\alpha(t)} & \text{if } \begin{cases} \alpha \text{ is not at the end of the road;} \\ \text{no one is on the same road in front of } \alpha. \end{cases} \\ v_{r_\alpha(t)}\left(\frac{\ell}{p-x_\alpha}\right) & \text{if } \begin{cases} \text{someone is on the same road in front of } \alpha; \\ p = \text{the nearest to } \alpha \text{ in front of } \alpha, \end{cases} \end{cases}$$

where ℓ is the length of each vehicle and the speed v_j satisfies the condition:

(SpeedLaw): $v \in \mathcal{C}^{0,1}(\mathbb{R}^+; [0, V_{\max}])$ is a (weakly) decreasing function such that $v(\rho) = 0$ for all $\rho \geq 1$.

The constant V_{\max} is an upper bound for all vehicles' speed. Indeed, if no such drivers exist, α drives at the maximal speed $V_{r_\alpha(t)}$ possible along the road $r_\alpha(t)$. On the contrary, if someone is on the same road in front of α , then the speed $\dot{x}_\alpha(t)$ of the α -th driver is adjusted to the distance between α and the driver at p , who is the one immediately preceding α , as usual in a *Follow the Leader* model.

Consider now a crossroad with one road entering it and any number of roads exiting from it. Assume now that at time t driver α is near to the crossroad, at the end of the road. Driver α chooses his/her speed $\dot{x}_\alpha(t)$ taking into consideration only those drivers preceding him/her along the road $r_\alpha(t)$ or present in the next road he/she is going to take. We then set

$$\dot{x}_\alpha = \begin{cases} V_{r_\alpha(t)} & \text{if } \begin{cases} \alpha \text{ is at the end of the road;} \\ \text{no one is on the same road in front of } \alpha; \\ \text{no one is on the road where } \alpha \text{ is going.} \end{cases} \\ v_{r_\alpha(t)}\left(\frac{\ell}{p+L_{r_\alpha(t)}-x_\alpha}\right) & \text{if } \begin{cases} \alpha \text{ is at the end of the road;} \\ \text{no one is on the same road in front of } \alpha; \\ \text{someone is on the road where } \alpha \text{ is going;} \\ p = \text{the nearest to } \alpha \text{ where } \alpha \text{ is going.} \end{cases} \end{cases}$$

Indeed, when the road where α is going is empty, no one is preceding the α -th driver along his/her route and the α -th driver proceeds full speed. On the contrary, if someone is on the road where α is going, then the driver immediately preceding α is at p . The resulting speed $\dot{x}_\alpha(t)$ of the α -th driver is then chosen according to the usual *Follow the Leader* rule, with $p + L_{r_\alpha(t)} - x_\alpha(t)$ being the physical distance between the α -th driver and his/her predecessor.

Consider now a junction with several roads entering a single road. We assume that the roads' indexing respects the roads' priorities, in the sense that if the roads j and j' enter the same junction and $j < j'$, then the drivers on the road j have priority over those on road j' .

First we deal with the case of a driver coming from the road that has the priority over all the other incoming road, which is similar to the previous one. We then set

$$\dot{x}_\alpha = \begin{cases} V_{r_\alpha(t)} & \text{if } \begin{cases} \alpha \text{ is at the end of the road;} \\ \alpha\text{'s road has the priority;} \\ \text{no one is on the same road in front of } \alpha; \\ \text{no one is on the road where } \alpha \text{ is going.} \end{cases} \\ v_{r_\alpha(t)} \left(\frac{\ell}{p + L_{r_\alpha(t)} - x_\alpha} \right) & \text{if } \begin{cases} \alpha \text{ is at the end of the road;} \\ \alpha\text{'s road has the priority;} \\ \text{no one is on the same road in front of } \alpha; \\ \text{someone is on the road where } \alpha \text{ is going;} \\ p = \text{the nearest to } \alpha \text{ where } \alpha \text{ is going.} \end{cases} \end{cases}$$

Let now the α -th driver approach the crossroad along the road $r_\alpha(t)$ which yields priority to other roads. Assume that at the end of road j , entering the junction, there is no one that has the priority over the road $r_\alpha(t)$, and there is no one in the road that α is entering. Then, α drives at full speed $V_{r_\alpha(t)}$, that is

$$\dot{x}_\alpha = V_{r_\alpha(t)} \quad \text{if } \begin{cases} \alpha \text{ is at the end of the road;} \\ \alpha\text{'s road does not have the priority;} \\ \text{no one is on the same road in front of } \alpha; \\ \text{no one is on the road where } \alpha \text{ is going;} \\ \text{no one is at the end of roads having priority over } \alpha. \end{cases}$$

As soon as an other driver, say α' , is present near to the end of road $j' = r_{\alpha'}(t)$ entering the crossroad and having priority over the $r_\alpha(t)$ road, the α -th driver has to give precedence to α' and stops. That is,

$$\dot{x}_\alpha = 0 \quad \text{if } \begin{cases} \alpha \text{ is at the end of the road;} \\ \alpha\text{'s road does not have the priority;} \\ \text{no one is on the same road in front of } \alpha; \\ \text{someone is at the end of roads having priority over } \alpha. \end{cases}$$

Finally, no one is present on the road having priority over the $r_\alpha(t)$ road where the α -th driver is moving, but other vehicles are present on the road where α is going. Then, the α -th driver adapts his/her speed to the vehicle he/she has in front, and we have:

$$\dot{x}_\alpha = v_{r_\alpha(t)} \left(\frac{\ell}{p + L_{r_\alpha(t)} - x_\alpha} \right) \quad \text{if } \begin{cases} \alpha \text{ is at the end of the road;} \\ \alpha\text{'s road does not have the priority;} \\ \text{no one is on the same road in front of } \alpha; \\ \text{no one is at the end of roads having priority;} \\ \text{someone is on the road where } \alpha \text{ is going;} \\ p = \text{the nearest to } \alpha \text{ where } \alpha \text{ is going.} \end{cases}$$

Summarizing, the above systems define a system of n ordinary differential equations, which we write

$$(1) \quad \dot{x}_\alpha = \mathcal{V}_\alpha(t, x)$$

for short. The definitions above ensure that $\mathcal{V}_\alpha(t, x) \in [0, V_{\max}]$ for all $i = 1, \dots, n$, $t \in [0, T]$ and $x \in \mathbb{R}^n$.

We now introduce a condition that states the absence of collisions among drivers:

(NoCollision): $\forall \alpha', \alpha'' \in \{1, \dots, n\}$, if $r_{\alpha'} = r_{\alpha''}$, then $|x_{\alpha'} - x_{\alpha''}| \geq \ell$.

The following main result holds (see [1] for the proof):

Theorem 1. *Consider a network of m (with $m \in \mathbb{N} \setminus \{0\}$) interconnected roads containing at least one Entry Road and one Exit Road. For $j = 1, \dots, m$, on road j a speed law v_j satisfying **(SpeedLaw)** is given. Assign to n (with $n \in \mathbb{N} \setminus \{0\}$) drivers routes $\mathcal{R}_1, \dots, \mathcal{R}_n$ satisfying the **(NoLoop)** and **(NoDeadEnd)** conditions. Each driver α is assigned an initial position x_α in the first road of the α 's route \mathcal{R}_α and these initial positions satisfy condition **(NoCollision)**.*

*Then, the differential equation (1) admits a unique solution on the time interval $[0, +\infty[$. Moreover, at any positive t , the positions $x_\alpha(t)$ of the drivers at time t along roads $r_\alpha(t)$, keep satisfying condition **(NoCollision)**.*

REFERENCES

- [1] R.M. Colombo, H. Holden, F. Marcellini, *On the Microscopic Modeling of Vehicular Traffic on General Networks*, Preprint (2019).
- [2] D.C. Gazis, R. Herman and R.W. Rothery, *Nonlinear Follow-the-Leader Models of Traffic Flow*, *Operations Res.* **9** (1961), 545–567.

A stabilized DG cut Cell Method for discretizing the Linear Transport Equation

SANDRA MAY

(joint work with Christian Engwer, Andreas Nüßing, Florian Streitbürger)

Abstract. The generation of body-fitted, unstructured meshes can be very time-consuming for domains that involve objects with complex geometries. Therefore, unfitted or embedded boundary methods have become very popular in recent years. In our approach, we simply cut the object out of a standard (Cartesian) background mesh, resulting in so called *cut cells* along the boundary of the embedded object. Cut cells have various shapes and can become arbitrarily small.

When solving time-dependent, hyperbolic conservation laws, a big issue is the *small cell problem*: standard explicit time stepping schemes are not stable on the arbitrarily small cut cells if the time step is chosen according to the background mesh. Therefore, one needs special schemes. In the context of finite volume schemes, there already exist several approaches for solving this issue. In the context of discontinuous Galerkin (DG) schemes however we do not know of any approach that does not rely on merging small cut cells with their bigger neighbors.

We suggest new stabilization terms to overcome the small cell problem for the linear advection equation in two dimensions for DG schemes with piecewise linear polynomials. Our stabilization is designed to only let a certain fraction of the

inflow of a small cut cell stay in that small cut cell and to transport the remaining portion directly into the cut cell’s outflow neighbors. This way we reconstruct the proper domain of dependence of the small cut cell’s outflow neighbors. In that sense our stabilization uses similar ideas as the h -box method [1] but its implementation reminds of the ghost penalty method [2], even though significant changes were necessary.

The proposed stabilization allows for using explicit time stepping, even on cut cells. In one dimension, we can show monotonicity of the proposed scheme for piecewise constant polynomials and total variation diminishing in the means stability for piecewise linear polynomials. Numerical results in two dimensions confirm the stability considerations. In terms of accuracy, we observe for smooth initial data and piecewise linear polynomials second-order convergence for the error in the L^1 norm and slightly reduced rates for the error in the L^∞ norm [3].

Piecewise constant polynomials in one dimension. In the following we will focus on the case of piecewise constant polynomials in one dimension to explain the main idea behind our stabilization.

We consider the linear advection equation

$$(1) \quad u_t(x, t) + \beta u_x(x, t) = 0 \text{ in } (0, 1) \times (0, T), \quad \beta > 0 \text{ constant,}$$

with initial data $u(x, 0) = u_0(x)$ and periodic boundary conditions. To mimic the situation of a cut cell, we consider the model problem shown in figure 1.

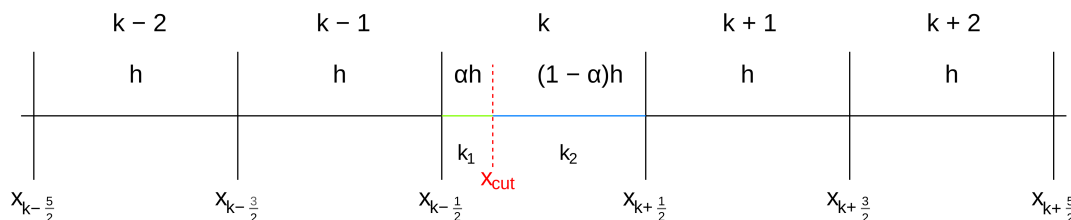

FIGURE 1. Model problem: Equidistant mesh with one cell, cell k , split into two cells of lengths αh and $(1 - \alpha)h$ with $\alpha \in (0, \frac{1}{2}]$.

We use $V_h = P^0$, i.e., piecewise constant functions, and introduce jumps

$$[[v_h]]_{j+\frac{1}{2}} = v_h(x_{j+\frac{1}{2}}^-) - v_h(x_{j+\frac{1}{2}}^+), \quad x_{j+\frac{1}{2}}^\pm = \lim_{\varepsilon \rightarrow 0} x_{j+\frac{1}{2}} \pm \varepsilon.$$

The standard DG discretization using upwind flux, which coincides with the finite volume upwind scheme in space, is then given by: Find $u_h \in V_h$ such that

$$(2) \quad \langle d_t u_h(t), w_h \rangle + a_h^{\text{upw}}(u_h(t), w_h) = 0, \quad \forall w_h \in V_h,$$

with

$$a_h^{\text{upw}}(u_h, w_h) = \sum_{j=1}^N \beta u_h(x_{j+\frac{1}{2}}^-) [[w_h]]_{j+\frac{1}{2}}.$$

Using method of lines we derive a system of ordinary differential equations of the form $\underline{y}_t = A \underline{y}$ with a suitable matrix A . Figure 2 shows the eigenvalue distribution

of $\Delta t A$ where $\Delta t = \lambda h$ for $\alpha = 0.001$, $\beta = 1$, $\lambda = 0.5$, and $h = 0.05$. For the unstabilized scheme, we observe that all eigenvalues lie in the stability region of explicit Euler except for one outlier, corresponding to the degree of freedom on the small cut cell k_1 . In other words: if we choose Δt proportional to h but without considering α , explicit time stepping is unstable.

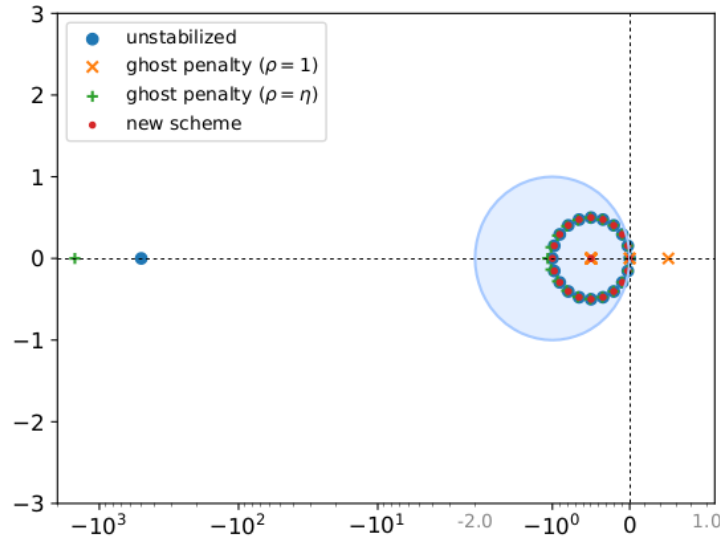

FIGURE 2. Distribution of eigenvalues for the three spatial discretizations described in (2), (3), and (4).

Next, we consider a straight-forward adaptation of the ghost penalty method [2] that is used for stabilizing elliptic problems. In this case we would solve: Find $u_h \in V_h$ such that $\forall w_h \in V_h$

$$(3) \quad \langle d_t u_h(t), w_h \rangle + a_h^{\text{upw}}(u_h(t), w_h) + J_h^{\text{ghost}}(u_h, w_h) = 0,$$

with

$$J_h^{\text{ghost}}(u_h, w_h) = \rho_1 \llbracket u_h \rrbracket_{k-\frac{1}{2}} \llbracket w_h \rrbracket_{k-\frac{1}{2}} + \rho_2 \llbracket u_h \rrbracket_{\text{cut}} \llbracket w_h \rrbracket_{\text{cut}}.$$

For simplicity we first choose $\rho_1 = \rho_2 = 1$. As can be seen in figure 2, this stabilization does *not* help to restore stability of explicit time stepping schemes. Next, we try $\rho_1 = \rho_2 = \eta$ with $\eta = 1 - \frac{\alpha}{2\lambda}$ as η is the factor that the new stabilization uses. Again, this does not help.

Finally, the stabilized scheme that we suggest is for this specific test case given by: Find $u_h \in V_h$ such that $\forall w_h \in V_h$

$$(4) \quad \langle d_t u_h(t), w_h \rangle + a_h^{\text{upw}}(u_h(t), w_h) + J_h^{\text{hyp}}(u_h, w_h) = 0,$$

with

$$J_h^{\text{hyp}}(u_h, w_h) = \eta \llbracket u_h \rrbracket_{k-\frac{1}{2}} \llbracket w_h \rrbracket_{\text{cut}}.$$

Figure 2 confirms that the outlier eigenvalue has been moved back to the stability region of explicit Euler. In addition, one can show that the resulting scheme is monotone [3]. We note that for the ghost penalty stabilization J_h^{ghost} , it is not

possible to choose ρ_1 and ρ_2 in such a way that the combination with explicit Euler in time yields a stable and monotone scheme.

Comparing J_h^{ghost} and J_h^{hyp} , one observes that the location of the jump terms has been moved. The stabilization term J_h^{hyp} adds a new flux between cut cells k_1 and k_2 with the size of the flux depending on the jump between cell k_1 and its inflow neighbor $k-1$, i.e., the outflow neighbor k_2 of the small cut cell k_1 obtains information from k_1 's inflow neighbor. This way, we implicitly restore the proper domain of dependence of cell k_2 . Another way to think of our new stabilization is that all the mass that exceeds the capacity of the small cut cell k_1 is directly passed on to its neighbor k_2 .

REFERENCES

- [1] C. Helzel, M. J. Berger, R. J. LeVeque, *A high-resolution rotated grid method for conservation laws with embedded geometries*, SIAM J. Sci. Comput. **26** (2005), 785–809.
- [2] E. Burman, *Ghost penalty*, C. R. Math. Acad. Sci. Paris **348** (2010), 1217–1220.
- [3] C. Engwer, S. May, A. Nüßing, F. Streitbürger. *A stabilized DG cut cell method for discretizing the linear transport equation*. Submitted. Preprint available under: Ergebnisberichte des Instituts für Angewandte Mathematik, TU Dortmund University, **605** (2019). <http://dx.doi.org/10.17877/DE290R-20076>

Conservation and Balance Laws in Domains with Boundaries

ELENA ROSSI

We consider the Initial Boundary Value Problem (IBVP) for a balance law in several space dimensions

$$(1) \quad \begin{cases} \partial_t u + \nabla \cdot f(t, x, u) = F(t, x, u) & (t, x) \in]0, T[\times \Omega \\ u(0, x) = u_o(x) & x \in \Omega \\ u(t, \xi) = u_b(t, \xi) & (t, \xi) \in]0, T[\times \partial\Omega \end{cases}$$

where Ω is an open bounded subset of \mathbb{R}^N . We underline that in (1) the boundary condition is required to be satisfied in a weak sense, and this constitutes a major issue when dealing with problems of the type of (1).

The starting point for the study of this IBVP is clearly the definition of solution. In the literature, various definitions of solution to problem (1) are available, and we focus on four of them, highlighting differences and analogies.

The first definition is the one given by Bardos, le Roux and Nédélec in [1]. Their idea is to extend Kružkov's definition of solution to the initial value problem (IVP) on all \mathbb{R}^N to account for the boundary condition. To this aim, in the integral inequality characterising the definition of solution, there is an additional term, which is an integral on the boundary of Ω , involving the boundary datum as well as the trace of the solution at the boundary. To complete the symmetry with IVPs on all \mathbb{R}^n , the second definition under consideration is the analogous in bounded domains to the definition of weak entropy solutions, involving classical entropy–entropy flux pairs, see [4, Definition 2.5]. As for the definition by Bardos *et al.* also this definition requires the solution to admit a trace at the boundary.

Aiming for less regular solution, in particular in \mathbf{L}^∞ , Otto [8] proposes a definition of solution to (1) based on *boundary entropy–entropy flux pairs*, in the case of autonomous scalar conservation laws, see also [6, Chapter 2]. A generalisation of his definition to non autonomous balance laws is provided in [9, Definition 3.3]. Still looking for solutions in \mathbf{L}^∞ , Vovelle [11] and Martin [7] introduce a definition of solution to (1) based on the so-called Kruřkov semi-entropy–entropy flux pairs. These latter two definitions share the remarkable feature of being stable under convergence in \mathbf{L}^1 .

We investigate the relations among these definitions in [9]. The pairwise equivalence of definitions of solutions with the same regularity is almost immediate. After a careful analysis of how the boundary conditions are fulfilled according to each definition, we are able to prove the equivalence among all the definitions considered, under the hypothesis that the solution admits a trace at the boundary, see [9, Theorem 5.8].

We recall that well-posedness results about problem (1) are available under different hypotheses on the flux f and on the source term, and under different regularity assumptions on the initial and boundary data, see for instance [1, 4, 6, 7].

To complete the frame of the study of this IBVP, what is missing is the dependence of the solutions on the flux and on the source term: calling u the solution to (1) and v the solution to the IBVP with flux g and source G , the aim is to find a bound from above to $\|u(t) - v(t)\|_{\mathbf{L}^1(\Omega; \mathbb{R})}$, for $t \in]0, T[$, in terms of some distance between the flux functions f, g and of some distance between the sources F, G . We begin the study of this problem by focusing on particular cases in one space dimension, see [2, 5], and only recently we have managed to get the result for a general one-dimensional IBVP, see [10].

In particular, the domain Ω is now the bounded interval $]a, b[$, the flux and the source are smooth functions, and the initial and boundary data are bounded functions with bounded total variation. The existence of solutions is obtained from the convergence of a Lax–Friedrichs type algorithm, together with operator splitting to account for the source term. This procedure allows to obtain also some *a priori* estimates on the solution to the IBVP, such as an optimal \mathbf{L}^∞ -bound and an estimate on the total variation. The uniqueness follows from the Lipschitz continuous dependence of the solutions on the initial and boundary data [4, Theorem 4.3], a result which is valid also in the multi-dimensional case. Finally, the stability result follows from an application of Kruřkov’s doubling of variables method, together with a careful treatment of the boundary terms.

As far as the multi-dimensional IBVP is concerned, up to now stability estimates are available only in the particular case of linear conservation laws with homogeneous boundary conditions, see [3].

REFERENCES

- [1] C. Bardos, A.Y. le Roux and J.-C. Nédélec, *First order quasilinear equations with boundary conditions*, Comm. Partial Differential Equations, **4**(9) (1979), 1017–1034.
- [2] R.M. Colombo, E. Rossi, *IBVPs for scalar conservation laws with time discontinuous fluxes*, Math. Methods Appl. Sci., **41**(4) (2018), 1463–1479.

- [3] R.M Colombo, E. Rossi, *Nonlocal conservation laws in bounded domains*, SIAM J. Math. Anal., **50**(4) (2018), 4041–4065.
- [4] R.M. Colombo, E. Rossi, *Rigorous estimates on balance laws in bounded domains*, Acta Math. Sci. Ser. B Engl. Ed., **35**(4) (2015), 906–944.
- [5] R.M. Colombo, E. Rossi, *Stability of the 1D IBVP for a non autonomous scalar conservation law*, to appear on Proc. Roy. Soc. Edinburgh Sect. A.
- [6] J. Málek, J. Nečas, M. Rokyta and M. Růžička, *Weak and Measure-Valued Solutions to Evolutionary PDEs*, vol. 13 of Applied Mathematics and Mathematical Computation, (Chapman & Hall, London, 1996).
- [7] S. Martin, *First order quasilinear equations with boundary conditions in the L^∞ framework*, J. Differential Equations, **236**(2) (2007), 375–406.
- [8] F. Otto, *Initial-boundary value problem for a scalar conservation law*, C. R. Acad. Sci. Paris Sér. I Math., **322**(8) (1996), 729–734.
- [9] E. Rossi, *Definitions of solution to the IBVP for multiD scalar balance laws*, J. Hyperbolic Differ. Equ., **15**(2) (2018), 349–374.
- [10] E. Rossi, *Well-posedness of general 1D IBVP for scalar balance laws*, Discrete Contin. Dyn. Syst., **39**(6) (2019), 3577–3608.
- [11] J. Vovelle, *Convergence of finite volume monotone schemes for scalar conservation laws on bounded domains*, Numer. Math., **90**(3) (2002), 563–596.

The multi-dimensional Burgers Equation with L^p Initial Data

DENIS SERRE

(joint work with Luis Silvestre)

We consider scalar conservation laws $\partial_t u + \operatorname{div}_y \vec{f}(u) = 0$ in $n \geq 1$ space dimensions. The Cauchy problem is known to be well-posed for data u_0 in $L^\infty(\mathbb{R}^n)$, after the seminal work by S. Kružkov [3]. The map $u_0 \mapsto u(t)$ defines a semi-group $(S_t)_{t \geq 0}$ over L^∞ , which displays various properties. On the one hand, $S_t(L^\infty \cap L^p) \subset L^\infty \cap L^p$ and $t \mapsto \|S_t u_0\|_p$ is non-increasing. In the case $p = \infty$, this includes the maximum principle. On the other hand if $u_0 - v_0$ is integrable, then $S_t u_0 - S_t v_0$ is too and $t \mapsto \|S_t u_0 - S_t v_0\|_1$ is non-increasing. An important consequence is that the semi-group extends by continuity to the space $L^1(\mathbb{R}^n)$.

When $u_0 \in L^1(\mathbb{R}^n)$ (but is not necessarily bounded), it is tempting to say that $u(t, y) := (S_t u_0)(y)$ is the solution of the Cauchy problem associated with the datum u_0 . However, as remarked by M. Crandall [1], it is unclear whether $\vec{f}(u)$ is locally integrable, and at this stage we may not say that u really solves the PDE in the distributional sense. It is therefore crucial to investigate further integrability properties of this *formal solution*.

When \vec{f} is globally Lipschitz, there is no problem at all ; this includes the rather obvious linear case. On the contrary, the example of the 1-D Burgers equation ($n = 1$ and $f(u) = \frac{1}{2}u^2$) for which C. Dafermos [2] proved

$$\|u(t)\|_\infty \leq 2 \sqrt{\frac{\|u_0\|_1}{t}}$$

shows that a reasonable amount of nonlinearity can force enough integrability of the formal solution, that it be a genuine distributional solution, even satisfying Kruřkov’s entropy conditions.

The key estimate follows from a careful application of our theory of Compensated Integrability. We form the symmetric matrix $M(s) \in \mathbf{Sym}_{1+n}(\mathbb{R})$ by setting

$$m_{00} = s, \quad m_{0j} = f_j(s), \quad \frac{dm_{ij}}{ds} = f'_i(s)f'_j(s).$$

We may assume that $M(0) = 0_{1+n}$. The map $s \mapsto M(s)$ is increasing for the natural order in \mathbf{Sym}_{1+n} . It is strictly increasing whenever the flux is non-degenerate: If $s < \bar{s}$ then $M(s) \leq M(\bar{s})$, and the difference $M(\bar{s}) - M(s)$ is positive definite if and only if the graph of \vec{f} over $[s, \bar{s}]$ is not contained in a hyperplane.

When $u_0 \in L^1 \cap L^\infty$, then the row-wise space-time divergence of $T := M(u)$ has finite mass over $(0, \tau) \times \mathbb{R}^n$. If moreover $u_0 \geq 0$ (we can always restrict to this case, thanks to the maximum principle), then T is positive and CI applies, in the form

$$\int_0^\tau \int_{\mathbb{R}^n} (\det T)^{\frac{1}{n}} dy dt \leq c_n (\|T_{0\bullet}\|_{L^1, t=0} + \|T_{0\bullet}\|_{L^1, t=\tau})^{1+\frac{1}{n}}.$$

This yields a Strichartz-like inequality.

Let us consider the multi-D Burgers equation, which is a paradigm for non-degenerate fluxes ; it has

$$f_1(s) = \frac{u^2}{2}, \quad f_n(s) = \frac{u^{n+1}}{n+1}.$$

The procedure above yields the more general inequality for every exponent $p \in [1, \infty)$

$$\left(\int_0^\tau \int_{\mathbb{R}^n} u^{p^*} dy dt \right)^{\frac{n}{n+1}} \leq c_{n,p} \left(\int_{\mathbb{R}^n} u_0^p dy \cdot \int_{\mathbb{R}^n} u_0^{p+n} dy \right)^{\frac{1}{2}},$$

where $p^* := \frac{n+1}{n}(p+n)$. Shifting the initial time, we can interpret this as a differential inequality for an appropriate function of time. Then a Gronwall argument yields our fundamental dispersion estimate: If $1 \leq p < q < \infty$, then

$$\|u(t)\|_q \leq c_{n,p,q} t^{-\beta} \|u_0\|^\alpha$$

where $\alpha, \beta > 0$ are rational functions of p, q and n ; see our paper [5]. Finally, this decay can be combined with a De Giorgi-type estimate to establish the corresponding decay with now $q = \infty$.

As a consequence, the semi-group extends by continuity to every space L^p , and the corresponding formal solutions are genuine entropy solutions of the Cauchy problem.

REFERENCES

- [1] M. Crandall. The semigroup approach to first order quasilinear equations in several space variables. *Israel J. Math.*, **12** (1972), pp 108–132.
- [2] C. Dafermos. Characteristics in hyperbolic conservation laws. *Nonlinear Analysis and Mechanics: Heriot-Watt Symposium (Edinburgh 1976)*, Vol. I, pp 1–58, ed. R. J. Knops. Research Notes in Math., No 17, Pitman, London (1977).

- [3] S. Kružkov. First order quasilinear equations with several independent variables (in Russian). *Mat. Sbornik (N.S.)*, **81 (123)** (1970), pp 228–255.
- [4] D. Serre. Compensated integrability. Applications to the Vlasov–Poisson equation and other models in mathematical physics. Preprint arXiv:1803.02641. To appear in *Journal de Mathématiques Pures et Appliquées*.
- [5] D. Serre, L. Silvestre. Multi-dimensional Burgers equation with unbounded initial data: well-posedness and dispersive estimates. Preprint arXiv:1808.07467. Submitted.

Scalar Conservation Laws with Regulated Flux

WEN SHEN

(joint work with Alberto Bressan, Graziano Guerra)

We consider the Cauchy problem for a scalar conservation law:

$$(1) \quad u_t + f(\alpha(t, x), u)_x = 0, \quad u(0, x) = \bar{u}(x).$$

Here, the mappings $\omega \mapsto f(\alpha, \omega)$ and $\alpha \mapsto f(\alpha, \omega)$ are smooth, but $\alpha(\cdot, \cdot)$ can be rough (to be specified later). As an application we mention the triangular system:

$$(2) \quad \begin{cases} \alpha_t + g(\alpha)_x = 0, & \alpha(0, x) = \bar{\alpha}(x), \\ u_t + f(\alpha, u)_x = 0, & u(0, x) = \bar{u}(x). \end{cases}$$

The solution for (2) can be obtained by first solving the scalar conservation law for α , and then plugging α in the second equation and solve for u . Note that $\alpha(\cdot, \cdot)$ can contain jumps and complicated wave patterns.

The eigenvalues of the Jacobian matrix for the flux function for (2) are $\lambda_1 = g'(\alpha)$ and $\lambda_2 = f_u(\alpha, u)$. When $\lambda_1 = \lambda_2$, the system in (2) loses hyperbolicity, and standard theory on hyperbolic conservation laws does not apply.

Numerous literatures on the existence and uniqueness of solutions for (1) exist for special simple cases: (i) $\alpha = a(x)$ is piecewise smooth with finitely many jumps [1]; and (ii) $\alpha(t, x) = a(x)b(t)$ where a is as in (i) and b has bounded variation [3]. See also related works [4, 6, 7].

We are interested in the more complicated case where α is possibly the solution of a scalar conservation law. The main objective of our work is the convergence of the viscous approximations, as $\varepsilon \rightarrow 0$, of the viscous equation

$$(3) \quad u_t + f(\alpha(t, x), u)_x = \varepsilon u_{xx}, \quad u(0, x) = \bar{u}(x)$$

to a unique weak solution to the conservation law (1) with the same initial datum.

As a building block, we utilize the result in [5] for flux functions with one discontinuity in x :

$$u_t + f(x, u)_x = 0, \quad u_t^\varepsilon + f(x, u^\varepsilon)_x = \varepsilon u_{xx}^\varepsilon, \quad f(x, \omega) = \begin{cases} f^L(\omega) & \text{if } x \leq 0, \\ f^R(\omega) & \text{if } x > 0. \end{cases}$$

In this simpler case, the existence and uniqueness of the vanishing viscosity limit to the entropy solution of the scalar conservation law is established in [5].

We now consider more general flux functions. A function of a single variable $\alpha : \mathbb{R} \mapsto \mathbb{R}$ is called *regulated* if it admits left and right limits at every point. We

remark that, a function α is *regulated* if and only if for every interval $[x_1, x_2]$ and every $\epsilon > 0$ there exists a piecewise constant function φ such that

$$\|\varphi - \alpha\|_{\mathbf{L}^\infty([x_1, x_2], \mathbb{R})} < \epsilon.$$

We extend this definition to functions of two variables. A bounded function $\alpha = \alpha(t, x)$ is called *2D-regulated* if, for every intervals $[x_1, x_2]$ and $[0, T]$ and any $\epsilon > 0$, the following holds. There exist finitely many disjoint subintervals $[a_i, b_i] \subseteq [0, T]$, Lipschitz continuous curves $\gamma_{i,1}(t) < \gamma_{i,2}(t) < \dots < \gamma_{i,N(i)}(t)$, $t \in [a_i, b_i]$, and constants $\alpha_{i,0}, \alpha_{i,1}, \dots, \alpha_{i,N(i)}$ such that

- (i) The intervals $[a_i, b_i]$ cover most of $[0, T]$, such that $T - \sum_i (b_i - a_i) \leq \epsilon$;
- (ii) For every i, k , $\frac{d}{dt} \gamma_{i,k}(t)$ coincides a.e. with a regulated function;
- (iii) For every $t \in [a_i, b_i]$, the step function

$$\chi_i(t, x) \doteq \begin{cases} \alpha_{i,0}, & \text{if } x < \gamma_{i,1}(t), \\ \alpha_{i,k}, & \text{if } \gamma_{i,k}(t) < x < \gamma_{i,k+1}(t), \quad k = 1, 2, \dots, N(i) - 1, \\ \alpha_{i,N(i)}, & \text{if } \gamma_{i,N(i)}(t) < x, \end{cases}$$

satisfies

$$\|\chi_i(t, \cdot) - \alpha(t, \cdot)\|_{\mathbf{L}^\infty([x_1, x_2])} \leq \epsilon.$$

See next figure for an illustration.

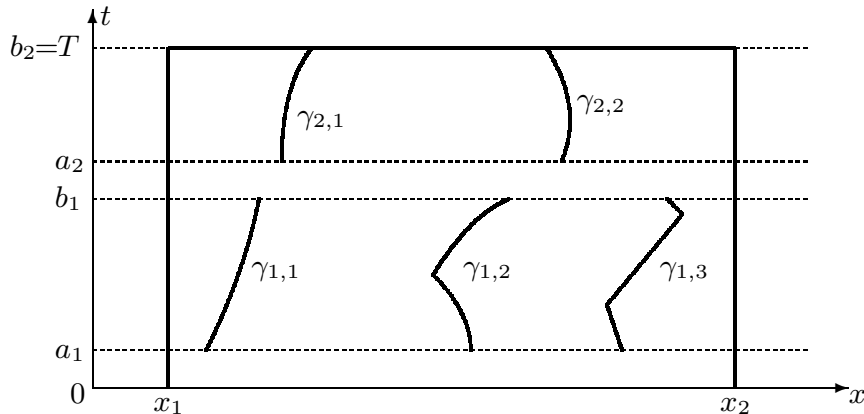

We now state one of the main result in [2]. Consider the assumptions:

- (A1) The map $\alpha \mapsto f(\alpha, u)$ is smooth, and the map $u \mapsto f(\alpha, u)$ is Lipschitz;
- (A2) $f(\alpha, 0) = 0$ and $f(\alpha, 1) = C$ independent of α ;
- (A3) $\alpha(t, x)$ is a 2D-regulated function;
- (A4) $\alpha(t, x)$ has bounded variation, and $u \rightarrow f(\alpha, u)$ is nonlinear, i.e., $f_{uu} = 0$ only at isolated points of u .

Under (A1)–(A3), we prove the convergence of u^ϵ to a unique weak limit. Adding (A4), we obtain the existence of a unique strong limit of $u^\epsilon \rightarrow u$ in \mathbf{L}^1_{loc} .

The convergence proof (and thus the existence) is obtained through a compensated compactness argument. The proof for the uniqueness relies on comparison principles for the integrated function $U^\epsilon(t, x) \doteq \int_{-\infty}^x u^\epsilon(t, \xi) d\xi$, which satisfies a Hamilton-Jacobi equation

$$U_t^\epsilon + f(t, x, U_x^\epsilon) = \epsilon U_{xx}, \quad U^\epsilon(0, x) = \bar{U}(x).$$

Let $U^{\sharp,\varepsilon}$ be the corresponding solution with flux f^\sharp and initial datum $\bar{U}^\sharp(x)$. Assuming that there exists a constant $\bar{\eta} > 0$ and a function $\eta(t) \in \mathbf{L}^\infty$ such that

$$\begin{cases} f^\sharp(t, x, \omega) \leq f(t, x, \omega) + \eta(t) & \text{for all } (t, x, \omega), \\ \bar{U}(x) \leq \bar{U}^\sharp(x) + \bar{\eta} & \text{for all } x, \end{cases}$$

then for all $t \in [0, T]$ and $x \in \mathbb{R}$, one has the comparison principle

$$(4) \quad U^\varepsilon(t, x) \leq U^{\sharp,\varepsilon}(t, x) + \bar{\eta} + \int_0^t \eta(s) ds.$$

This implies, if f and f^\sharp are “uniformly” close, then the corresponding solutions U^ε and $U^{\sharp,\varepsilon}$ are close in the uniform norm. Note that uniform convergence of U^ε corresponds to weak convergence of the solution u^ε of the viscous equation (2).

Define \mathcal{F} as the set of fluxes for which the solution u^ε has a unique weak limit as $\varepsilon \rightarrow 0$. Observe that \mathcal{F} is closed under “uniform” convergence, in the sense of the definition of the 2D-regulated functions. Furthermore, the set \mathcal{F} is non-empty thanks to [5], containing fluxes with one jump. By repeated applying the comparison principle (4), we show that the set \mathcal{F} includes fluxes that can be approximated uniformly by piecewise constant fluxes. Hence \mathcal{F} includes 2D-regulated flux functions.

The next result concerns the regularity of solutions to a scalar conservation law

$$\alpha_t + g(\alpha)_x = 0, \quad t \in [0, T], \quad x \in \mathbb{R}, \quad \alpha(0, x) = \bar{\alpha}(x), \quad x \in \mathbb{R}.$$

Let the flux function g be twice continuously differentiable, and assume that either one of the following holds:

- (C1) $\bar{\alpha} \in \mathbf{L}^\infty(\mathbb{R})$ and $g''(s) > 0$ for all $s \in \mathbb{R}$;
- (C2) $\bar{\alpha}$ has bounded variation and there exists a value $\bar{s} \in \mathbb{R}$ such that $g''(s) < 0$ for $s < \bar{s}$ and $g''(s) > 0$ for $s > \bar{s}$.

Then the unique entropy weak solution $\alpha = \alpha(t, x)$ is a 2D-regulated function.

Combining the two results, we achieve existence and uniqueness of the vanishing viscosity solutions for the triangular system (2), under the suitable assumptions.

REFERENCES

- [1] B. Andreianov, K. H. Karlsen, and N. H. Risebro. A theory of L^1 -dissipative solvers for scalar conservation laws with discontinuous flux. *Arch. Rat. Mech. Anal.* **201** (2011), 27–86.
- [2] A. Bressan, G. Guerra and W. Shen. “Vanishing Viscosity Solutions for Conservation Laws with Regulated Flux”. *J. Differential Equations* **266** (2019), 312–351.
- [3] G. M. Coclite and N. H. Risebro, Conservation laws with time dependent discontinuous coefficients. *SIAM J. Math. Anal.* **36** (2005), 1293–1309.
- [4] T. Gimse and N. H. Risebro, Riemann problems with a discontinuous flux function. In *Proc. third HYP*. (1991), pp. 488-502.
- [5] G. Guerra and W. Shen. “Backward Euler Approximations for Conservation Laws with Discontinuous Flux”. Preprint 2018. Accepted for publication in *SIAM J. Math Anal.* (2019).

- [6] G. Guerra and W. Shen. “Vanishing Viscosity Solutions of Riemann Problems for Models of Polymer Flooding”. *Non-linear partial differential equations, mathematical physics, and stochastic analysis*, 261–285, EMS Congress Report (2018).
- [7] W. Shen. “On the Uniqueness of Vanishing Viscosity Solutions for Riemann Problems for Polymer Flooding”. *NoDEA* **24** (2017), no. 4, 2280–2316.

Anticipation Dynamics

EITAN TADMOR

(joint work with Ruiwen Shu)

We study the system of ‘social particles’ driven by a radial potential $U(|\cdot|)$ and Hamiltonian $\mathcal{H}_N(\mathbf{x}_1^\tau, \dots, \mathbf{x}_N^\tau) := \frac{1}{2N} \sum_{j,k} U(|\mathbf{x}_j^\tau - \mathbf{x}_k^\tau|)$ where $\mathbf{x}_i^\tau := \mathbf{x}_i + \tau \mathbf{v}_i(t)$ are the *anticipated* position of particle i at time $t + \tau$,

$$(AT) \quad \begin{cases} \dot{\mathbf{x}}_i(t) = \mathbf{v}_i \\ \dot{\mathbf{v}}_i(t) = -\frac{1}{N} \sum_j \nabla U(|\mathbf{x}_i^\tau(t) - \mathbf{x}_j^\tau(t)|). \end{cases}$$

The case $\tau = 0$ corresponds to the N -body problem. We focus on $\tau > 0$: expanding in (small) τ leads to

$$(\Phi U) \quad \begin{cases} \dot{\mathbf{x}}_i(t) = \mathbf{v}_i \\ \dot{\mathbf{v}}_i(t) = \frac{\tau}{N} \sum_j \Phi_{ij}(\mathbf{v}_j(t) - \mathbf{v}_i(t)) - \frac{1}{N} \sum_j \nabla U(|\mathbf{x}_i(t) - \mathbf{x}_j(t)|) \end{cases}$$

with $\Phi_{ij} = D^2U(|\mathbf{x}_i^{\tau_{ij}} - \mathbf{x}_j^{\tau_{ij}}|)$. The mid-values $\tau_{ij} \in (0, \tau)$ are not accessible. We therefore study the so-called general ΦU -class, where $\Phi_{ij} = \Phi((\mathbf{x}_i, \mathbf{v}_i), (\mathbf{x}_j, \mathbf{v}_j)) \in \text{Symm}_{n \times n}$. We begin by noting that anticipation provides a systematic framework for the derivation of alignment, attraction and repulsion. Indeed, we rewrite

$$(\Phi U) \quad \begin{cases} \dot{\mathbf{v}}_i(t) = \overbrace{\frac{\tau}{N} \sum_j \Phi_{ij}(\mathbf{v}_j(t) - \mathbf{v}_i(t))}^{\text{Anticipation} \rightsquigarrow \text{Alignment } (\Phi)} - \overbrace{\frac{1}{N} \sum_j \nabla U(|\mathbf{x}_i(t) - \mathbf{x}_j(t)|)}^{\text{Pairwise interactions } (U)} \end{cases}$$

with the class of communication kernels — $\Phi_{ij} = \Phi(\mathbf{x}_i, \mathbf{x}_j, \mathbf{v}_i, \mathbf{v}_j) \mid \Phi_{ij} = \Phi_{ji}$. The model of anticipation correspondences to $\Phi_{ij} = D^2U(|\mathbf{x}_i^{\tau_{ij}} - \mathbf{x}_j^{\tau_{ij}}|)$. Linearization ($\tau_{ij} = 0$) yields

$$\Phi_{ij} = D^2U(|\mathbf{x}_i - \mathbf{x}_j|) = \frac{U'(r_{ij})}{r_{ij}} I + \left(U''(r_{ij}) - \frac{U'(r_{ij})}{r_{ij}} \right) \mathbf{x}_{ij} \mathbf{x}_{ij}^\top, \quad \mathbf{x}_{ij} = \frac{\mathbf{x}_i - \mathbf{x}_j}{r_{ij}}.$$

It contains a *scalar communication* along $\overrightarrow{\mathbf{x}_i \mathbf{x}_j}$ corresponding to the celebrated Cucker-Smale (2007):

$$(CS) \quad \dot{\mathbf{v}}_i(t) = \frac{\tau}{N} \sum_j \phi_{ij}(\mathbf{v}_j(t) - \mathbf{v}_i(t)), \quad \phi_{ij} = \phi(|\mathbf{x}_i - \mathbf{x}_j|) \leftarrow \frac{U'(r_{ij})}{r_{ij}}.$$

Note that anticipation correlates both the positions $\overline{\mathbf{x}_i \mathbf{x}_j}$ and velocities $\overline{\mathbf{v}_i \mathbf{v}_j}$.

The large time behavior of such systems is driven by flocking and concentration. We begin with the prototypical example of of Cucker-Smale system:

$$\dot{\mathbf{v}}_i(t) = \frac{\tau}{N} \sum_j \phi(|\mathbf{x}_i - \mathbf{x}_j|)(\mathbf{v}_j(t) - \mathbf{v}_i(t)) - \frac{1}{N} \sum_j \frac{U'(r_{ij})}{r_{ij}}(\mathbf{x}_i - \mathbf{x}_j)$$

Assuming a ‘fat-tailed’ kernel (here and below $\langle r \rangle := (1 + r^2)^{1/2}$): $\phi(r) \geq \langle r \rangle^{-\gamma} \leftarrow U''(r) \geq \langle r \rangle^{-\gamma}$, $\gamma \leq 1$, then the system experiences flocking, so that $|\mathbf{v}_i(t) - \bar{\mathbf{v}}| \xrightarrow{t \rightarrow \infty} 0$ where $\bar{\mathbf{v}} := \frac{1}{N} \sum_j \mathbf{v}_j$. Additional pairwise interactions to be considered are divided into two regimes of $\frac{U'(r)}{r} < 0$ (repulsion) and $\frac{U'(r)}{r} > 0$ (attraction). Attraction leads to confinement: $\mathbf{v}_j(t) - \bar{\mathbf{v}} \delta(\mathbf{x}_j(t) - \bar{\mathbf{x}}) \xrightarrow{t \rightarrow \infty} 0$.

This motivates our study of emergence of flocking in general anticipation dynamics. We exclude short-range singular kernel, assuming $U(0) = U'(0) = 0$, D^2U is bounded: $|U''(r)| \leq A$. We study fat-tailed (purely) attractive potentials: $\frac{U'(r)}{r} \geq \langle r \rangle^{-\beta}$. In particular — fat-tailed convex potentials: $U''(r) \geq \langle r \rangle^{-\beta}$.

Our first result deals with flocking of general ΦU -systems with convex potentials.

Thm 1 (Alignment+Attraction w-convex potential).

Consider the system $\dot{\mathbf{v}}_i(t) = \frac{\tau}{N} \sum_j \Phi_{ij}(\mathbf{v}_j - \mathbf{v}_i) - \frac{1}{N} \sum_j \nabla U(|\mathbf{x}_i - \mathbf{x}_j|)$ with fat-

$$\text{tails, } \begin{cases} \text{Convex potential} & U''(r_{ij}) \geq \langle r_{ij} \rangle^{-\beta} \\ \text{Long-range alignment} & \Phi_{ij} \geq \langle r_{ij} \rangle^{-\gamma} \end{cases} \quad (r_{ij} = |\mathbf{x}_i - \mathbf{x}_j|).$$

Then the energy fluctuations, $\delta E(t) := \frac{1}{2N} \sum_i |\mathbf{v}_i - \bar{\mathbf{v}}|^2 + \frac{1}{2N^2} \sum_{i,j} U(|\mathbf{x}_i - \mathbf{x}_j|)$,

satisfy *flocking+concentration*: $\delta E(t) \leq e^{-t^{1-\eta}}$, $\eta = \frac{2 \max\{\beta, \gamma\}}{4-3\beta} < 1$

The proof proceeds in three main steps:

- (1) Diameter of positions: $\max_i |\mathbf{x}_i(t)| \leq \langle t \rangle^{\frac{2}{4-3\beta}}$
- (2) Partial coercivity: $\frac{d}{dt} \delta E(t) = \frac{d}{dt} E(t) \leq -\frac{\tau}{2N} \langle t \rangle^{-\frac{2\gamma}{4-3\beta}} \sum_i |\mathbf{v}_i(t) - \bar{\mathbf{v}}|^2$
- (3) Hypo-coercivity: $\widehat{E}(t) := E(t) + \langle t \rangle^{-\eta} \times \frac{1}{N} \sum \mathbf{x}_i(t) \cdot \mathbf{v}_i(t)$

We mention two special cases.

Cor 1. ANTICIPATION (with convex potential). Consider

$$\dot{\mathbf{v}}_i(t) = \frac{\tau}{N} \sum_j D^2U(|\mathbf{x}_i^{\tau_{ij}} - \mathbf{x}_j^{\tau_{ij}}|)(\mathbf{v}_j - \mathbf{v}_i) - \frac{1}{N} \sum_j \nabla U(|\mathbf{x}_i - \mathbf{x}_j|)$$

with fat-tail: $U''(r) \geq \langle r \rangle^{-\beta} \rightsquigarrow \Phi_{ij} \geq \langle |\mathbf{x}_i - \mathbf{x}_j| \rangle^{-\beta}$ so that $\gamma = \beta$ applies. We deduce flocking+concentration: $\delta E(t) \leq e^{-t^{1-\eta}}, \eta = \frac{2\beta}{4-3\beta}, \beta < \frac{4}{5}$.

Cor 2. ALIGNMENT (Cucker-Smale systems). Consider the Cucker-Smale alignment with *matrix* communication, $\dot{\mathbf{v}}_i(t) = \frac{\tau}{N} \sum_j \Phi_{ij}(\mathbf{v}_j - \mathbf{v}_i)$. Then a fat-tailed

communication $\Phi_{ij} \geq \langle |\mathbf{x}_i - \mathbf{x}_j| \rangle^{-\gamma}$ implies flocking: $\delta E(t) \leq e^{-t^{1-\eta}}$ with $\eta = \frac{3\gamma}{2}, \delta E(t) := \frac{1}{2N} \sum_i |\mathbf{v}_i(t) - \bar{\mathbf{v}}|^2$.

Next we consider the flocking anticipation with fat-tailed attraction $\frac{U'(r)}{r} \geq \langle r \rangle^{-\beta}$.

Thm 2 (Anticipation w-attraction). Consider $\dot{\mathbf{v}}_i(t) = -\frac{1}{N} \sum_j \nabla U(|\mathbf{x}_i^\tau - \mathbf{x}_j^\tau|)$.

Then the anticipated fluctuations:

$$\delta \mathcal{E}(t) := \frac{1}{2N} \sum_i |\mathbf{v}_i - \bar{\mathbf{v}}|^2 + \frac{1}{2N^2} \sum_{i,j} U(|\mathbf{x}_i^\tau - \mathbf{x}_j^\tau|)$$

satisfy $\delta \mathcal{E}(t) \leq e^{-t^{1-\eta}}, \eta = \frac{2\beta}{1-2\beta}, \beta < \frac{1}{3}$. The surprising aspect is that $\Phi = D^2U$ need not be positive and $E(t)$ need not decrease.

Finally, we consider the large-crowd anticipation dynamics

$$\mathbf{u}_t + \mathbf{u} \cdot \nabla_{\mathbf{x}} \mathbf{u} = - \int \nabla U(|\mathbf{x}^\tau - \mathbf{y}^\tau|) \rho(\mathbf{y}) d\mathbf{y}, \quad \mathbf{x}^\tau(t) := \mathbf{x} + \tau \mathbf{u}(t, \mathbf{x}).$$

The bookkeeping of *anticipated* energy functional (fluctuations)

$$\delta \mathcal{E}(t) := \iint \left(\frac{1}{2} |\mathbf{u}(t, \mathbf{x}) - \mathbf{u}(t, \mathbf{y})|^2 + \nabla U(|\mathbf{x}^\tau(t) - \mathbf{y}^\tau(t)|) \right) \rho(\mathbf{x}) \rho(\mathbf{y}) d\mathbf{x} d\mathbf{y}$$

is given by

$$\frac{d}{dt} \delta \mathcal{E}(t) = -\tau \int \left| \frac{D}{Dt} \mathbf{u}(t, \mathbf{x}) \right|^2 \rho(t, \mathbf{x}) d\mathbf{x}$$

which yields, for attractive potentials: $\frac{U'(r)}{r} \geq \langle r \rangle^{-\beta}, \beta < \frac{1}{3}$, that the anticipated support $|\mathbf{x}^\tau(t)| \leq \langle t \rangle^\eta$ and hence alignment + concentration follow. Again, the result is surprising since U need not be convex (so $\delta E(t)$ may increase ...)

REFERENCES

[1] R. Shu & ET, Anticipation breeds alignment (2019), arXiv:1905.00633.

Elements of an Enhanced Shallow Flow Modeling Framework

MANUEL TORRILHON

(joint work with Julia Kowalski)

Mathematical shallow flow models are successfully applied in a wide range of scientific fields, like numerical weather forecasting, free-surface hydraulics in rivers and natural hazard simulations such as snow avalanches or landslides, see e.g. [6]. Beyond the geosciences they are relevant to compute granular transport processes in chemical engineering, or in production engineering to model coating processes.

Here, shallowness typically refers to the fact that the flow's vertical extent is much smaller than its horizontal extent. This motivates a suitably chosen vertical average and eventually leads to a computationally efficient depth-averaged model of reduced complexity. The most famous depth-averaged flow model is certainly the classical shallow water system. In its one dimensional formulation it is traditionally known as the Saint-Venant equations [6].

Quite naturally any shallow flow formulation comes at the price of losing vertical information, such as information on the velocity profile. This is not critical if the velocity profile is constant throughout the flow depth and vertical acceleration can be neglected. In the geophysical flow context such a situation is often referred to as 'plug-flow'. In many realistic situations, however, velocity profiles deviate significantly from a vertically constant value.

The computational shallow flow community encounters this obvious modeling error by introducing the concept of a shape factor [6]. The shape factor is determined based on an assumed parametrization of the velocity profile. Though this serves as a first order correction, it is also restrictive, as the chosen parametrization, say a linear velocity profile, is assumed to be an appropriate choice throughout the duration of the flow which is typically not the case.

In our work we address this problem and propose a shallow flow formulation based on vertical moments. Moment methods proved to be a powerful tool and have been successfully applied in various scientific fields, such as in rarefied gas dynamics [7]. In the shallow flow context, moment methods allow physical information on the vertical flow structure to be preserved, while still being able to use depth-averaging to simplify and reduce the complexity of the system. In [3], we focused presented a fundamental analysis and validation of a generic model cascade shallow flows based on moment equations.

While classical shallow flow theory replaces the velocity components u and v by their integral means u_m and v_m , in our approach we retain selected aspects of the otherwise lost information about the vertical velocity profile in z -direction by assuming a polynomial expansion of the velocity components. It is given by

$$(1) \quad u(x, y, z, t) = u_m(x, y, t) + \sum_{j=1}^N \alpha_j(x, y, t) \phi_j(z)$$

$$(2) \quad v(x, y, z, t) = v_m(x, y, t) + \sum_{j=1}^N \beta_j(x, y, t) \phi_j(z)$$

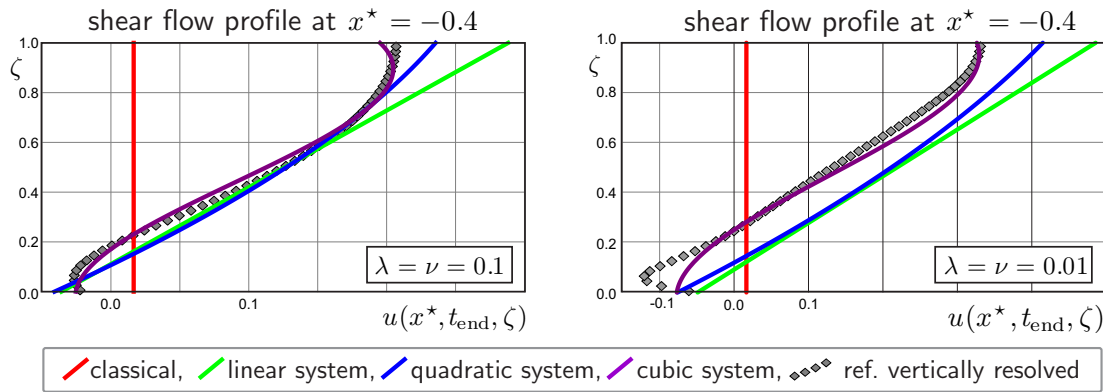

FIGURE 1. Approximation of a vertical velocity profile with successive moment models of shallow flow. Symbols are obtained from a vertically resolved reference solution. The linear model corresponds to $N = 1$, the quadratic model to $N = 2$, etc.

with appropriate polynomials $\phi_j(z)$, $j = 1, \dots, N$. The classical depth-averaged integral mean velocity values u_m and v_m can hence be considered as zeroth order moments and the complete z -profile of u and v will now be modeled by the 2d functions $u_m(x, y, t)$ and $v_m(x, y, t)$ and the coefficients $\alpha_j(x, y, t)$ and $\beta_j(x, y, t)$ for $j = 1, \dots, N$. The number N will indicate the quality of the model and we will derive concrete partial differential equations for the coefficients for moderate values of N which may replace standard depth-averaged shallow flow models. Details regarding this approach including the generic formulation of the entire model can be read in [3].

A crucial aspect is the validation of the models and the study of their physical accuracy. For this purpose we derived a tailored reference system that is able to provide synthesized data to evaluate the accuracy of the models in numerical simulations. The reference system is based on non-averaged Navier-Stokes equations, hence vertically resolving the z -profiles of the velocity field. Both the reference system and the reduced model cascade assumes hydrostatic equilibrium, hence a linear pressure profile. In this way the reference system can be used to precisely evaluate the error of vertical averaging alone. A version of the reference system using a mapped z -coordinate additionally allows a simplified derivation of the model cascade and efficient reference computations. In Fig. 1 flow profiles are compared to their corresponding result as determined from the moment cascade, where the linear model corresponds to $N = 1$, etc. The plots show vertical velocity profiles at two positions of a 1D periodic height perturbation that produces an unsteady wave interaction. An underlying pure shear flow profile is imposed initially and changes its shape due to friction and the wave pattern.

While direct comparison between the shallow flow moment cascade and the reference systems reveals its potential to serve as an elemental building block to a novel shallow flow framework of lower model error, many open challenges remain to be addressed in the future. These include

- Derivation of a globally hyperbolic model: While the zero and the first moment system are hyperbolic, imaginary eigenvalues can emerge for higher order systems. Though it seems the loss of hyperbolicity is mainly restricted to regimes of less physical significance, it still poses a challenge to the numerical solution method. In kinetic gas theory globally hyperbolic moment equations can be derived based on projection techniques [1] or using the maximum entropy approach [4]. Both strategies will be studied in the current context.
- Hierarchical numerical methods: Given the cascading nature of the generated moment models it makes most sense to use only as many moments as is needed for the physical flow context. This requires a numerical method that is able to switch between moment models in different parts of the computational domain, as demonstrated in [8] for the moment equations of the Boltzmann equation, but also appropriate model error estimation.
- Alternative constitutive relations: The current shallow flow cascade assumes a Newtonian rheology of dominant hydrostatic stress components and insignificant viscous and shear contributions. Yet, higher order shear stress contributions can in principle be incorporated, e.g. following [5], and will enable us to investigate their isolated effect on the shallow flow dynamics. Alternative constitutive relations can also be considered within the proposed shallow moment framework, such as the $\mu(I)$ rheology [2].
- Model parameter estimation: Similar to the classical shallow flow theory, also the shallow moment cascade relies on parameters that arise from the chosen material closure. Any application of the model to the re-analysis of even forecast of real flow events, e.g. geological surface flow, will hence require to estimate the model parameters based on data.

REFERENCES

- [1] Y. Fan, J. Koellermeier, J. Li, R. Li, and M. Torrilhon, *Model Reduction of Kinetic Equations by Operator Projection*, J. Stat. Phys. **162**(2), (2015), pp.457–486
- [2] J.M.N.T. Gray and A.N. Edwards, *A depth-averaged $\mu(I)$ -rheology for shallow granular free-surface flows*, J. Fluid. Mech. **755**, pp.503–534 (2014)
- [3] J. Kowalski, and M. Torrilhon, *Moment Approximations and Model Cascades for Shallow Flow*, Commun. Comput. Phys. **25**(3), (2019), pp.669–702
- [4] C.D. Levermore, *Moment closure hierarchies for kinetic theories*, J. Stat. Phys. **83**, (1996), pp.1021–1065
- [5] B. Perthame and J.-F. Gerbeau, *Derivation of viscous Saint-Venant system for laminar shallow water; numerical validation*, Disc. and Cont. Dyn. Sys. - Series B **1**(1), (2001), pp.89–102
- [6] S. Savage and K. Hutter, *The dynamics of avalanches of granular materials from initiation to runout. Part i: Analysis*, Acta Mechanica, **86**(1), (1991), pp.201-223
- [7] M. Torrilhon, *Modeling nonequilibrium gas flow based on moment equations*, Ann. Rev. Fluid Mech. **48**, (2016), pp.429–458.
- [8] M. Torrilhon, N. Sarna, *Hierarchical Boltzmann simulations and model error estimation*, J. Comput. Phys. **342**, (2017), pp.66–84.

High Friction Limits from Euler Flows to Gradient Flows

ATHANASIOS E. TZAVARAS

(joint work with Jan Giesselmann, Corrado Lattanzio, Xiaokai Huo, Ansgar Jüngel)

The talk outlined certain works concerning the high friction limit from Euler flows to gradient flows in a context of gas dynamic models in Eulerian coordinates. Consider the system of Euler equations

$$(1) \quad \begin{aligned} \frac{\partial \rho}{\partial t} + \operatorname{div}(\rho u) &= 0 \\ \frac{Du}{Dt} &:= \frac{\partial u}{\partial t} + (u \cdot \nabla)u = -\nabla \frac{\delta \mathcal{E}}{\delta \rho}(\rho) \end{aligned} \quad x \in \mathbb{R}^d, t > 0,$$

where $\rho \geq 0$ is the density, u the fluid velocity and $m = \rho u$ the momentum flux. The evolution of u is determined via a density functional $\mathcal{E}(\rho)$ and $\frac{\delta \mathcal{E}}{\delta \rho}(\rho)$ stands for the variational derivative of $\mathcal{E}(\rho)$. The induced dynamics formally satisfies the energy conservation equation $\frac{d}{dt} \left(\int \frac{1}{2} \rho |u|^2 dx + \mathcal{E}(\rho) \right) = 0$.

The system (1) has a variational derivation: Fix a domain $D \subset \mathbb{R}^d$ with (reference) density $\bar{\rho}(\xi)$, $\xi \in D$, and a family of maps $x^\delta(\xi, t) : D \rightarrow \Omega_\delta$ mapping D to Ω_δ . Define $u^\delta(x, t)$ to be the velocity of these maps, and $\rho^\delta(x, t)$ the image measures (push-forward) of the density $\bar{\rho}$ through the map x^δ . Consider the extrema of the Lagrangian

$$\mathcal{L}[x^\delta] = \int_{t_0}^{t_1} \int_{x^\delta(D)} \frac{1}{2} \rho^\delta |u^\delta|^2 dx dt - \int_{t_0}^{t_1} \mathcal{E}[\rho^\delta] dt$$

taken over maps such that $x^\delta|_{t=t_0} = x_0$, $x^\delta|_{t=t_1} = x_1$, Then the critical (ρ, u) satisfies the system (1).

The variational structure induces a relative energy calculation [1] that is often useful in comparing two solutions of such systems, see [1]. Namely, let (ρ, u) and $(\bar{\rho}, \bar{u})$ be two solutions of (1) and

$$\mathcal{E}(\rho|\bar{\rho}) := \mathcal{E}(\rho) - \mathcal{E}(\bar{\rho}) - \left\langle \frac{\delta \mathcal{E}}{\delta \rho}(\bar{\rho}), \rho - \bar{\rho} \right\rangle,$$

Under the assumption: there exists a functional $S[\rho]$ such that

$$(2) \quad -\rho \nabla \frac{\delta \mathcal{E}}{\delta \rho} = \nabla \cdot S.$$

one obtains the relative energy identity

$$(3) \quad \begin{aligned} \frac{d}{dt} \left(\mathcal{E}(\rho|\bar{\rho}) + \int \frac{1}{2} \rho |u - \bar{u}|^2 dx \right) \\ = \int \nabla \bar{u} : S(\rho|\bar{\rho}) dx - \int \rho \nabla \bar{u} : (u - \bar{u}) \otimes (u - \bar{u}) dx, \end{aligned}$$

Hypothesis (2) holds for many systems of interest as a consequence of Noether’s theorem and the invariance of the functional $\mathcal{E}[\rho]$ under translations $\rho \rightarrow \rho(\cdot + h)$.

Examples fit under this framework include the Euler equations, the Quantum Hydrodynamics system, and the Euler-Poisson system, [1].

This framework is useful in studying the diffusive limit from

$$(4) \quad \begin{aligned} \frac{\partial \rho}{\partial t} + \operatorname{div}(\rho u) &= 0 \\ \varepsilon^2 \rho \left(\frac{\partial u}{\partial t} + (u \cdot \nabla) u \right) &= -\rho \nabla \frac{\delta \mathcal{E}}{\delta \rho}(\rho) - \rho u \end{aligned}$$

as $\varepsilon \rightarrow 0$, to

$$(5) \quad \partial_t \rho = \nabla \cdot \rho \nabla \frac{\delta \mathcal{E}}{\delta \rho}.$$

Recall that (4) stands for a scaled high-friction limit of the Euler system while (5) is a gradient flow in Wasserstein distance, [5], and covers several interesting systems like porous media, Keller-Segel, and Cahn-Hilliard type equations. The validation of the diffusive limit $\varepsilon \rightarrow 0$ from (4) to (5) is discussed in [3] and references therein, see also [2] for an application on phase transition problems.

Another application of the relative energy arises in modeling of isothermal multi-component flows, with partial densities ρ_i and partial velocities v_i . Consider

$$(6) \quad \begin{cases} \partial_t \rho_i + \operatorname{div}(\rho_i v_i) = 0 \\ \partial_t(\rho_i v_i) + \operatorname{div}(\rho_i v_i \otimes v_i) = -\rho_i \nabla \frac{\delta \mathcal{E}}{\delta \rho_i} - \frac{1}{\varepsilon} \sum_j b_{ij} \rho_i \rho_j (v_i - v_j) \end{cases}$$

describing the evolution of $(\rho_1, \dots, \rho_n, v_1, \dots, v_n)$, where the dynamics is generated by a functional

$$\mathcal{E}(\rho_1, \dots, \rho_n) = \int \sum_i h(\rho_i) + \sum_i \frac{1}{2} \kappa(\rho_i) |\nabla \rho_i|^2$$

covering both classical and quantum fluids. The system admits the (formal) energy dissipation equation

$$(7) \quad \frac{d}{dt} \left(\mathcal{E}(\rho) + \int \sum_i \frac{1}{2} \rho_i |v_i|^2 \right) + \frac{1}{2\varepsilon} \int \sum_{i,j} b_{i,j} \rho_i \rho_j |v_1 - v_j|^2 = 0$$

where the last term captures the damping effect of the friction.

We are interested in calculating an effective equation valid in the high friction limit $\varepsilon \rightarrow 0$. This process is expressed in terms of the moments $\rho = \sum \rho_i$, $\rho v = \sum_i \rho_i v_i$, and the relative velocities $u_i := v_i - v$, where ρ is the total density and v the barycentric velocity. Performing the Chapman-Enskog asymptotic expansion, the effective equation is calculated in the form of a hyperbolic-parabolic

or hyperbolic-dispersive system of the form

$$(8) \quad \begin{cases} \partial_t \rho_i + \operatorname{div}(\rho_i v) = \varepsilon \operatorname{div} \sum_{j=1}^n D_{ij} \nabla \frac{\delta \mathcal{E}}{\delta \rho_j} \\ \partial_t(\rho v) + \operatorname{div}(\rho v \otimes v) = - \sum_{i=1}^n \rho_i \nabla \frac{\delta \mathcal{E}}{\delta \rho_i} \end{cases},$$

where the diffusion matrix $D^{n \times n} = GQ^{-1}(\rho)\tau^{-1}Q^{-1}(\rho)G^T$, $D \geq 0$ is positive semi-definite. The total density satisfies the conservation equation

$$\partial_t \sum \rho_i + \operatorname{div}(\sum \rho_i v) = 0$$

and (8) is endowed with the energy dissipation structure

$$(9) \quad \partial_t \left(\mathcal{E}[\rho] + \int \frac{1}{2} (\sum_i \rho_i) |v|^2 dx \right) + \varepsilon \int \sum_{ij} \nabla \frac{\delta \mathcal{E}}{\delta \rho_i} D_{ij} \nabla \frac{\delta \mathcal{E}}{\delta \rho_j} = 0.$$

The system (8) is an effective equation describing the dynamics of the multi-component flow (6) up to order $O(\varepsilon^2)$. The rigorous validation of this asymptotic behavior is achieved in [4] using the technical tool of relative energy for the comparison of the two systems.

To understand the nature of the limiting system, consider (8) for the special case of $v = 0$ barycentric velocity. Then $\partial_t \rho = 0$ and $\rho = \sum_i \rho_i = \text{const}$. Setting $\tilde{\rho} = (\rho_1, \dots, \rho_{n-1})$, $\rho_n = \rho - \sum_{i=1}^{n-1} \rho_i$, $\tilde{\mathcal{E}}(\rho_1, \dots, \rho_{n-1}) := \mathcal{E}(\rho_1, \dots, \rho_{n-1}, \rho - \sum_{i=1}^{n-1} \rho_i)$, it turns out [4] that we can write (8) (for $v = 0$) in the form

$$(10) \quad \partial_t \tilde{\rho}_i = \operatorname{div} \left(\sum_{j=1}^{n-1} \tilde{D}_{ij} \nabla \frac{\delta \tilde{\mathcal{E}}}{\delta \rho_j} \right), \quad i = 1, \dots, n-1,$$

where $\tilde{D}^{(n-1) \times (n-1)} > 0$ and (10) is a gradient flow,

$$\frac{d\tilde{\mathcal{E}}}{dt} = -\varepsilon \int \int \sum_{ij} \nabla \frac{\delta \mathcal{E}}{\delta \rho_i} \cdot \tilde{D}_{ij} \nabla \frac{\delta \mathcal{E}}{\delta \rho_j}$$

and is parabolic, i.e. the eigenvalues of $\tilde{D}\mathcal{E}''$ are real and positive.

REFERENCES

- [1] J. Giesselmann, C. Lattanzio and A.E. Tzavaras, *Relative entropy for the Korteweg theory and related Hamiltonian flows in gas dynamics* Arch. Rational Mech. Anal. **223** (2017), 1427-1484.
- [2] J. Giesselmann and A.E. Tzavaras, *Stability properties of the Euler-Korteweg system with nonmonotone pressures*. Appl. Analysis **96** (2017), 1528 - 1546.
- [3] C. Lattanzio and A.E. Tzavaras, *From gas dynamics with large friction to gradient flows describing diffusion theories*. Comm. Partial Differential Equations **42** (2017), 261-290.
- [4] Xiaokai Huo, Ansgar Jüngel and Athanasios E. Tzavaras, *High friction limits of Euler flows for multicomponent systems*. Nonlinearity (to appear).
- [5] Felix Otto. *The geometry of dissipative evolution equations: the porous medium equation*. Comm. Partial Differential Equations, **26** (2001), 101–174.

A Sufficient Condition for the Kolmogorov 4/5 Law for Stationary Martingale Solutions to the 3D Navier-Stokes Equations

FRANZISKA WEBER

(joint work with Jacob Bedrossian, Michele Coti Zelati, Samuel Punshon-Smith)

We consider the stochastically forced Navier-Stokes equations on \mathbb{T}^3

$$(NSE) \quad \begin{cases} \partial_t u + u \cdot \nabla u + \nabla p - \nu \Delta u = \partial_t W, \\ \operatorname{div} u = 0, \end{cases}$$

describing the motion of a viscous, incompressible fluid on a periodic domain. The forcing is assumed to be a mean zero, white-in-time and colored-in-space Gaussian process, represented by

$$W(t, x) = \sum_{k=1}^{\infty} \sigma_k e_k(x) \beta_k(t),$$

where $\{\beta_k(t)\}$ are independent 1D Brownian motions, $\{e_k\}$ are orthonormal eigenfunctions of the Stokes operator on \mathbb{T}^3 , and $\{\sigma_k\}$ are fixed constants satisfying

$$\varepsilon := \frac{1}{2} \sum_{k=1}^{\infty} |\sigma_k|^2 < \infty.$$

The parameter $\nu > 0$ plays the role of the inverse Reynolds number while the quantity ε plays the role of the mean energy input by the noise. The energy input ε is assumed to be independent of the Reynolds number. We are interested in (weak) *stationary martingale* solutions of (NSE), whose existence was proved in [5]. Martingale solutions are the stochastic counterpart of Leray-Hopf solutions in the deterministic setting, and stationary refers to the property that the paths $u(\cdot + \tau)$ and $u(\cdot)$ coincide in law for each $\tau > 0$. Stationary martingale solutions satisfy the energy inequality

$$(1) \quad \mathbf{E} \nu \|\nabla u\|_{L_x^2}^2 \leq \varepsilon.$$

The theory of turbulence, put forward in the 1930s and 1940s by Taylor, Richardson, Kolmogorov and others (see [6] and the references therein), revolutionized classical physics and has been widely influential in fluid mechanics, atmospheric and ocean sciences, and plasma physics. In the sequence of papers [10, 9, 11], usually referred to as *K41*, Kolmogorov took three basic axioms about the fluid flow and formally derived several predictions about the statistics of the flow. One of the axioms he assumed is not supported by experimental studies, which results in deviations from some of the predictions of the classical theory due to what is now commonly referred to as *intermittency*; see e.g. [12, 1, 7, 13, 6, 8] and the references therein. In particular, real flows are observed to lack statistical self-similarity. Intermittency is also connected to the rare events/large deviations from the average behavior. Nevertheless, the Kolmogorov 4/5 law, described below, is independent of the problematic axiom and matches very well with experiments. In fact, it is regarded as an ‘exact’ law of turbulence by the physics community.

The 4/5 law. Assuming that the flow is isotropic, statistically stationary in space and time, and satisfies a suitable *anomalous dissipation* assumption, Kolmogorov made the prediction that over a range of scales $|h| \in [\ell_D, \ell_I]$ with $\ell_D \approx \varepsilon^{-1/4} \nu^{3/4}$, the following 4/5 law holds for the flow velocity field u

$$(2) \quad \mathbf{E} \left(\delta_h u \cdot \frac{h}{|h|} \right)^3 \sim -\frac{4}{5} \varepsilon |h|,$$

where $\delta_h u(x) := u(x+h) - u(x)$ is the increment by the vector $h \in \mathbb{R}^3$. The quantity appearing on the left-hand side above is referred to as the third-order longitudinal structure function. The range over which viscous effects will be mostly negligible, $[\ell_D, \ell_I]$, is commonly called the *inertial range*. The top scale ℓ_I , called the *integral scale*, is essentially the scale at which the external forcing acts, while ℓ_D , called the *dissipation scale*, is the scale where the viscosity dominates the flow.

Our goal is to mathematically rigorously derive the Kolmogorov 4/5 law and the closely related 4/3 law for solutions to (NSE) with minimal hypotheses. Since the 4/5 law is independent of the precise details of intermittency, it should be possible to prove it using very few hypotheses, and in particular, without requiring any additional regularity other than what follows from the energy inequality (1). In fact, we only need the additional assumption that the sequence of martingale solutions $\{u\}_{\nu>0}$ satisfies the following *weak anomalous dissipation* condition:

Definition 1 (Weak anomalous dissipation). *We say that a sequence $\{u\}_{\nu>0}$ of stationary martingale solutions satisfies weak anomalous dissipation if*

$$(WAD) \quad \lim_{\nu \rightarrow 0} \nu \mathbf{E} \|u\|_{L_x^2}^2 = 0.$$

In the physics literature, e.g. [6], it is usually implicitly assumed that $\mathbf{E} \|u\|_{L_x^2}^2$ is bounded independently of the Reynolds number, which would more closely match the idea that the energy input should be totally balanced uniformly in the Reynolds number. However, for solutions to (NSE), these stronger assertions are unnecessary to deduce the 4/5 law.

Remark 2. *It is an open problem to prove existence of solutions to the Navier-Stokes equations satisfying (WAD). However, an analogue of the weak anomalous dissipation condition can be proved for the passive scalar problem where the scalar is advected by a time-independent and weakly mixing velocity field [3], the velocity field given from the 2D Navier-Stokes equations, or the velocity field from the 3D hyperviscous Navier-Stokes equation with suitable nondegenerate noise [2].*

Denote for $h \in \mathbb{R}^3$ the increment of u with respect to the vector h by $\delta_h u(x) = u(x+h) - u(x)$. Then, we define for any $\ell \in \mathbb{R}$ the averaged structure functions

$$(3a) \quad S_0(\ell) = \frac{1}{4\pi} \mathbf{E} \int_{\mathbb{S}^2} \int_{\mathbb{T}^3} |\delta_{\ell \hat{n}} u|^2 \delta_{\ell \hat{n}} u \cdot \hat{n} dx dS(\hat{n}),$$

$$(3b) \quad S_{||}(\ell) = \frac{1}{4\pi} \mathbf{E} \int_{\mathbb{S}^2} \int_{\mathbb{T}^3} (\delta_{\ell \hat{n}} u \cdot \hat{n})^3 dx dS(\hat{n}).$$

Our main result reads as follows.

Theorem 1 (Averaged 4/3 and 4/5 laws). *Let $\{u\}_{\nu>0}$ be a sequence of stationary martingale solutions to (NSE), which satisfy (WAD), and let $S_0(\ell)$ and $S_{||}(\ell)$ be the corresponding structure functions as defined in (3). Then we have:*

- (4/3 law) *There exists $\ell_D = \ell_D(\nu)$ with $\lim_{\nu \rightarrow 0} \ell_D = 0$ such that*

$$\lim_{\ell_I \rightarrow 0} \limsup_{\nu \rightarrow 0} \sup_{\ell \in [\ell_D, \ell_I]} \left| \frac{S_0(\ell)}{\ell} + \frac{4}{3}\varepsilon \right| = 0.$$

- (4/5 law) *There exists $\ell_D = \ell_D(\nu)$ with $\lim_{\nu \rightarrow 0} \ell_D = 0$ such that*

$$\lim_{\ell_I \rightarrow 0} \limsup_{\nu \rightarrow 0} \sup_{\ell \in [\ell_D, \ell_I]} \left| \frac{S_{||}(\ell)}{\ell} + \frac{4}{5}\varepsilon \right| = 0.$$

REFERENCES

- [1] F. Anselmet, Y. Gagne, E. Hopfinger, R. Antonio, *High-order velocity structure functions in turbulent shear flows*, Journal of Fluid Mechanics **140** (1984), 63-89.
- [2] J. Bedrossian, A. Blumenthal, S. Punshon-Smith, *Lagrangian chaos and scalar advection in stochastic fluid mechanics*, arXiv preprint (2018).
- [3] J. Bedrossian, M. Coti Zelati, N. Glatt-Holtz, *Invariant measures for passive scalars in the small noise inviscid limit*, Communications in Mathematical Physics **348** (2016), 101-127.
- [4] J. Bedrossian, M. Coti Zelati, S. Punshon-Smith, and F. Weber, *A sufficient condition for the Kolmogorov 4/5 law for stationary martingale solutions to the 3D Navier-Stokes equations*, Communications in Mathematical Physics **367** (2019), 1045-1075.
- [5] F. Flandoli, D. Gatarek, *Martingale and stationary solutions for stochastic Navier-Stokes equations*, Probability Theory and Related Fields **102** (1995), 367-391.
- [6] U. Frisch, *Turbulence*, Cambridge University Press, Cambridge (1995).
- [7] U. Frisch, G. Parisi, *Fully developed turbulence and intermittency*, Turbulence and predictability in geophysical fluid dynamics and climate dynamics **88** (1985), 71-88.
- [8] Y. Kaneda, T. Ishihara, M. Yokokawa, K. Itakura, A. Uno, *Energy dissipation rate and energy spectrum in high resolution direct numerical simulations of turbulence in a periodic box*, Physics of Fluids **15** (2003), L21-L24.
- [9] A. N. Kolmogorov, *Dissipation of energy in the locally isotropic turbulence*, C. R. (Doklady) Acad. Sci. URSS (N.S.) **32** (1941), 16-18.
- [10] A. N. Kolmogorov, *The local structure of turbulence in incompressible viscous fluid for very large Reynold's numbers*, C. R. (Doklady) Acad. Sci. URSS (N.S.) **30** (1941), 301-305.
- [11] A. N. Kolmogorov, *On degeneration of isotropic turbulence in an incompressible viscous liquid*, C. R. (Doklady) Acad. Sci. URSS (N. S.) **31** (1941), 538-540.
- [12] A. N. Kolmogorov, *A refinement of previous hypotheses concerning the local structure of turbulence in a viscous incompressible fluid at high Reynolds number*, Journal of Fluid Mechanics **13** (1962), 82-85.
- [13] K. R. Sreenivasan, P. Kailasnath, *An update on the intermittency exponent in turbulence*, Physics of Fluids A: Fluid Dynamics **5** (1993), 512-514.

Uncertainty Quantification for Cloud Simulation

BETTINA WIEBE

(joint work with Alina Chertock, Alexander Kurganov, Maria Lukáčová-Medvid'ová, Peter Spichtinger)

Clouds constitute one of the most important component in the Earth-atmosphere system. They influence the hydrological cycle and by interacting with radiation they control the energy budget of the system. However, clouds are one of the most uncertain components, which, unlike the atmospheric flows, cannot be modeled using first principles of physics.

We develop a stochastic Galerkin method for a coupled Navier-Stokes-cloud system consisting of the weakly compressible Navier-Stokes equations and random cloud evolution equations for water vapor, cloud water and rain that models dynamics of warm clouds, see [3]. In this model the Navier-Stokes equations describe weakly compressible flows with viscous and heat conductivity effects, while microscale cloud physics is modeled by the system of advection-diffusion-reaction equations. Our goal is to explicitly describe the evolution of uncertainties that arise due to unknown input data, such as model parameters and initial or boundary conditions and investigate the influence on atmospheric flows. The developed stochastic Galerkin method combines the space-time approximation obtained by a suitable finite volume method with a spectral-type approximation based on the generalized polynomial chaos expansion in the stochastic space, see [1].

Since the largest source of uncertainties is cloud physics, we restrict our consideration to the case in which the uncertainties are only in the cloud physics representation. Thus, we solve the deterministic Navier-Stokes equations coupled with the PDE system for the generalized polynomial chaos (gPC) expansion coefficients for the cloud variables. Our numerical method is an extension of the approach proposed in [2] for the purely deterministic version of the coupled Navier-Stokes-cloud system. This method is based on the operator splitting approach, in which the system is split into the macroscopic Navier-Stokes equations and microscopic cloud model with random inputs. The Navier-Stokes equations are then solved by an asymptotic preserving implicit-explicit (IMEX) finite-volume method, while for the cloud equations we develop a stochastic Galerkin method based on the gPC. The resulting gPC coefficient system is numerically solved by a finite-volume method combined with an explicit Runge-Kutta method with an enlarged stability region. The resulting numerical scheme yields a second-order accurate approximation in both space and time and exponential convergence in the stochastic space. Our numerical results demonstrate the reliability and robustness of the stochastic Galerkin method. We also use the proposed method to study the behavior of clouds in certain perturbed scenarios, for examples, the ones leading to changes in macroscopic cloud pattern as a shift from hexagonal to rectangular structures.

Acknowledgement

The research leading to these results has been done within the sub-project A2 of the Transregional Collaborative Research Center SFB/TRR 165 “Waves to Weather” funded by the German Science Foundation (DFG).

REFERENCES

- [1] A. Chertock, A. Kurganov, M. Lukáčová-Medvid'ová, P. Spichtinger, B. Wiebe, *Stochastic Galerkin method for cloud simulation*, Math. Clim. Weather Forecast (submitted).
- [2] M. Lukáčová-Medvid'ová, J. Rosemeier, P. Spichtinger, B. Wiebe, *IMEX finite volume methods for cloud simulation*, Finite volumes for complex applications VIII—hyperbolic, elliptic and parabolic problems, Springer Proc. Math. Stat. **200** (2017), 179–187.
- [3] N. Porz, M. Hanke, M. Baumgartner, P. Spichtinger *A model for warm clouds with implicit droplet activation, avoiding saturation adjustment*, Math. Clim. Weather Forecast. **4** (2018), 50–78.

Undercompressive Shock Waves in Anti-Plane Shear Dynamics

MARIA WIEBE

(joint work with Christian Rohde)

In this contribution we study hyperbolic problems

$$(1) \quad \partial_t \mathbf{u} + \nabla \cdot \mathbf{f}(\mathbf{u}) = 0 \quad \text{in } [0, T) \times \mathbb{R}^d, \mathbf{u} \in \mathcal{U} \subseteq \mathbb{R}^s,$$

where \mathbf{f} has linearly degenerated or genuinely nonlinear characteristic fields only. We assume that the state space \mathcal{U} is a union of two or more *disjoint* convex sets \mathcal{U}_i , $i \geq 2$, in the most simple case

$$(2) \quad \mathcal{U} = \mathcal{U}_1 \cup \mathcal{U}_2.$$

Problem (1), (2) may allow solutions with so called undercompressive shock waves, also termed as nonclassical shock waves, that fulfill the standard entropy criterion but not the Lax entropy criterion. As a consequence, solutions are not uniquely determined by the entropy condition. In classical theories uniqueness is usually enforced by an additional algebraic coupling condition called kinetic relation [1], [2] or in recent approaches by suitable mesoscale models [5].

Undercompressive shock waves arise in many physical processes, which involve multiple phases, and require sophisticated numerical methods. In [3] we proposed a Front-Capturing Finite Volume method in two or three space dimensions to approximate weak solutions of systems of conservation laws that contain undercompressive shock waves. The Front-Capturing method relies on a moving mesh ansatz such that the undercompressive wave is represented by mesh edges as a sharp interface without any artificial smearing.

In the following, we examine the model of anti-plane shear dynamics of an elastic crystalline solid. We consider the crystalline solid in an open cross-section plane $\Omega \subseteq \mathbb{R}^2$ and assume that it is deformed in out-of-plane direction only. We

therefore write the deformation as $\mathbf{w} = (0, 0, u(x_1, x_2, t))^T$ where u is governed by the wave equation

$$(3) \quad \partial_{tt}u - \nabla \cdot \boldsymbol{\sigma}(\nabla u) = 0, \quad \text{in } \Omega \times (0, T),$$

for $T > 0$. Rewriting the system in terms of velocity $v := u_t$ and strain $\boldsymbol{\gamma} = (\boldsymbol{\gamma}^{(1)}, \boldsymbol{\gamma}^{(2)})^T := \nabla u$ gives the hyperbolic system

$$(4) \quad \partial_t \begin{pmatrix} \boldsymbol{\gamma} \\ v \end{pmatrix} + \nabla \cdot \begin{pmatrix} -v \\ -\boldsymbol{\sigma}(\boldsymbol{\gamma}) \end{pmatrix} = 0, \quad \text{in } \Omega \times (0, T).$$

The stress-strain relation is given as $\boldsymbol{\sigma} = \nabla W$ for a stored energy function $W : \mathbb{R}^2 \rightarrow \mathbb{R}$. Material phases are usually modelled by a non-convex function W [4] such that the system (4) is of mixed hyperbolic-elliptic type.

Writing problem (4) for a given direction $\mathbf{n} \in \mathcal{S}^1$, $\xi = \mathbf{x} \cdot \mathbf{n}$ gives the 1-dimensional system

$$(5) \quad \partial_t \begin{pmatrix} \boldsymbol{\gamma} \\ v \end{pmatrix} + \partial_\xi \begin{pmatrix} -v\mathbf{n} \\ -\boldsymbol{\sigma}(\boldsymbol{\gamma}) \cdot \mathbf{n} \end{pmatrix} = 0.$$

As a first approach for exploring system (4), we consider Riemann problems of the associated 1-dimensional system (5). System (5) possesses the characteristic fields

$$(6) \quad \lambda_1 = -\sqrt{\mathbf{n}^T \mathbf{D}\boldsymbol{\sigma}(\boldsymbol{\gamma})\mathbf{n}}, \quad \lambda_2 = 0, \quad \lambda_3 = \sqrt{\mathbf{n}^T \mathbf{D}\boldsymbol{\sigma}(\boldsymbol{\gamma})\mathbf{n}},$$

and is strictly hyperbolic for $\mathcal{U} = \{(\boldsymbol{\gamma}, v) \in \mathbb{R}^2 \times \mathbb{R} : \mathbf{n}^T \mathbf{D}\boldsymbol{\sigma}(\boldsymbol{\gamma})\mathbf{n} > 0\}$.

The Rankine–Hugoniot sets are denoted in the following by $S_1(\mathbf{u}_-)$, $S_2(\mathbf{u}_-)$, $S_3(\mathbf{u}_-)$ with velocities $s_1 = -\sqrt{\frac{[\![\boldsymbol{\sigma}(\boldsymbol{\gamma})]\!] \cdot \mathbf{n}}{\varepsilon}}$, $s_2 = 0$, and $s_3 = \sqrt{\frac{[\![\boldsymbol{\sigma}(\boldsymbol{\gamma})]\!] \cdot \mathbf{n}}{\varepsilon}}$ respectively.

$$S_{1/3}(\mathbf{u}_-) = \left\{ (\boldsymbol{\gamma}_+, v_+) \in \mathcal{U} : \begin{aligned} &\exists \varepsilon \geq 0 : \boldsymbol{\gamma}_+ = \boldsymbol{\gamma}_- + \varepsilon\mathbf{n}, v_+ = v_- \pm \sqrt{[\![\boldsymbol{\sigma}(\boldsymbol{\gamma})]\!] \cdot \mathbf{n}\varepsilon}, \\ &\exists \varepsilon < 0 : \boldsymbol{\gamma}_+ = \boldsymbol{\gamma}_- + \varepsilon\mathbf{n}, v_+ = v_- \mp \sqrt{[\![\boldsymbol{\sigma}(\boldsymbol{\gamma})]\!] \cdot \mathbf{n}\varepsilon} \end{aligned} \right\},$$

$$S_2(\mathbf{u}_-) = \left\{ (\boldsymbol{\gamma}, v) \in \mathcal{U} : v_+ = v_-, [\![\boldsymbol{\sigma}(\boldsymbol{\gamma})]\!] \cdot \mathbf{n} = 0 \right\}.$$

The rarefaction curves are denoted by $R_1(\mathbf{u}_-)$, $R_2(\mathbf{u}_-)$, and $R_3(\mathbf{u}_-)$ for rarefaction waves associated to the characteristic fields λ_1 , λ_2 , and λ_3 respectively.

$$R_{1/3}(\mathbf{u}_-) = \left\{ (\boldsymbol{\gamma}_+, v_+) \in \mathcal{U} : \begin{aligned} &\exists \varepsilon \leq 0 : \boldsymbol{\gamma}_+ = \boldsymbol{\gamma}_- \pm \varepsilon\mathbf{n}, \\ &v_+ = v_- - \int_\varepsilon^0 \sqrt{\mathbf{n}^T \mathbf{D}\boldsymbol{\sigma}(\boldsymbol{\gamma}_- \pm r\mathbf{n})\mathbf{n}} dr \end{aligned} \right\},$$

$$R_2(\mathbf{u}_-) = \left\{ \mathbf{u}_- \right\}.$$

It is well known that restricting all above mentioned wave sets to the entropy-admissible subset only, results locally around \mathbf{u}_- in a union of three curves that run through \mathbf{u}_- . Globally, we get a different picture: all Rankine-Hugoniot sets $S_1(\mathbf{u}_-)$, $S_2(\mathbf{u}_-)$ and $S_3(\mathbf{u}_-)$ decompose into entropy-admissible sub-curves. The

resulting shocks then may be of classical type (Lax shocks, contact discontinuities) or undercompressive (i.e. not fulfilling the Lax entropy condition).

For simplicity we assume in the following that W is a double-well function, i.e. the material admits two different phases. Each Rankine–Hugoniot set then decomposes into two subcurves:

$$\begin{aligned} S_1(\mathbf{u}_-) &= S_{-,loc}^c(\mathbf{u}_-) \cup S_{-,nonloc}^u(\mathbf{u}_-), \\ S_2(\mathbf{u}_-) &= S_{0,loc}^c(\mathbf{u}_-) \cup S_{0,nonloc}^c(\mathbf{u}_-), \\ S_3(\mathbf{u}_-) &= S_{+,loc}^c(\mathbf{u}_-) \cup S_{+,nonloc}^u(\mathbf{u}_-). \end{aligned}$$

The indices c and u denote classical and undercompressive shocks, respectively. The subindices $+$, 0 , and $-$ denote negative, zero and positive velocities of the shock curves, whereas *loc* and *nonloc* denote the curves through and not through \mathbf{u}_- respectively. We rearrange these sets into *single, continuous* curves

$$\begin{aligned} C_-(\mathbf{u}_-) &= R_1(\mathbf{u}_-) \cup S_{-,loc}^c(\mathbf{u}_-), && \text{(classical waves associated to } \lambda_1) \\ S_{-,nonloc}^u(\mathbf{u}_-), &&& \text{(underc. waves with negative speed)} \\ S_{0,loc}^c(\mathbf{u}_-), &&& \text{(classical waves associated to } \lambda_2) \\ S_{0,nonloc}^c(\mathbf{u}_-), &&& \text{(classical waves associated to } \lambda_2) \\ S_{+,nonloc}^u(\mathbf{u}_-), &&& \text{(underc. waves with positive speed)} \\ C_+(\mathbf{u}_-) &= R_3(\mathbf{u}_-) \cup S_{+,loc}^c(\mathbf{u}_-). && \text{(classical waves associated to } \lambda_3) \end{aligned}$$

Each of the sets above can therefore be parametrized by a *single, continuous* parameter. This enables us to construct solutions of the Riemann problem. Since the three nonlocal curves do not contain \mathbf{u}_- , we have to consider different *configurations* when solving the Riemann problem. Let us consider two different configurations. The first configuration represents the classical one-phase Riemann solution and is given (with some abuse of notation) as

$$C_-(\mathbf{u}_-) \xrightarrow{\varepsilon_1} S_{0,loc}^c(\cdot) \xrightarrow{\varepsilon_2} C_+(\cdot) \xrightarrow{\varepsilon_3} \mathbf{u}_+.$$

The second configuration represents the case of two phase-transitions, one with negative and one with zero speed

$$C_-(\mathbf{u}_-) \xrightarrow{\varepsilon_1} S_{-,nonloc}^u(\cdot) \xrightarrow{\varepsilon_2} S_{0,nonloc}^c(\cdot) \xrightarrow{\varepsilon_3} C_+(\cdot) \xrightarrow{\varepsilon_4} \mathbf{u}_+ + \text{additional conditions.}$$

In general, the number of configurations is not limited and depends of the choice of the additional conditions (kinetic relations and nucleation conditions). Future investigations are dedicated to the following questions:

- Which additional conditions are suitable in the sense that the Riemann problem for (5) is wellposed? Especially: Is a finite number of configurations necessary for the uniqueness of the Riemann solution?
- Which conclusions may be drawn for the general Cauchy problem for (4)?
- From practical point of view: How to find the right configuration when solving the Riemann problem numerically?

REFERENCES

- [1] P. G. LeFloch and M. D. Thanh, *Non-classical Riemann solvers and kinetic relations. II. A hyperbolic-elliptic model of phase-transition dynamics*, Proceedings of the Royal Society of Edinburgh **132:1** (2002), 181–219.
- [2] R. Abeyaratne and J. K. Knowles, *Kinetic relations and the propagation of phase boundaries in solids*, Arch. Rational Mech. Anal. **114:2** (1991), 119–154.
- [3] C. Chalons, C. Rohde, and M. Wiebe, *A Finite Volume Method for Undercompressive Shock Waves in Two Space Dimensions*, ESAIM Math. Model. Numer. Anal. **51:5** (2017), 1987–2015.
- [4] P. Rosakis and H. Tsai, *Dynamic twinning processes in crystals*, Intl. J. Solids Struct. **32:17** (1995), 2711–2723
- [5] J. Magiera and C. Rohde, *A Particle-based Multiscale Solver for Compressible Liquid-Vapor Flow*, Springer Proc. Math. Stat. (2018), 291–304

Participants

Prof. Dr. Debora Amadori
Dipartimento di Matematica
Università degli Studi dell'Aquila
Via Vetoio, 1
67010 L'Aquila
ITALY

Prof. Dr. Sylvie Benzoni-Gavage
Institut Camille Jordan
Université Claude Bernard Lyon 1
43 blvd. du 11 novembre 1918
69622 Villeurbanne Cedex
FRANCE

Prof. Dr. Stefano Bianchini
SISSA - ISAS
Via Bonomea 265
34136 Trieste
ITALY

Prof. Dr. Francois Bouchut
LAMA - UMR 8050
Université Paris-Est, Marne-la-Vallée
Cité Descartes, Champs-sur-Marne
5, Boulevard Descartes
77454 Marne-la-Vallée Cedex 2
FRANCE

Prof. Alberto Bressan
Department of Mathematics
Pennsylvania State University
University Park PA 16802
UNITED STATES

Dr. Yangyang Cao
Laboratoire Jacques-Louis Lions
Université Pierre et Marie Curie
4, Place Jussieu
75005 Paris Cedex
FRANCE

Prof. Dr. Christophe Chalons
Laboratoire de Mathématiques de
Versailles
Université Versailles SQY
45, avenue des Etats Unis
78000 Versailles Cedex
FRANCE

Prof. Dr. Alina Chertock
Department of Mathematics
North Carolina State University
Campus Box 8205
Raleigh, NC 27695-8205
UNITED STATES

Felisia Angela Chiarello
INRIA - Team ACUMES
BP 93
2004, route des Lucioles
06902 Sophia-Antipolis Cedex
FRANCE

Prof. Dr. Rinaldo M. Colombo
INdAM Unit - c/o DII
Università degli Studi di Brescia
Via Branze, 38
25123 Brescia
ITALY

Prof. Dr. Gianluca Crippa
Departement Mathematik und
Informatik
Universität Basel
Spiegelgasse 1
4051 Basel
SWITZERLAND

Prof. Dr. Constantine M. Dafermos
Division of Applied Mathematics
Brown University
Box F
182 George Street
Providence, RI 02912
UNITED STATES

Dr. Sara Daneri
Gran Sasso Science Institute (GSSI)
Viale Francesco Crispi, 7
67100 L'Aquila
ITALY

Prof. Dr. Heinrich Freistühler
Fachbereich Mathematik und Statistik
Universität Konstanz
Universitätsstrasse 10
78457 Konstanz
GERMANY

Prof. Dr. Mauro Garavello
Dipartimento di Matematica e Applicazioni
Università di Milano-Bicocca
Edificio U5
Via Roberto Cozzi 55
20125 Milano
ITALY

Prof. Dr. Jan Giesselmann
Fachbereich Mathematik
Technische Universität Darmstadt
Dolivostrasse 15
64293 Darmstadt
GERMANY

Dr. Paola Goatin
INRIA - Team ACUMES
BP 93
2004, route des Lucioles
06902 Sophia-Antipolis Cedex
FRANCE

Prof. Dr. Graziano Guerra
Dipartimento di Matematica e Applicazioni
Università di Milano-Bicocca
Edificio U5
Via Roberto Cozzi 55
20125 Milano
ITALY

Andrea Hanke
Aachen Institute for Advanced Study in Computational Engineering Science (AICES)
RWTH Aachen
Schinkelstrasse 2
52062 Aachen
GERMANY

Prof. Dr. Michael Herty
LuF Continuous Optimization
IGPM - 114620
RWTH Aachen University
Templergraben 55
52062 Aachen
GERMANY

Prof. Dr. Eun Heui Kim
Department of Mathematics and Statistics
California State University, Long Beach
1250 Bellflower Boulevard
Long Beach, CA 90840
UNITED STATES

Prof. Dr. Christian Klingenberg
Institut für Mathematik
Universität Würzburg
Emil-Fischer-Strasse 40
97074 Würzburg
GERMANY

Prof. Dr. Dietmar Kröner
Abteilung für Angewandte Mathematik
Universität Freiburg
Hermann-Herder-Strasse 10
79104 Freiburg i. Br.
GERMANY

Sam G. Krupa

Department of Mathematics
The University of Texas at Austin
1 University Station C1200
Austin, TX 78712-1082
UNITED STATES

Prof. Dr. Alexander Kurganov

Department of Mathematics
Southern University of Science and
Technology (SUSTech)
1088 Xueyuan Ave. Nanshan
Shenzhen, Guangdong Province 518 055
CHINA

Prof. Dr. Philippe G. LeFloch

Laboratoire Jacques-Louis Lions
Sorbonne Université
4, Place Jussieu
75252 Paris Cedex 05
FRANCE

Prof. Dr. Yachun Li

School of Mathematical Sciences
Shanghai Jiao Tong University
Shanghai 200 240
CHINA

Prof. Dr. Tai-Ping Liu

Institute of Mathematics
Academia Sinica
No. 128, Section 2
Academia Road, Nankang District
Taipei City 11529
TAIWAN

Prof. Dr. Mária**Lukáčová-Medvidová**

Institut für Mathematik
Johannes Gutenberg-Universität Mainz
Staudingerweg 9
55128 Mainz
GERMANY

Prof. Dr. Pierangelo Marcati

Gran Sasso Science Institute (GSSI)
Viale Francesco Crispi, 7
67100 L'Aquila
ITALY

Prof. Dr. Francesca Marcellini

Dipartimento di Matematica e
Applicazioni
Università di Milano-Bicocca
Edificio U5
Via Roberto Cozzi 53
20125 Milano
ITALY

Dr. Sandra May

Fakultät für Mathematik
Technische Universität Dortmund
Vogelpothsweg 87
44227 Dortmund
GERMANY

Prof. Dr. Vincent Perrollaz

Laboratoire de Mathématiques et
Physique
Théorique
Université de Tours
Parc de Grandmont
37200 Tours Cedex
FRANCE

Dr. Johanna Ridder

Department of Mathematics
Penn State University
212 McAllister Building
University Park PA 16802
UNITED STATES

Prof. Dr. Christian Rohde

Institut für Angewandte Analysis und
Numerische Simulation
Universität Stuttgart
Pfaffenwaldring 57
70569 Stuttgart
GERMANY

Dr. Elena Rossi

INRIA Sophia Antipolis
Team ACUMES
BP 93
2004, route des Lucioles
06902 Sophia-Antipolis Cedex
FRANCE

Prof. Dr. Denis Serre

UMPA
Ecole Normale Supérieure de Lyon
46, Allée d'Italie
69364 Lyon Cedex 07
FRANCE

Prof. Dr. Wen Shen

Department of Mathematics
Pennsylvania State University
223A McAllister Building
University Park, PA 16802
UNITED STATES

Prof. Dr. László Székelyhidi Jr.

Mathematisches Institut
Universität Leipzig
Postfach 10 09 20
04009 Leipzig
GERMANY

Prof. Dr. Eitan Tadmor

Center for Scientific Computation
and Mathematical Modeling (CSCAMM)
University of Maryland
CSIC Building # 406
Paint Branch Drive
College Park MD 20742-3289
UNITED STATES

Prof. Dr. Manuel Torrilhon

Aachen Institute for Advanced Study in
Computational Engineering Sciences
RWTH Aachen
Schinkelstrasse 2
52062 Aachen
GERMANY

Prof. Dr. Konstantina Trivisa

Department of Mathematics
University of Maryland
College Park, MD 20742-4015
UNITED STATES

Prof. Athanasios E. Tzavaras

Applied Mathematics and
Computational Sciences
4700 King Abdullah University of
Science
and Technology (KAUST)
Thuwal 23955-6900, Jeddah
SAUDI ARABIA

Prof. Dr. Gerald Warnecke

Fakultät für Mathematik
Institut für Analysis und Numerik
Otto-von-Guericke-Universität
Magdeburg
Universitätsplatz 2
39106 Magdeburg
GERMANY

Prof. Dr. Franziska Weber

Department of Mathematical Sciences
Carnegie Mellon University
5000 Forbes Avenue
Pittsburgh, PA 15213-3890
UNITED STATES

Bettina Wiebe

Institut für Mathematik
Johannes Gutenberg-Universität Mainz
Staudingerweg 9
55128 Mainz
GERMANY

Maria Wiebe

Institut für Angewandte Analysis und
Numerische Simulation
Universität Stuttgart
Pfaffenwaldring 57
70569 Stuttgart
GERMANY

